



US00D636119S

(12) **United States Design Patent**
Worlock

(10) **Patent No.:** **US D636,119 S**

(45) **Date of Patent:** **** Apr. 12, 2011**

(54) **HOLDER FOR LIGHTER AND CIGARETTE**

FOREIGN PATENT DOCUMENTS

(75) Inventor: **Paul Worlock**, Rome, NY (US)

FR 2386992 11/1978
JP 9047274 2/1997

(73) Assignee: **Put It Out, Inc.**, Rome, NY (US)

* cited by examiner

(**) Term: **14 Years**

Primary Examiner — Jennifer Rivard

(21) Appl. No.: **29/359,295**

(74) *Attorney, Agent, or Firm* — Shlesinger, Arkwright & Garvey LLP

(22) Filed: **Apr. 8, 2010**

(51) **LOC (9) Cl.** **27-05**

(57) **CLAIM**

(52) **U.S. Cl.** **D27/161; D27/172; D27/183**

The ornamental design for a holder for lighter and cigarette, as shown and described.

(58) **Field of Classification Search** 131/238,
131/235.1, 236, 256, 260; 206/85–89, 236,
206/240–241; 431/253; D27/172, 161, 183

See application file for complete search history.

DESCRIPTION

(56) **References Cited**

U.S. PATENT DOCUMENTS

1,928,041	A	9/1933	Windesheim	
2,309,011	A	1/1943	Porter	
2,619,092	A	11/1952	Ayers	
3,107,674	A	10/1963	Smith	
D277,034	S *	1/1985	Ramsdell	D27/187
4,588,076	A *	5/1986	Caputo et al.	206/86
D370,301	S *	5/1996	Murphy	D27/175
5,605,226	A	2/1997	Hernlein	
5,862,809	A	1/1999	Nicotra	
D405,223	S	2/1999	Vann	
5,934,894	A	8/1999	Cigler	
D420,169	S	2/2000	Cigler	
6,463,936	B1	10/2002	Hicks	
D522,689	S	6/2006	Bores et al.	
D527,139	S	8/2006	Deahl	
D565,790	S	4/2008	Eisman	
D567,437	S *	4/2008	Smith	D27/161
D586,953	S	2/2009	Riggio	
D617,495	S *	6/2010	LoRe	D27/172
D617,942	S *	6/2010	LoRe	D27/172
D618,392	S *	6/2010	LoRe	D27/172
2005/0051183	A1	3/2005	Coulthard	
2005/0236005	A1	10/2005	Bears et al.	
2006/0275726	A1	12/2006	Koropsak	
2007/0034216	A1	2/2007	Liu et al.	
2009/0145448	A1	6/2009	Worlock	

FIG. 1 is a front and right side perspective view of a holder for a lighter and cigarette according to my new design;
 FIG. 2 is top plan view of FIG. 1;
 FIG. 3 is left side elevational view of FIG. 1;
 FIG. 4 is a bottom plan view of FIG. 1;
 FIG. 5 is a rear elevational view of FIG. 1;
 FIG. 6 is a front elevational view of FIG. 1;
 FIG. 7 is a front and left side perspective view of a holder for a lighter and cigarette showing my new design with a lighter and cigarette shown in broken lines;
 FIG. 8 is a front and right side perspective view of a holder for a lighter and cigarette according to an alternative embodiment of my new design;
 FIG. 9 is top plan view of FIG. 8;
 FIG. 10 is left side elevational view of FIG. 8;
 FIG. 11 is a bottom plan view of FIG. 8;
 FIG. 12 is a rear elevational view of FIG. 8;
 FIG. 13 is a front elevational view of FIG. 8; and,
 FIG. 14 is a front and left side perspective view of a holder for a lighter and cigarette showing my new design with a lighter and cigarette shown in broken lines.
 Portions shown in broken lines form no part of the claimed design.

1 Claim, 8 Drawing Sheets

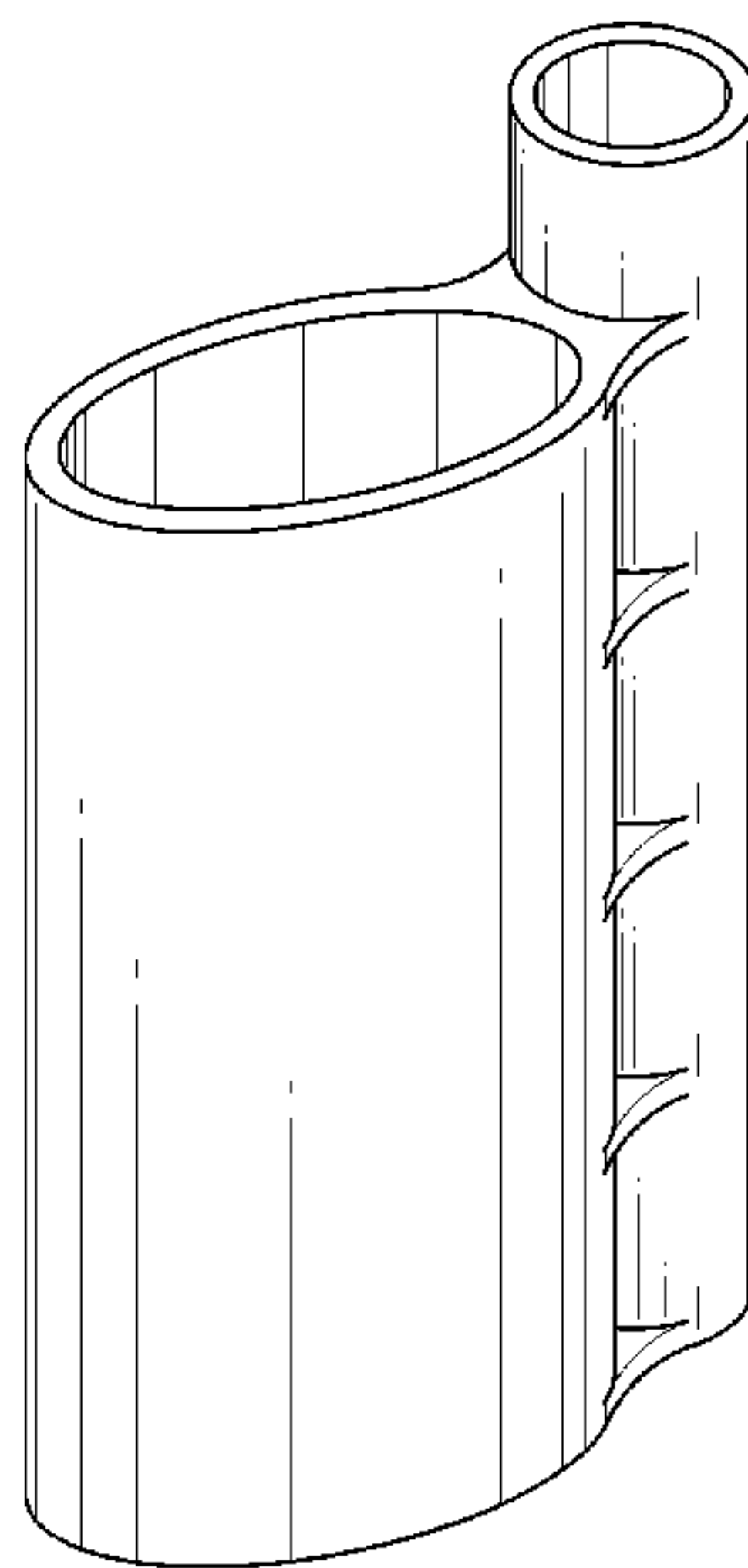

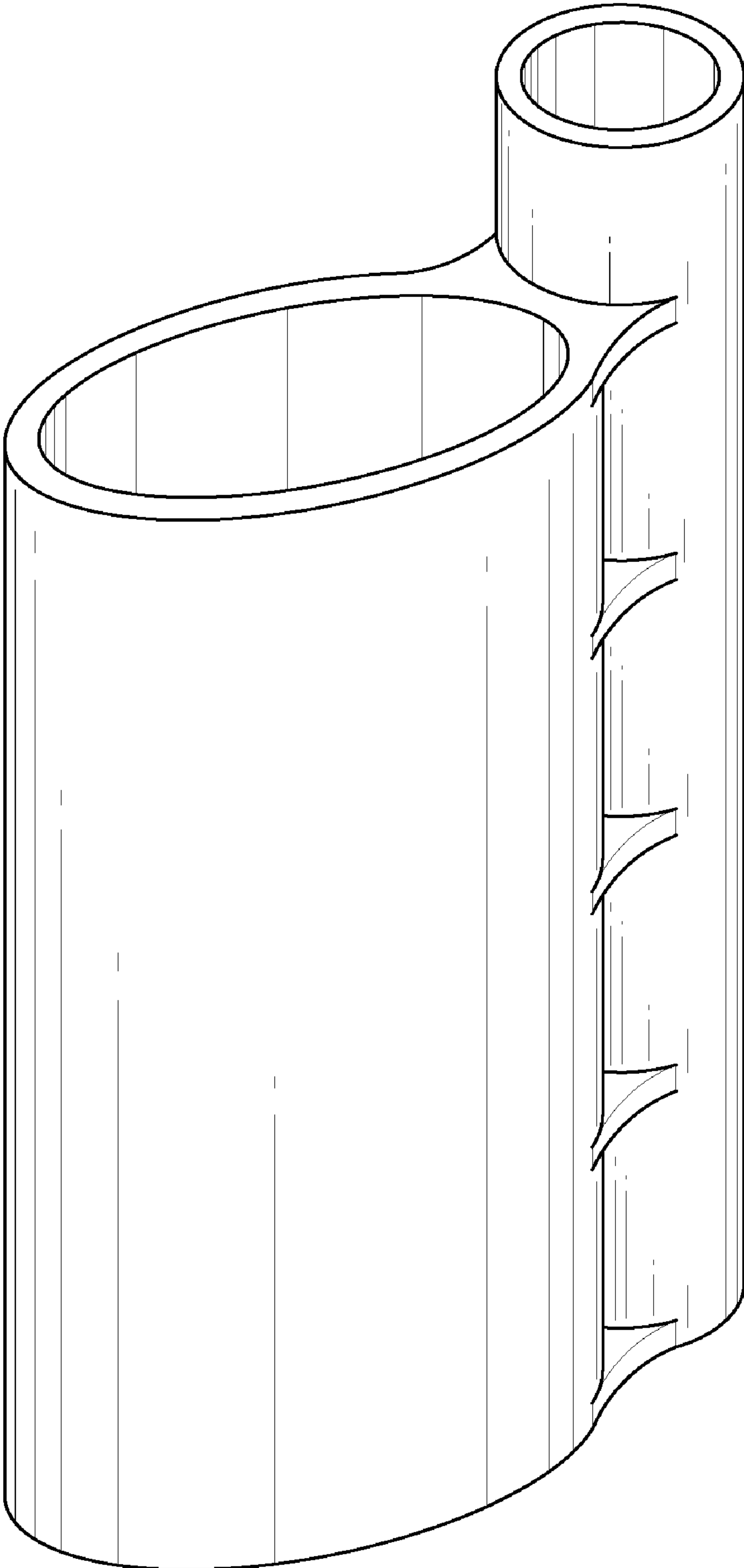

FIG. 1

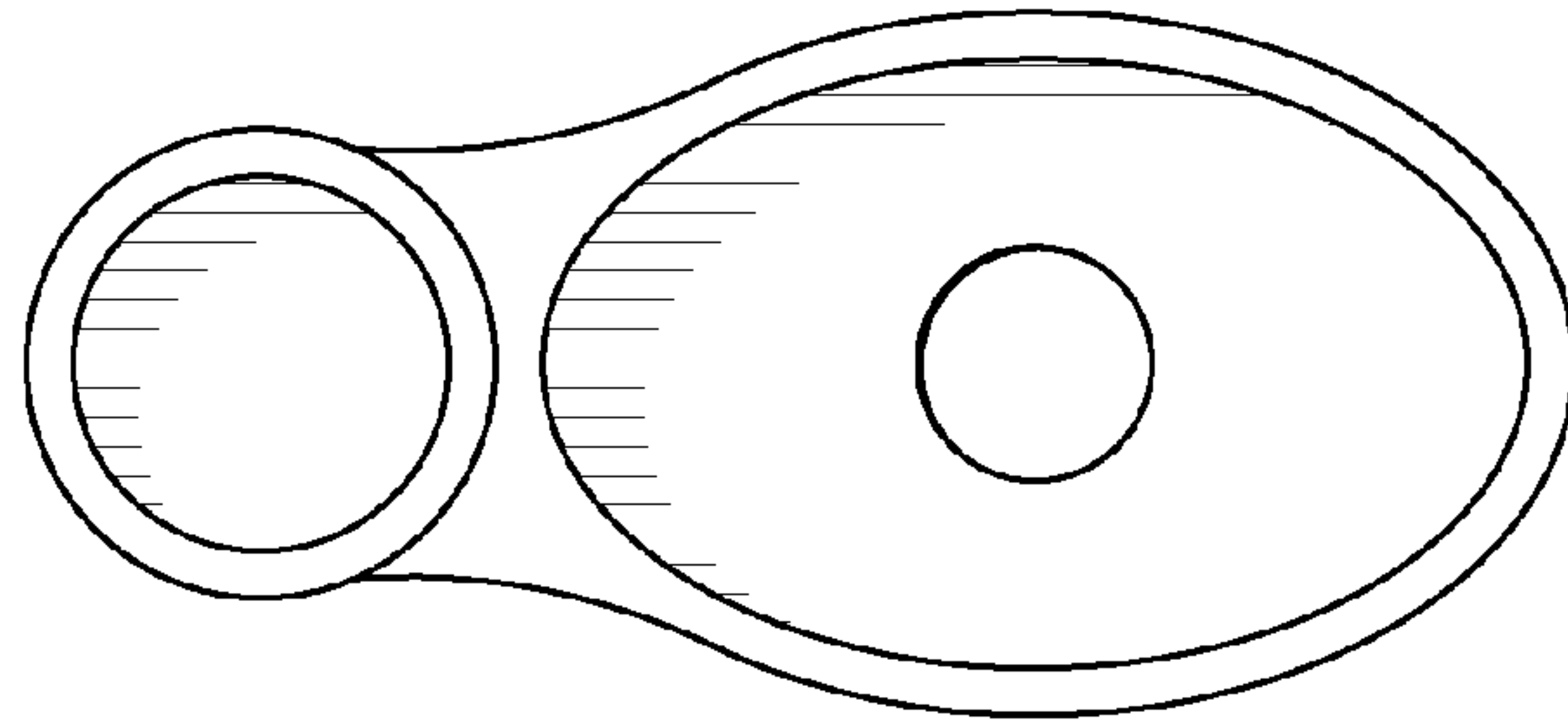

FIG. 2

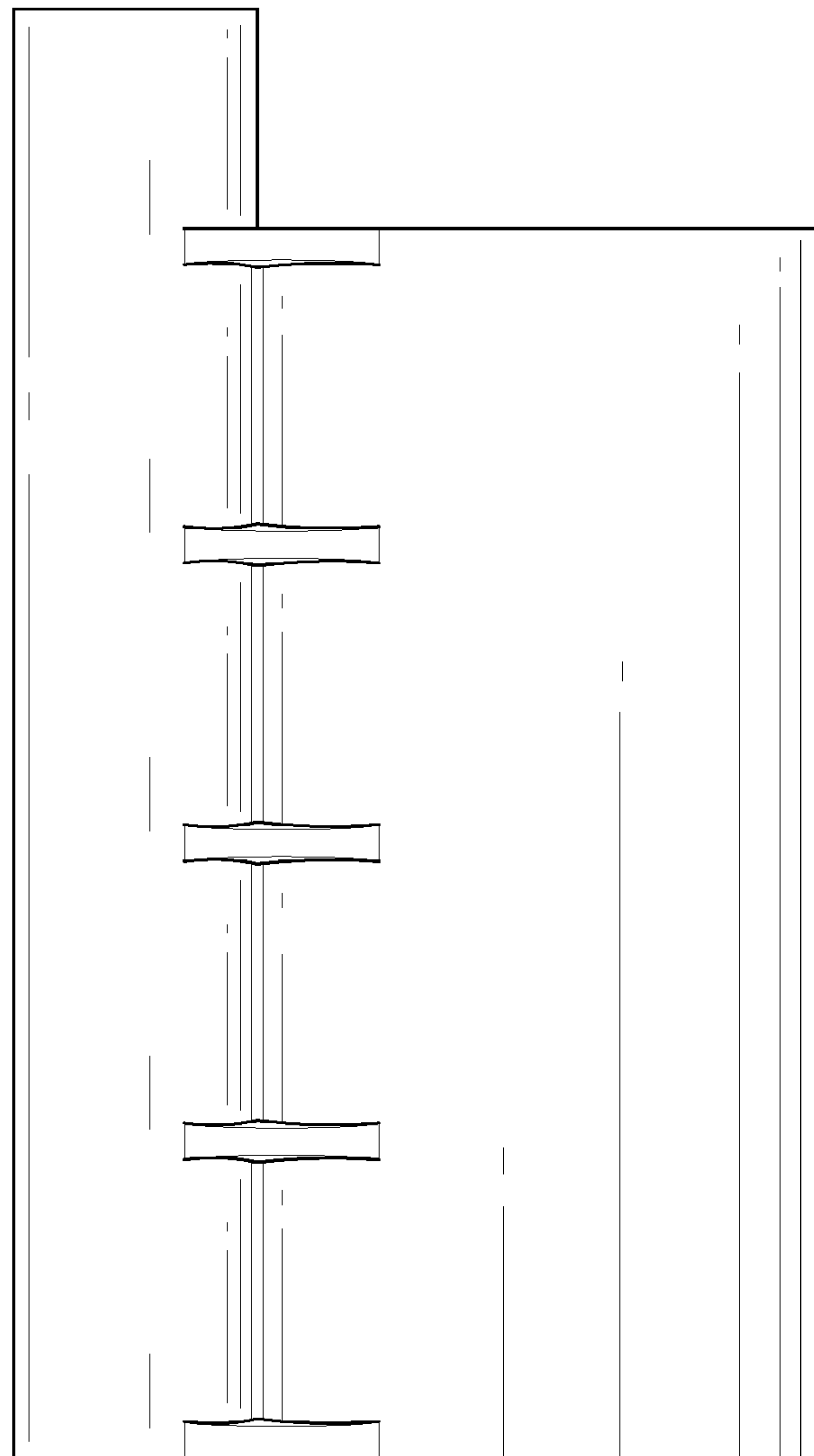

FIG. 3

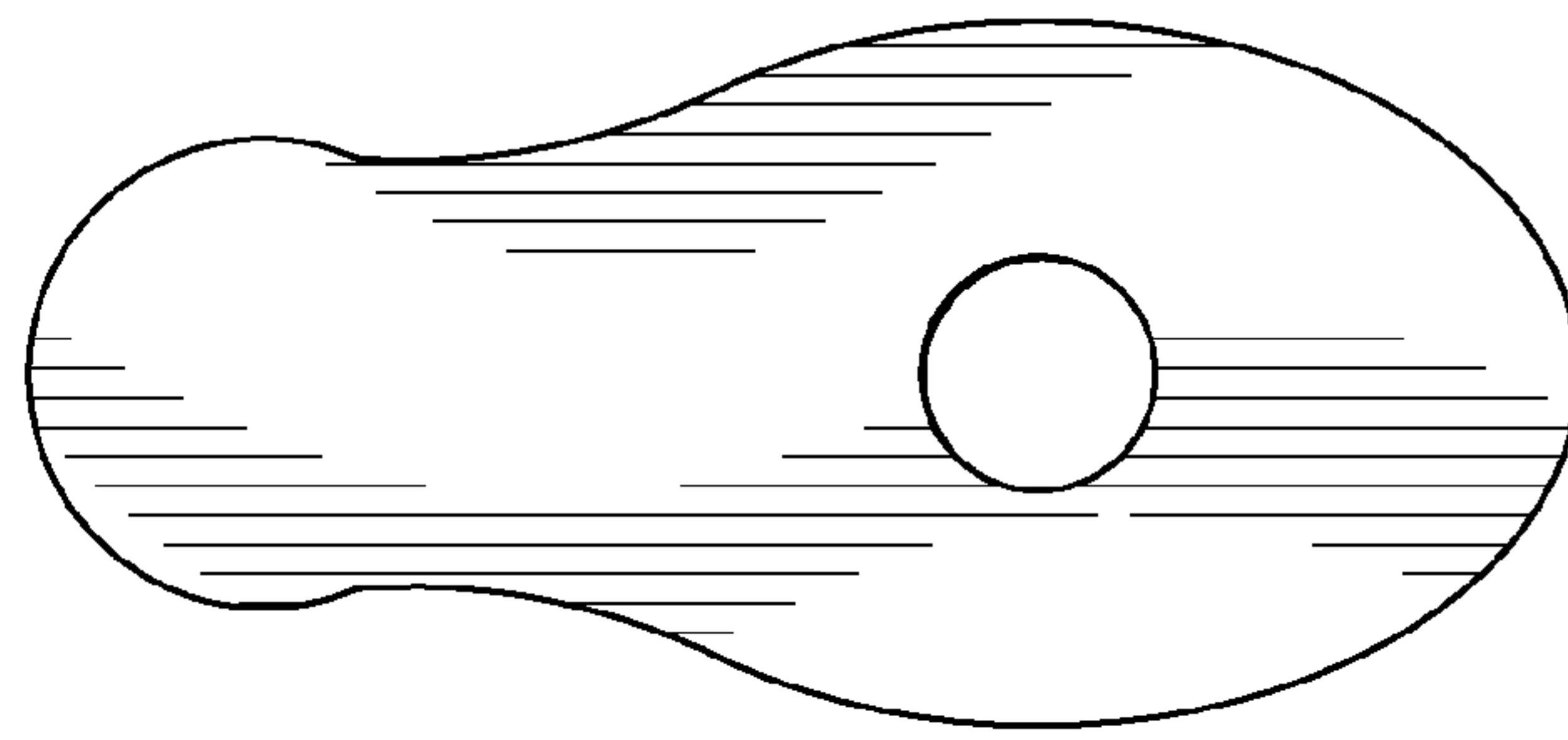

FIG. 4

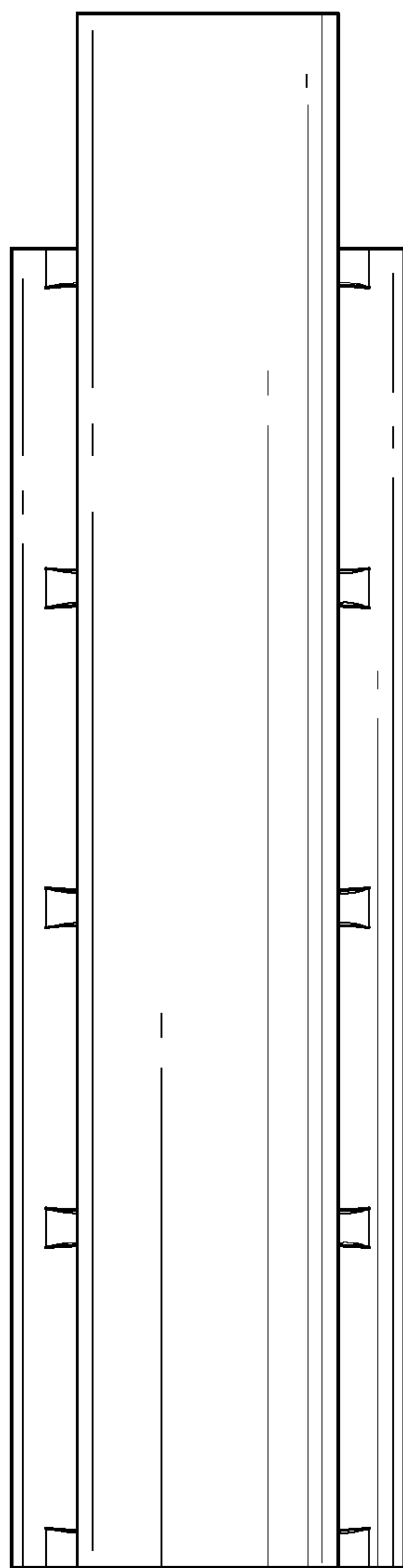

FIG. 5

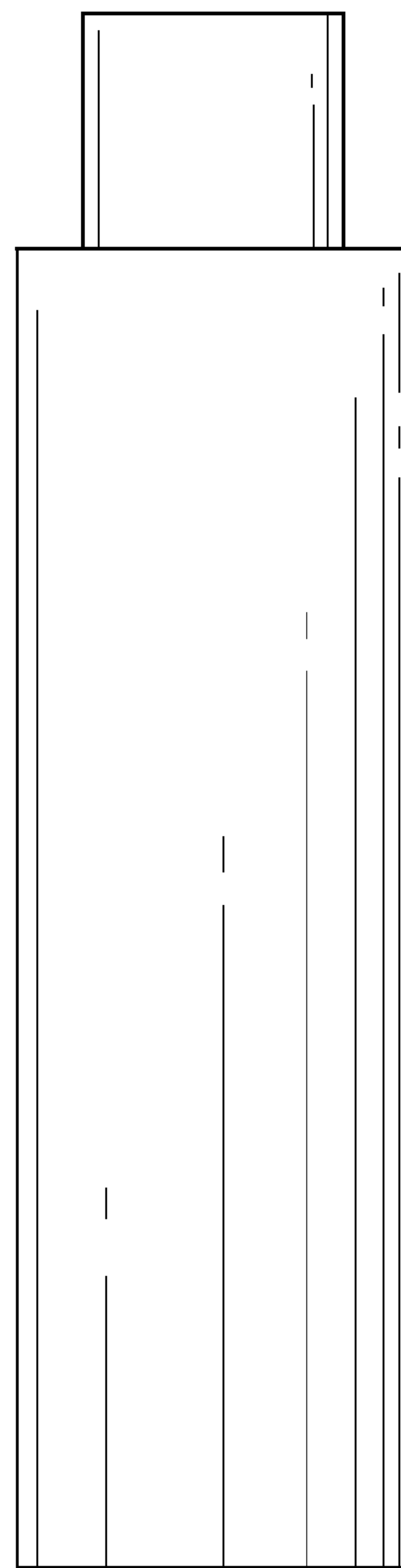

FIG. 6

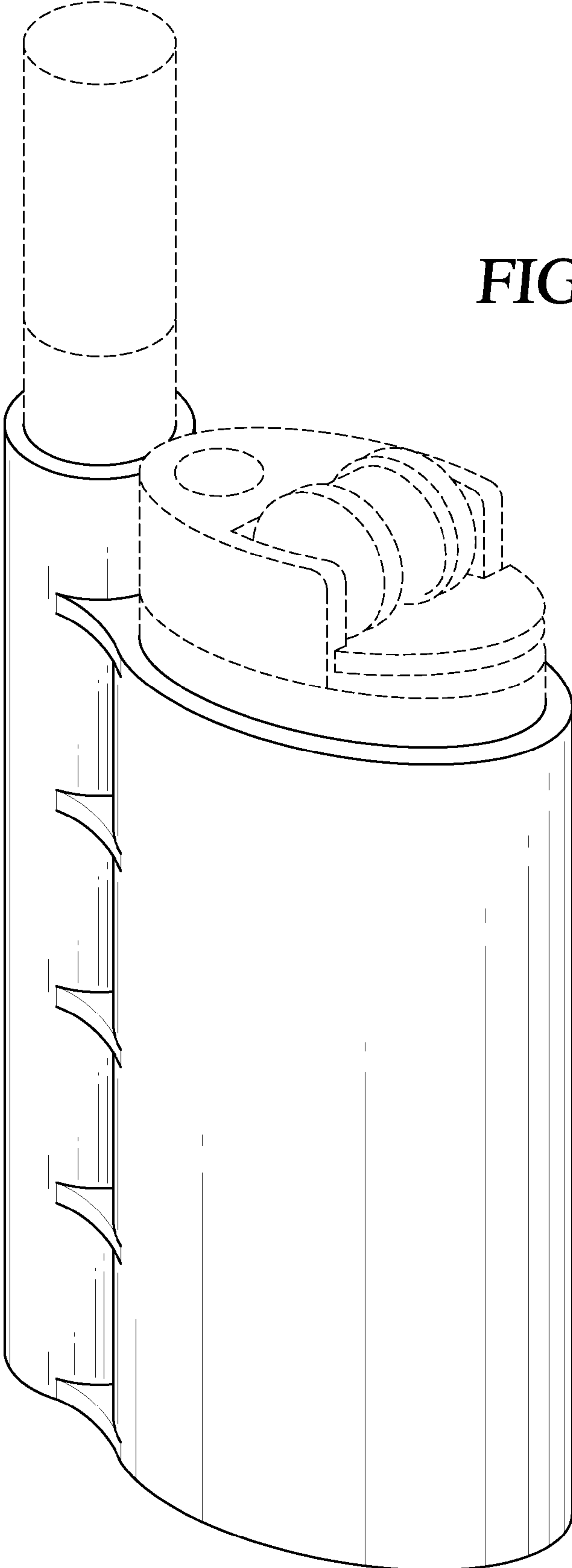

FIG. 7

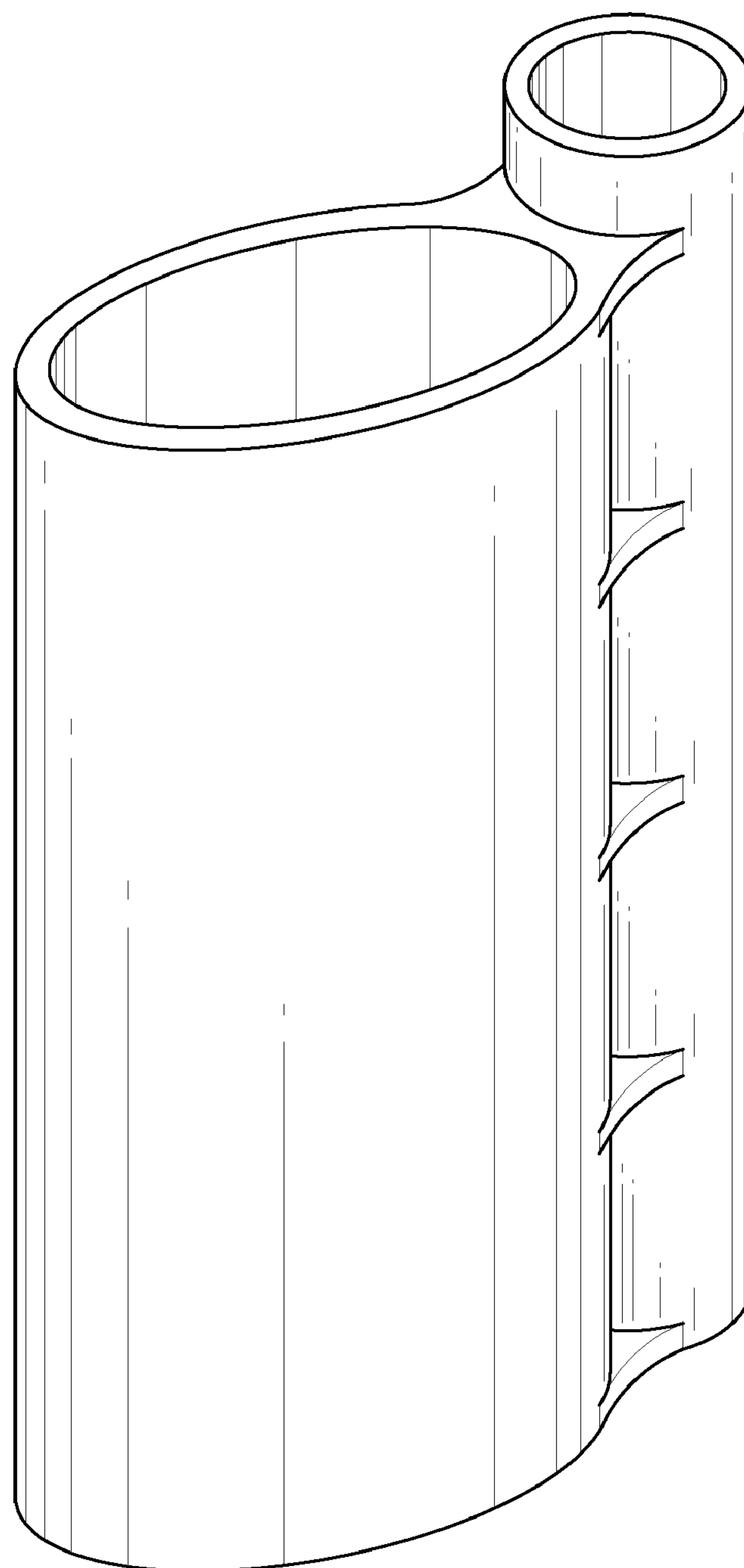

FIG. 8

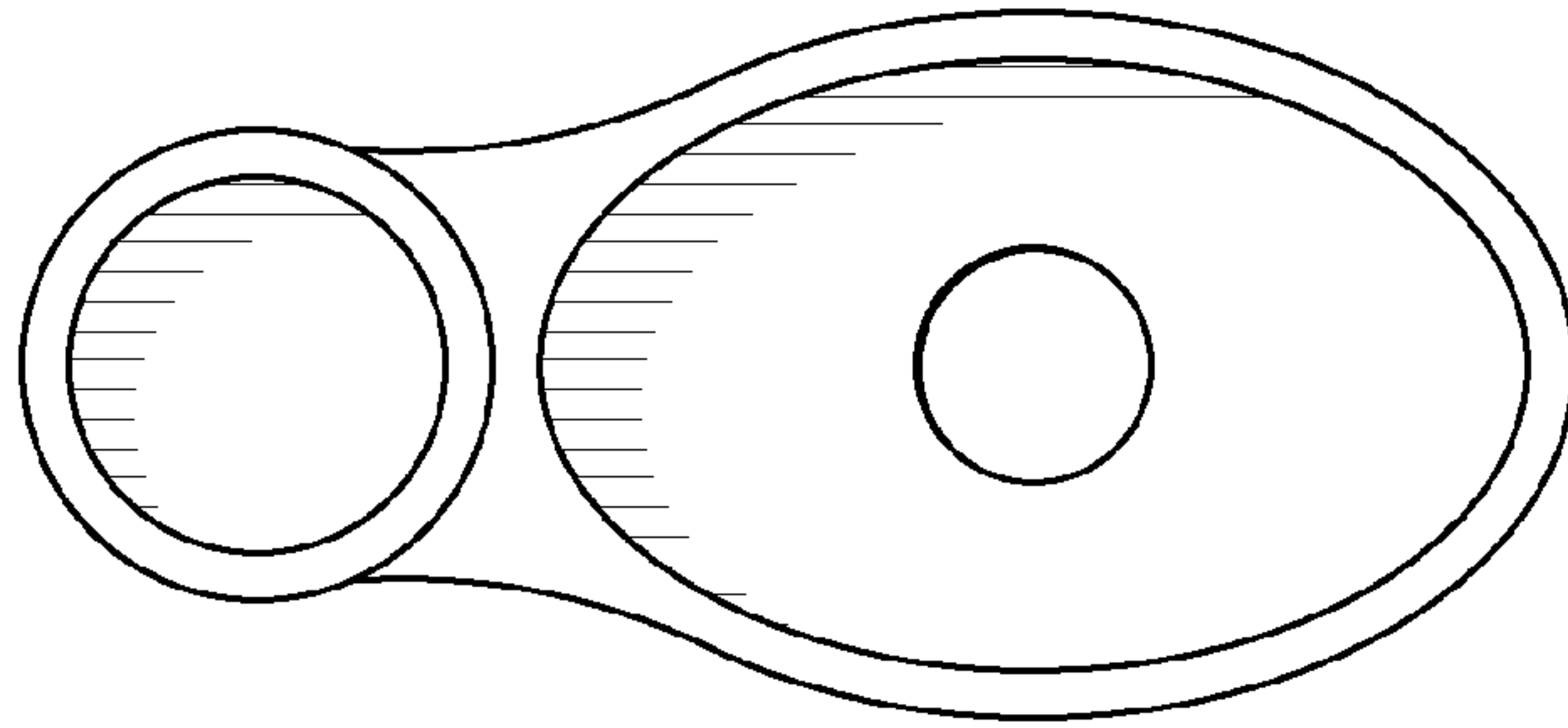

FIG. 9

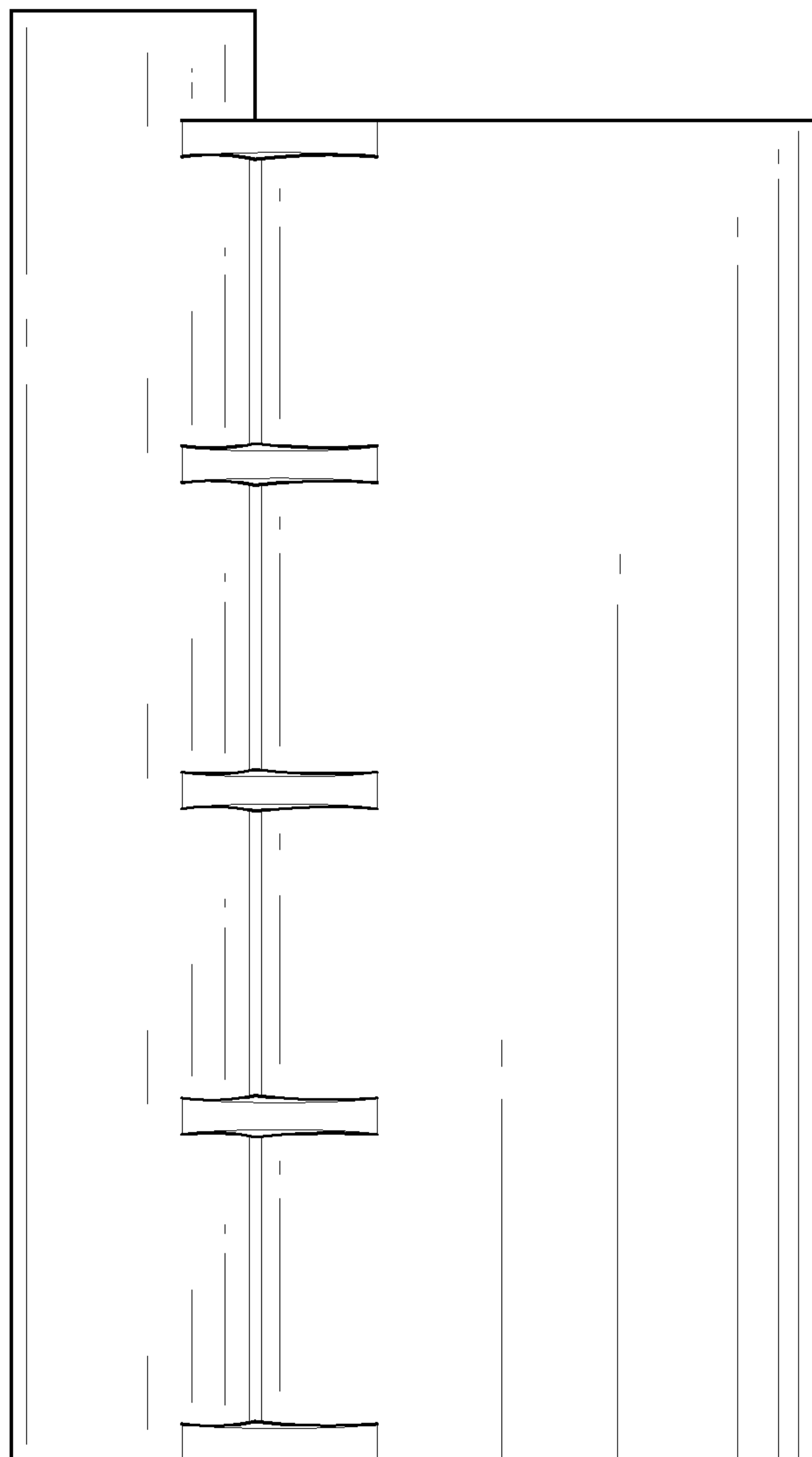

FIG. 10

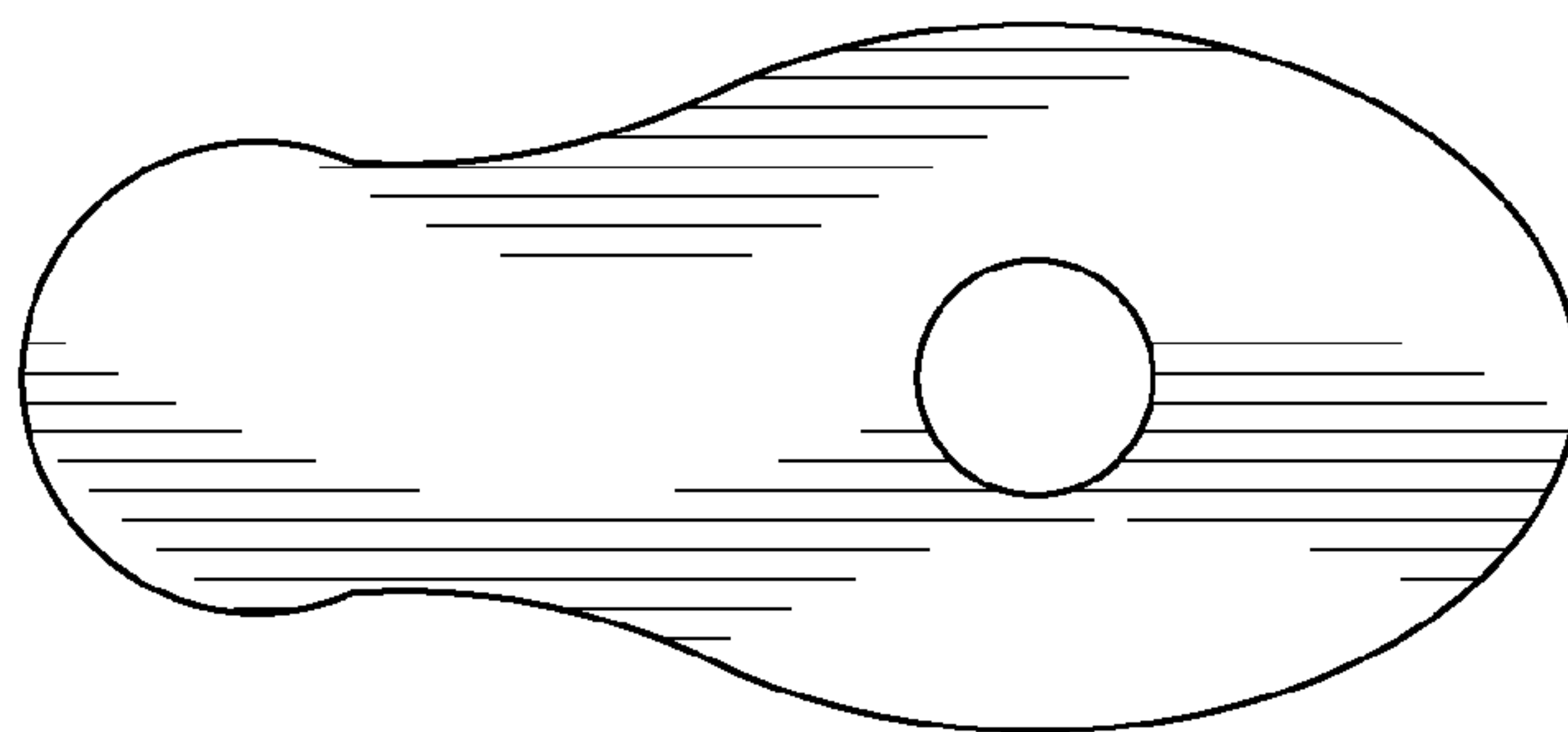

FIG. 11

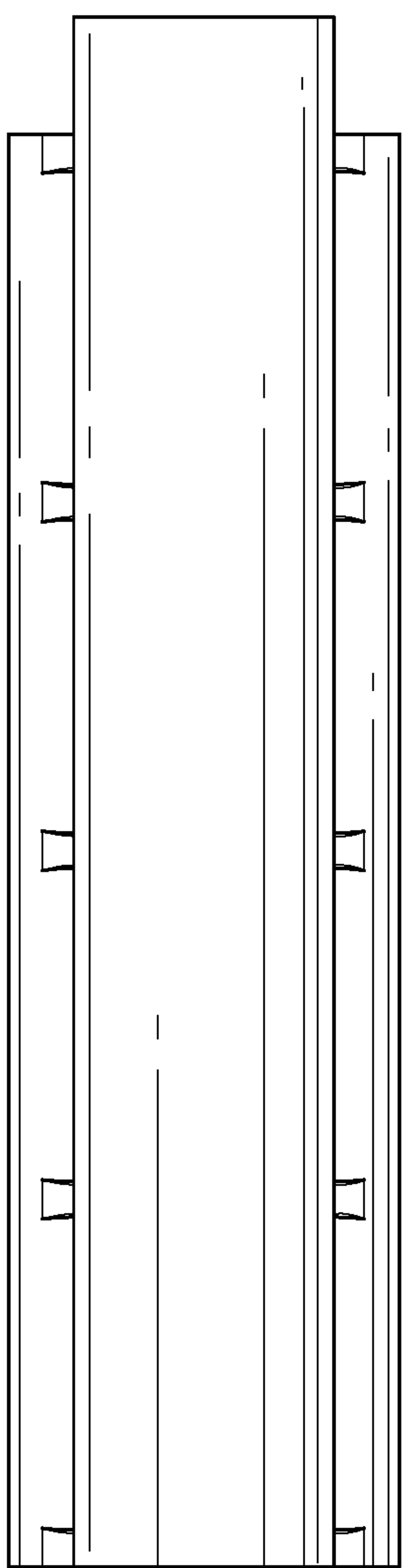

FIG. 12

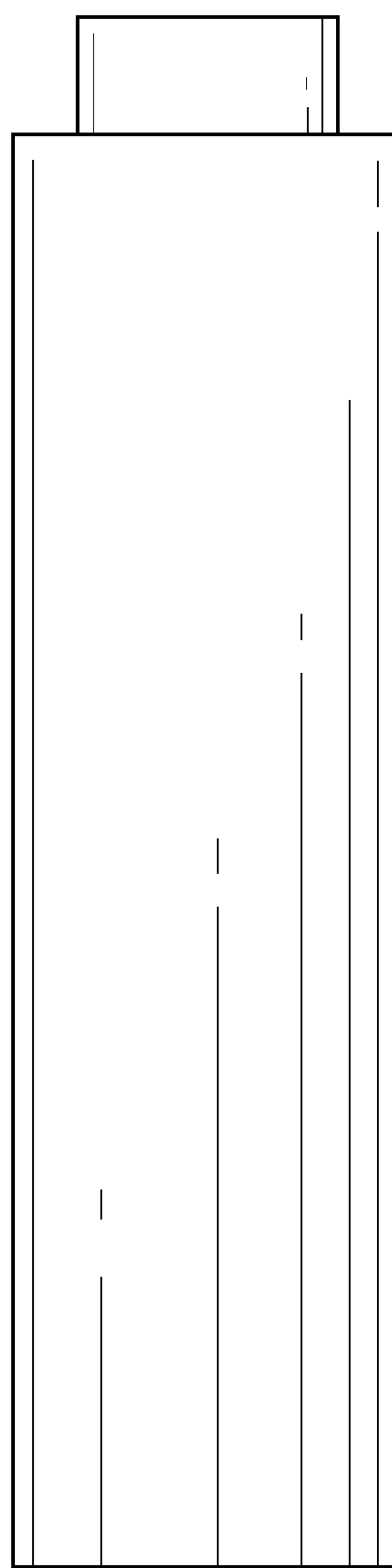

FIG. 13

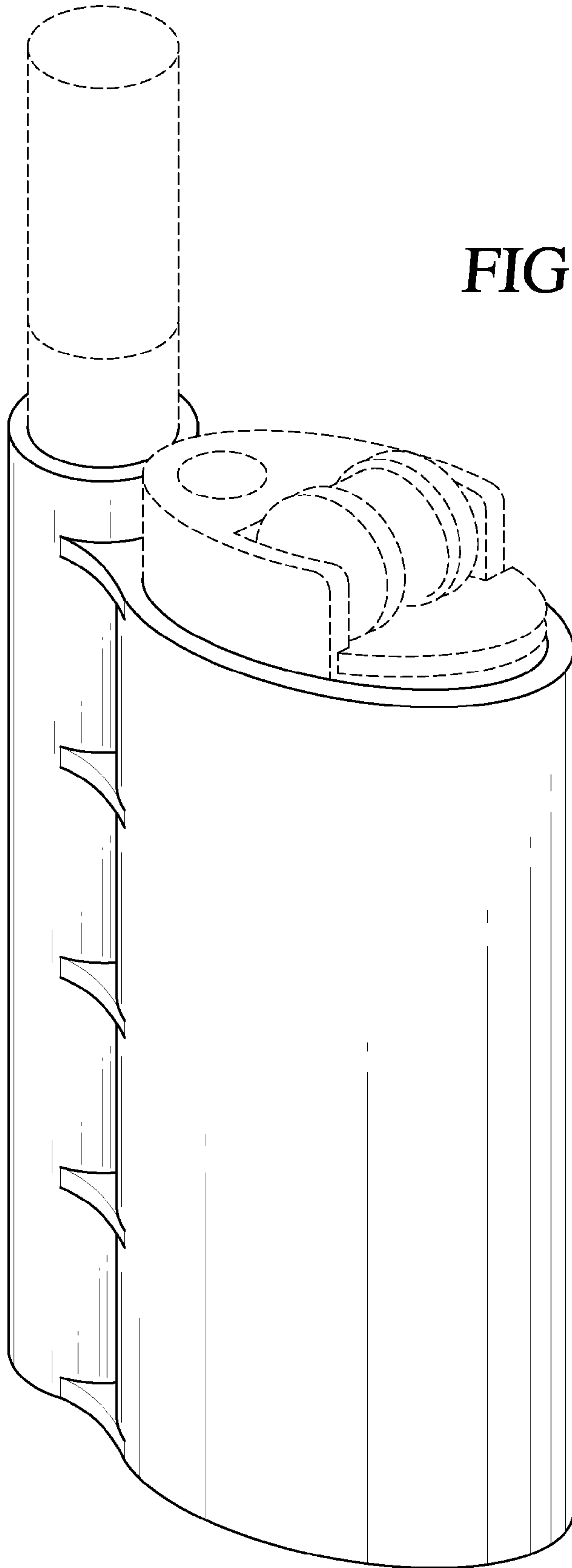

FIG. 14