



US00D635947S

(12) **United States Design Patent**
Park et al.

(10) **Patent No.:** **US D635,947 S**

(45) **Date of Patent:** **** *Apr. 12, 2011**

(54) **MOBILE PHONE**

(75) Inventors: **Jei-Sung Park**, Suwon-si (KR);
Yoon-Young Cho, Seoul (KR);
Chang-Hwan Hwang, Goyang-si (KR)

(73) Assignee: **Samsung Electronics. Co., Ltd.**,
Suwon-Si (KR)

(*) Notice: This patent is subject to a terminal disclaimer.

(**) Term: **14 Years**

(21) Appl. No.: **29/343,614**

(22) Filed: **Sep. 16, 2009**

(30) **Foreign Application Priority Data**

Jul. 21, 2009 (KR) 30-2009-0032219

(51) **LOC (9) Cl.** **14-03**

(52) **U.S. Cl.** **D14/138 AB**

(58) **Field of Classification Search** D14/138 AB,
D14/496, 341, 345, 346, 203.3, 203.4, 203.7;
455/575.3; D21/517; 379/433.13
See application file for complete search history.

(56) **References Cited**

U.S. PATENT DOCUMENTS

D508,035	S	*	8/2005	Kim et al.	D14/138 AB
D543,172	S	*	5/2007	Lee et al.	D14/138 AB
7,269,443	B2	*	9/2007	Park et al.	455/556.2
D560,643	S	*	1/2008	Kim et al.	D14/138 AB
D566,673	S	*	4/2008	Lee	D14/138 AB
D568,863	S	*	5/2008	Lee et al.	D14/138 AB
D570,817	S	*	6/2008	Han et al.	D14/138 AB
D571,345	S	*	6/2008	Kim et al.	D14/138 AB
D572,226	S	*	7/2008	Park et al.	D14/138 AB
D573,125	S	*	7/2008	Lee	D14/138 AB
D573,574	S	*	7/2008	Suk et al.	D14/138 AB
D573,968	S	*	7/2008	Chen et al.	D14/138 AB
D578,980	S	*	10/2008	Minamide et al.	D14/138 AB
D578,981	S	*	10/2008	Park et al.	D14/138 AB
D582,877	S	*	12/2008	Lee et al.	D14/138 AB
D583,794	S	*	12/2008	Lee et al.	D14/138 AB

D589,927	S	*	4/2009	Millora et al.	D14/138 AB
D599,765	S	*	9/2009	Park et al.	D14/138 AB
D601,997	S	*	10/2009	Kim et al.	D14/138 AB
D603,828	S	*	11/2009	Park et al.	D14/138 AB
D607,857	S	*	1/2010	Kim et al.	D14/138 AB
D614,598	S	*	4/2010	Lee et al.	D14/138 AB
D615,057	S	*	5/2010	Kim et al.	D14/138 AB
2009/0247246	A1	*	10/2009	Takita et al.	455/575.3

OTHER PUBLICATIONS

Samsung S3600 telephone, announced Oct. 2008, [online], [site visited Aug. 10, 2010]. Available from Internet ,<URL: http://www.gsmarena.com>.*

LG KP210 telephone, announced Feb. 2008, [online], [site visited Aug. 10, 2010]. Available from Internet ,<URL: http://www.gsmarena.com>.*

Samsung G400 Soul telephone, announced Mar. 2008, [online], [site visited Aug. 10, 2010]. Available from Internet ,<URL: http://www.gsmarena.com>.*

Sagem my850c telephone, announced Mar. 2006, [online], [site visited Aug. 10, 2010]. Available from Internet ,<URL: http://www.gsmarena.com>.*

LG KP235 telephone, announced Feb. 2008, [online], [site visited Aug. 10, 2010]. Available from Internet ,<URL: http://www.gsmarena.com>.*

* cited by examiner

Primary Examiner — Jeffrey D Asch

(74) *Attorney, Agent, or Firm* — Staas & Halsey LLP

(57) **CLAIM**

The ornamental design for a mobile phone, as shown and described.

DESCRIPTION

FIG. 1 is a front perspective view of a mobile phone; FIG. 2 is a front view of the mobile phone of FIG. 1; FIG. 3 is a rear view of the mobile phone of FIG. 1; FIG. 4 is a left-side view of the mobile phone of FIG. 1; FIG. 5 is a right-side view of the mobile phone of FIG. 1; FIG. 6 is a top plan view of the mobile phone of FIG. 1; FIG. 7 is a bottom plan view of the mobile phone of FIG. 1; and, FIG. 8 is a front perspective open view of the mobile phone of FIG. 1.

1 Claim, 5 Drawing Sheets

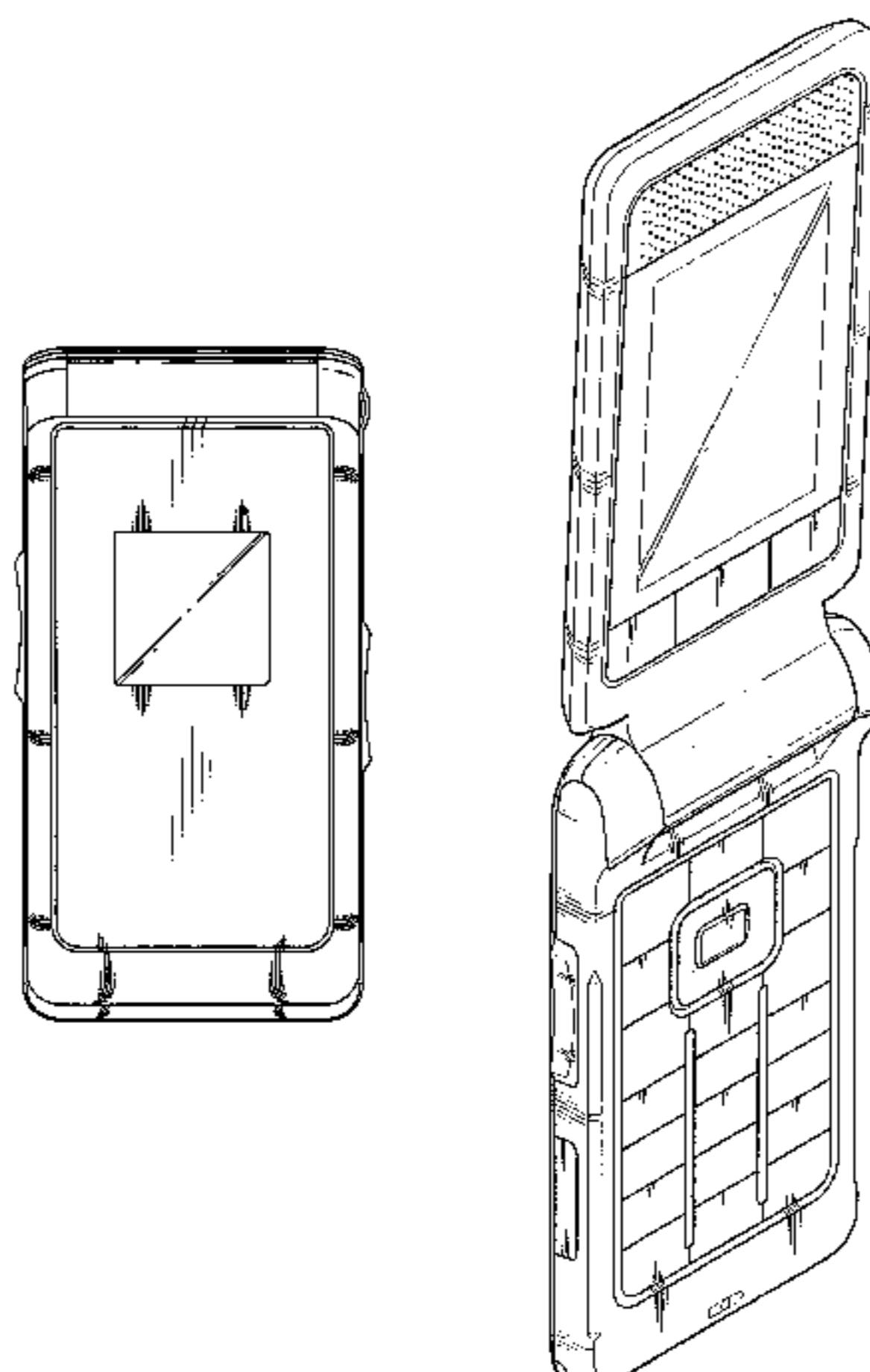

FIG. 1

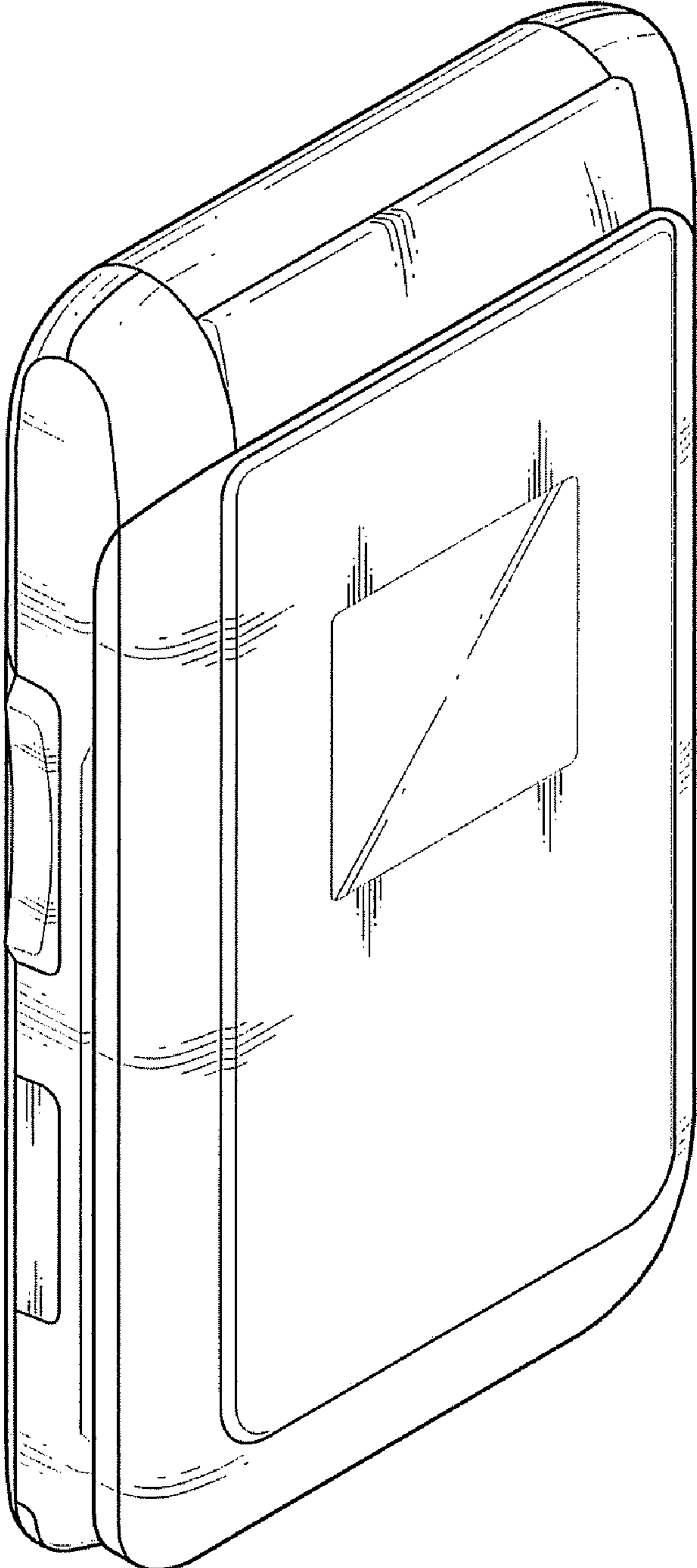

FIG. 2

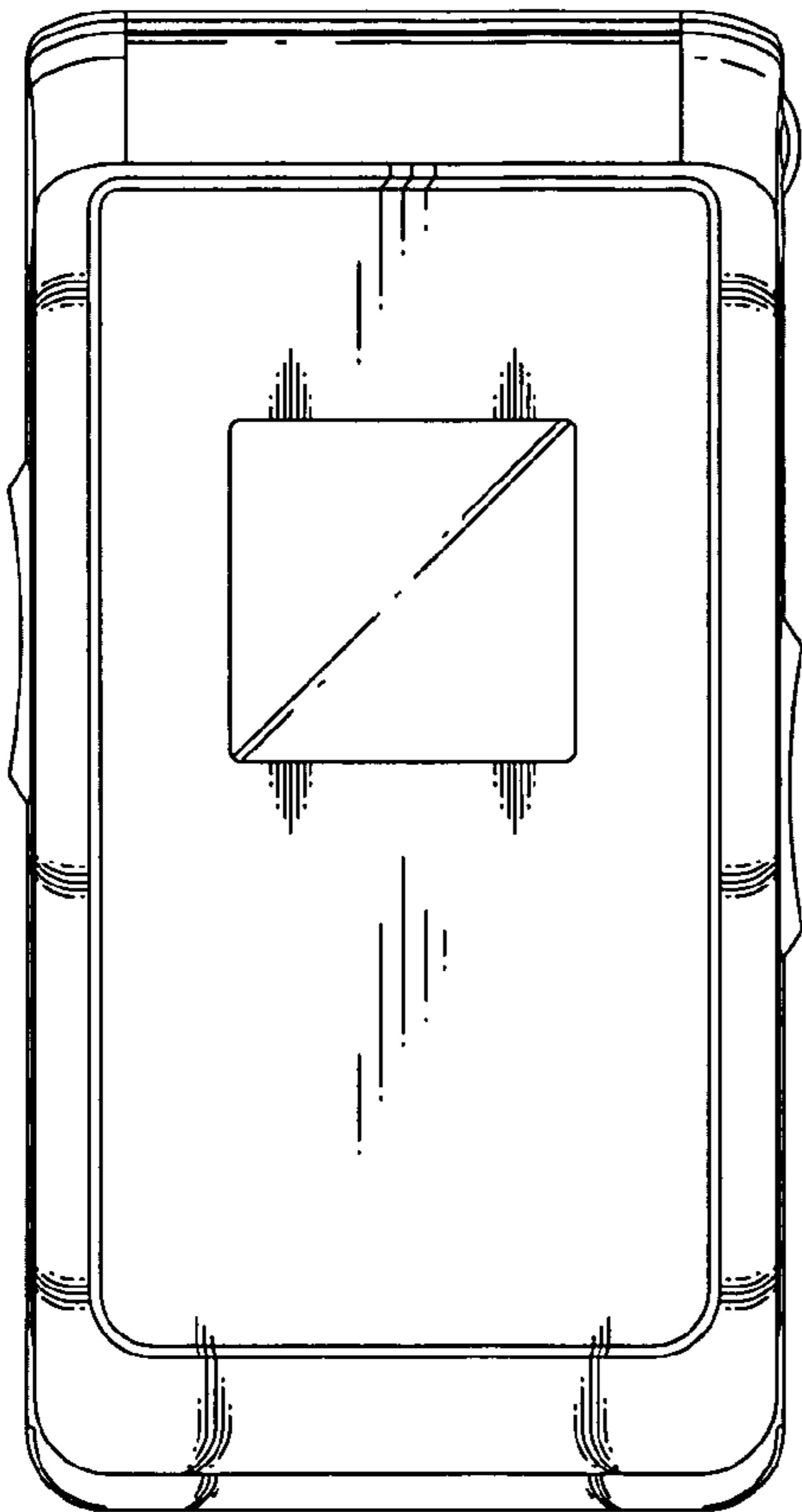

FIG. 3

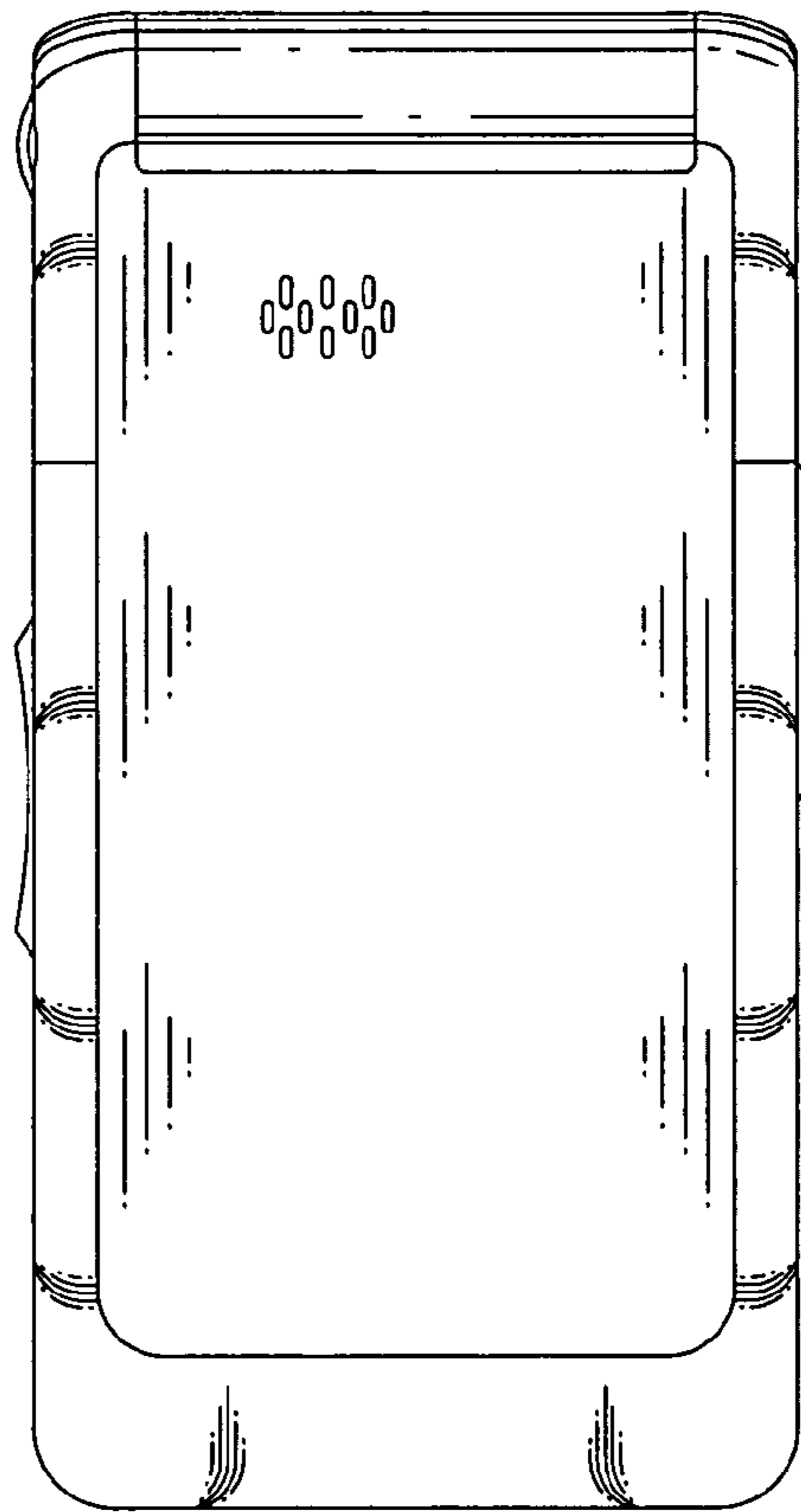

FIG. 4

FIG. 5

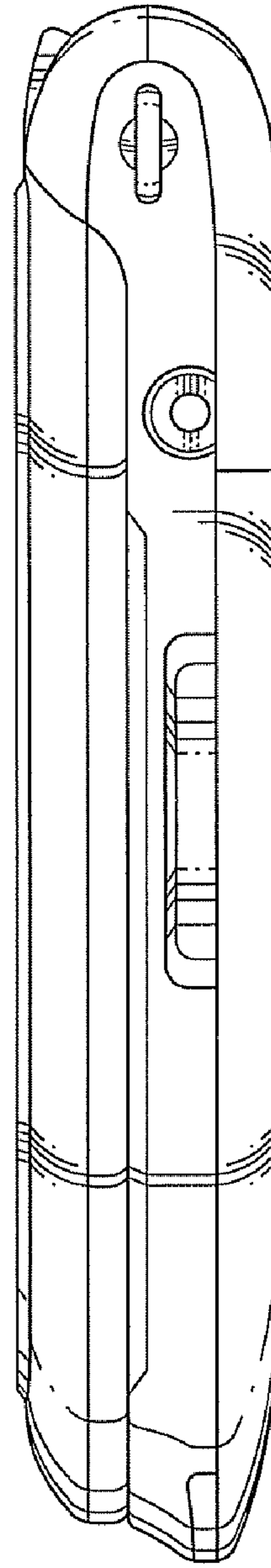
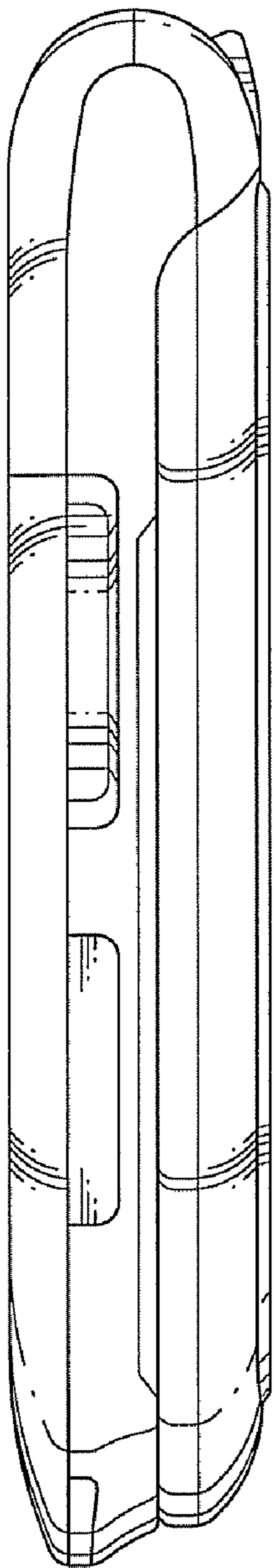

FIG. 6

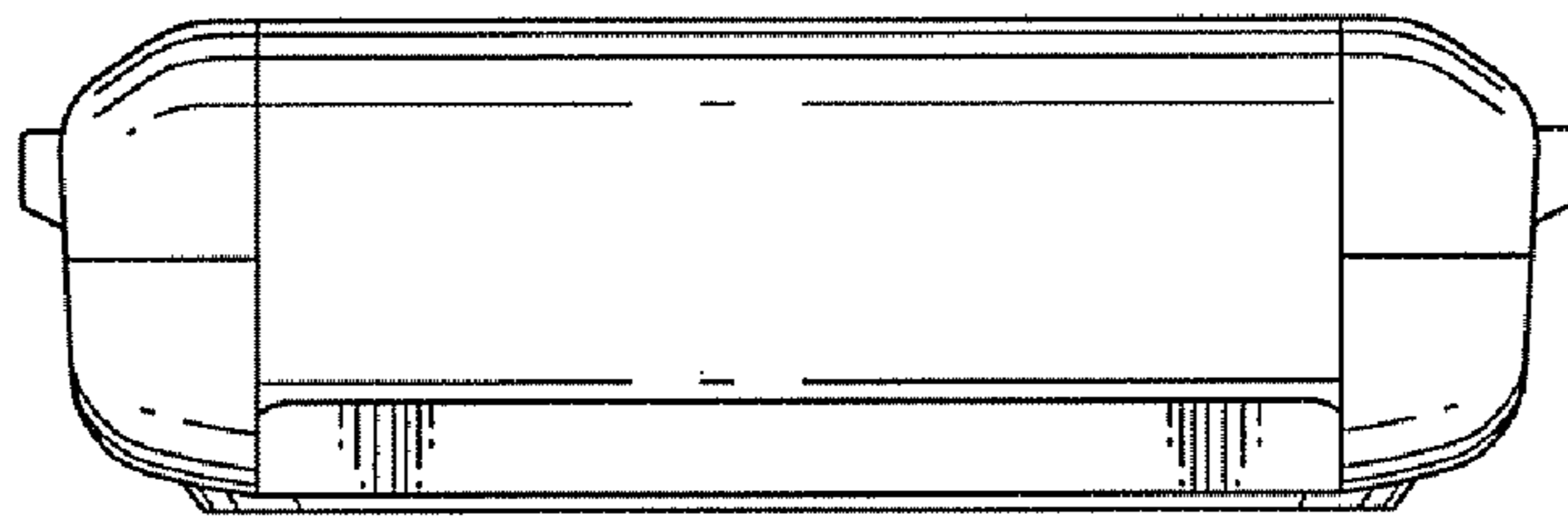

FIG. 7

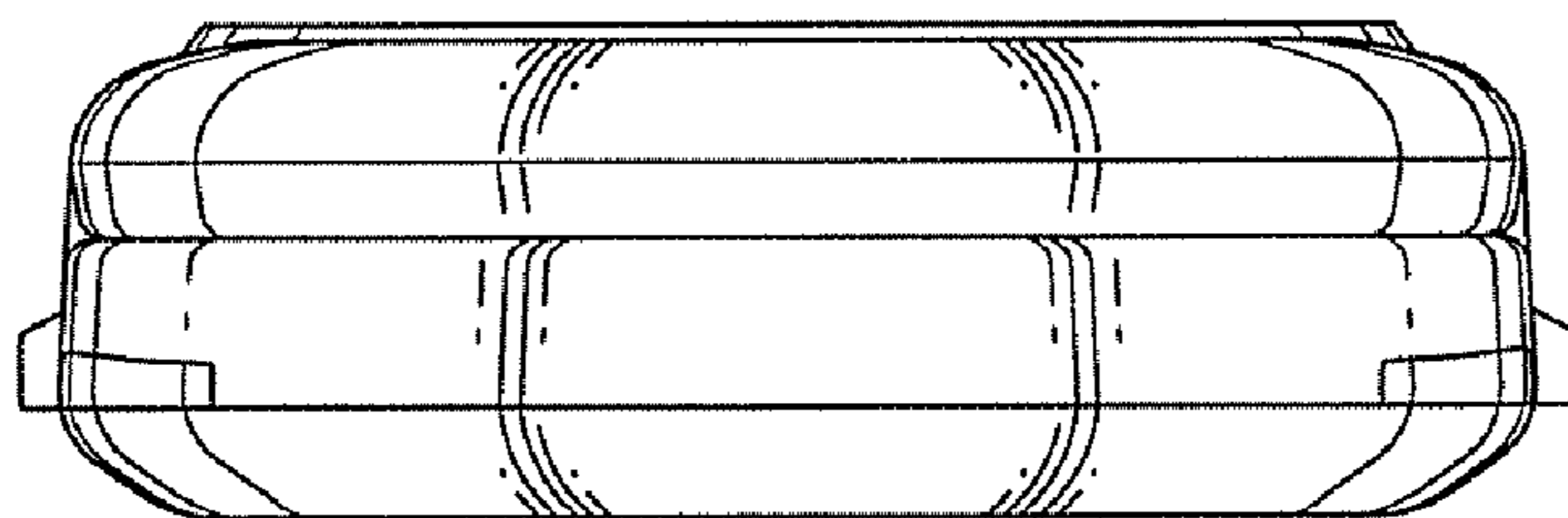

FIG. 8

