

US00D635946S

(12) **United States Design Patent**  
**Garra et al.**

(10) **Patent No.:** **US D635,946 S**

(45) **Date of Patent:** **\*\* Apr. 12, 2011**

(54) **COMMUNICATION DEVICE**

(75) Inventors: **LanTing L. Garra**, Sunrise, FL (US);  
**Craig F Siddoway**, Davie, FL (US)

(73) Assignee: **Motorola Solutions, Inc.**, Schaumburg,  
IL (US)

(\*\*) Term: **14 Years**

(21) Appl. No.: **29/366,777**

(22) Filed: **Jul. 29, 2010**

(51) **LOC (9) Cl.** ..... **14-03**

(52) **U.S. Cl.** ..... **D14/137**

(58) **Field of Classification Search** ..... D14/135,  
D14/137, 139, 157, 188, 197-198, 257, 258,  
D14/138 R, 138 AA, 138 C, 138, 138 AD,  
D14/138 AC, 138 G, 147, 218, 341-347;  
361/814; 455/90.1-90.3

See application file for complete search history.

(56) **References Cited**

**U.S. PATENT DOCUMENTS**

6,041,243	A *	3/2000	Davidson et al.	.....	455/575.1
D430,126	S *	8/2000	Lee	.....	D14/137
D433,001	S *	10/2000	Haase et al.	.....	D14/137
D433,395	S *	11/2000	Wong	.....	D14/137
D433,396	S *	11/2000	Wong	.....	D14/137
D451,484	S *	12/2001	Page et al.	.....	D14/137
D455,411	S *	4/2002	Wong	.....	D14/137
6,473,631	B1 *	10/2002	Siddoway et al.	.....	455/575.1
D467,888	S *	12/2002	Mirabelli et al.	.....	D14/137
D481,025	S *	10/2003	Cebe et al.	.....	D14/137
D482,009	S *	11/2003	Robertson et al.	.....	D14/137
D489,704	S *	5/2004	Kim	.....	D14/188

D493,155	S *	7/2004	Robertson et al.	.....	D14/137
D496,635	S *	9/2004	Lodato et al.	.....	D14/138 AA
D510,332	S *	10/2005	Haase et al.	.....	D14/137
6,973,291	B1 *	12/2005	Bellows	.....	455/90.3
D519,477	S *	4/2006	Liu et al.	.....	D14/137
D521,501	S *	5/2006	Miller et al.	.....	D14/218
D526,296	S *	8/2006	Wen	.....	D14/138 AA
D601,991	S *	10/2009	Tkachuk	.....	D14/138 AD
D602,893	S *	10/2009	Nishida	.....	D14/137

**OTHER PUBLICATIONS**

Vertex VXA-710 Spirit, [online], [retrieved on Jun. 26, 2010].  
Retrieved from Internet ,<URL: <http://www.twowayradioonline.com>>.\*

\* cited by examiner

*Primary Examiner* — Jeffrey D Asch

*Assistant Examiner* — Bridget L Eland

(74) *Attorney, Agent, or Firm* — Barbara R. Doutre

(57) **CLAIM**

The ornamental design for a communication device, as shown  
and described.

**DESCRIPTION**

FIG. 1 is a front perspective view of an ornamental design for  
a communication device;

FIG. 2 is a rear perspective view thereof;

FIG. 3 is a front view thereof;

FIG. 4 is a rear view thereof;

FIG. 5 is a first side view thereof;

FIG. 6 is a second side view thereof;

FIG. 7 is a top view thereof; and,

FIG. 8 is a bottom view thereof.

**1 Claim, 5 Drawing Sheets**

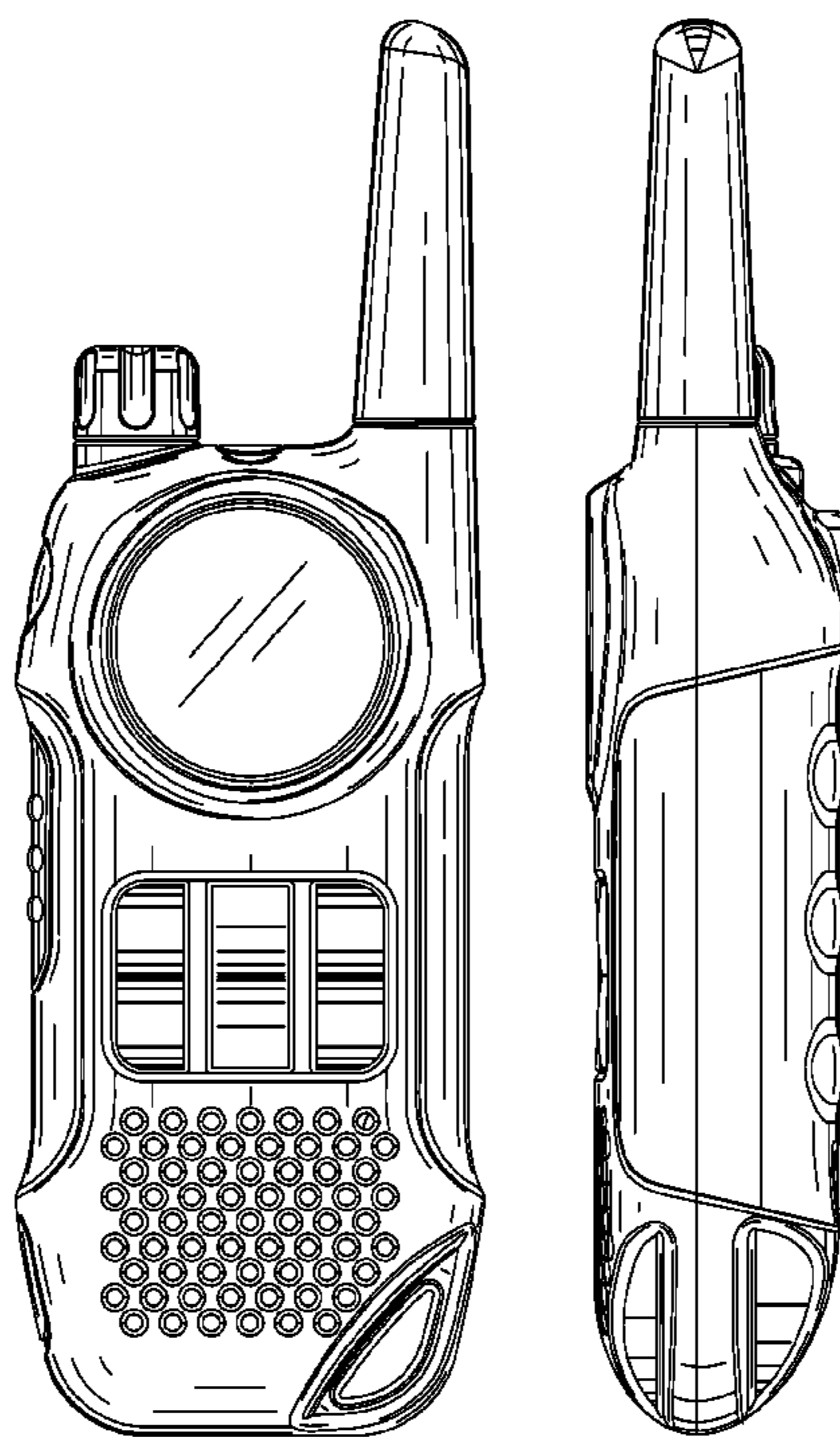

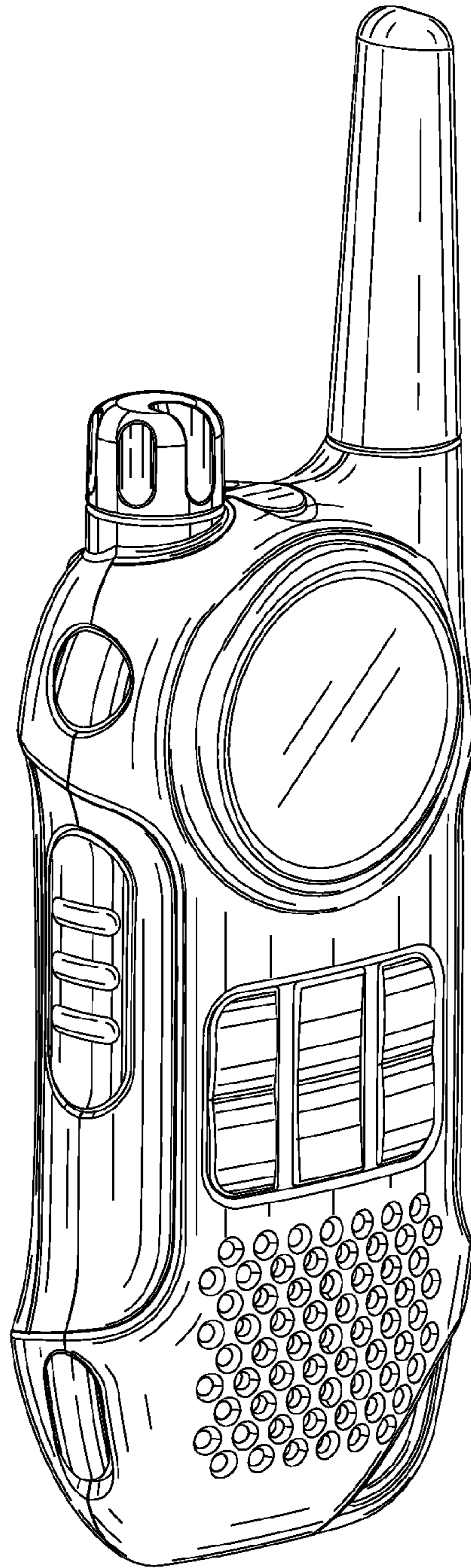

FIG. 1

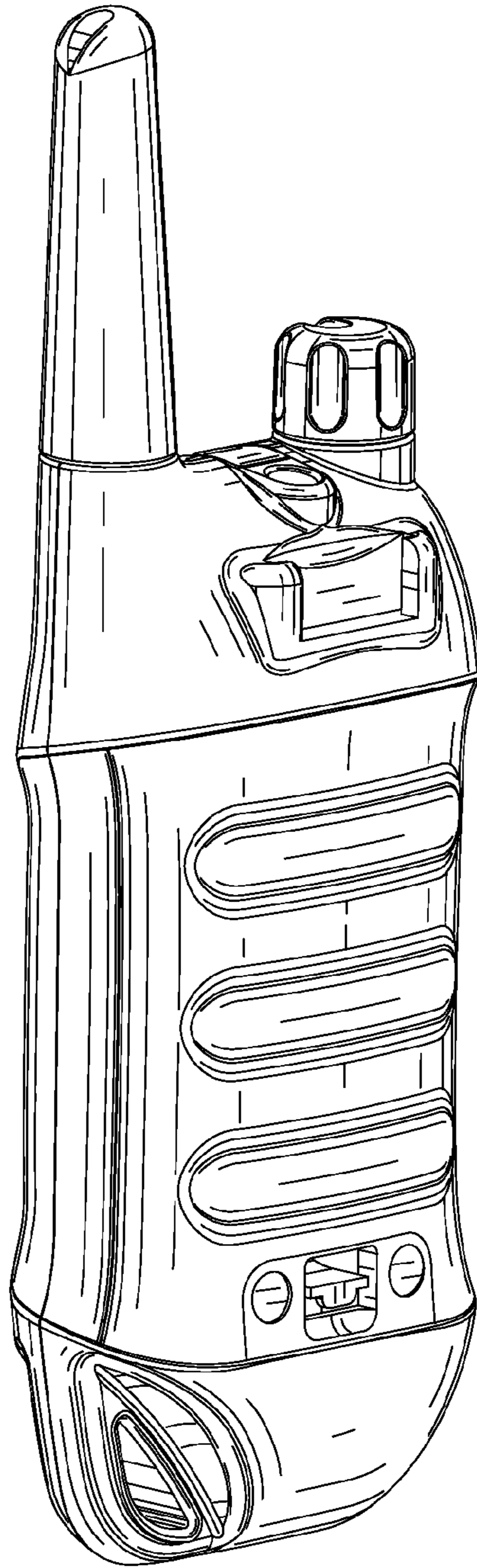

FIG. 2

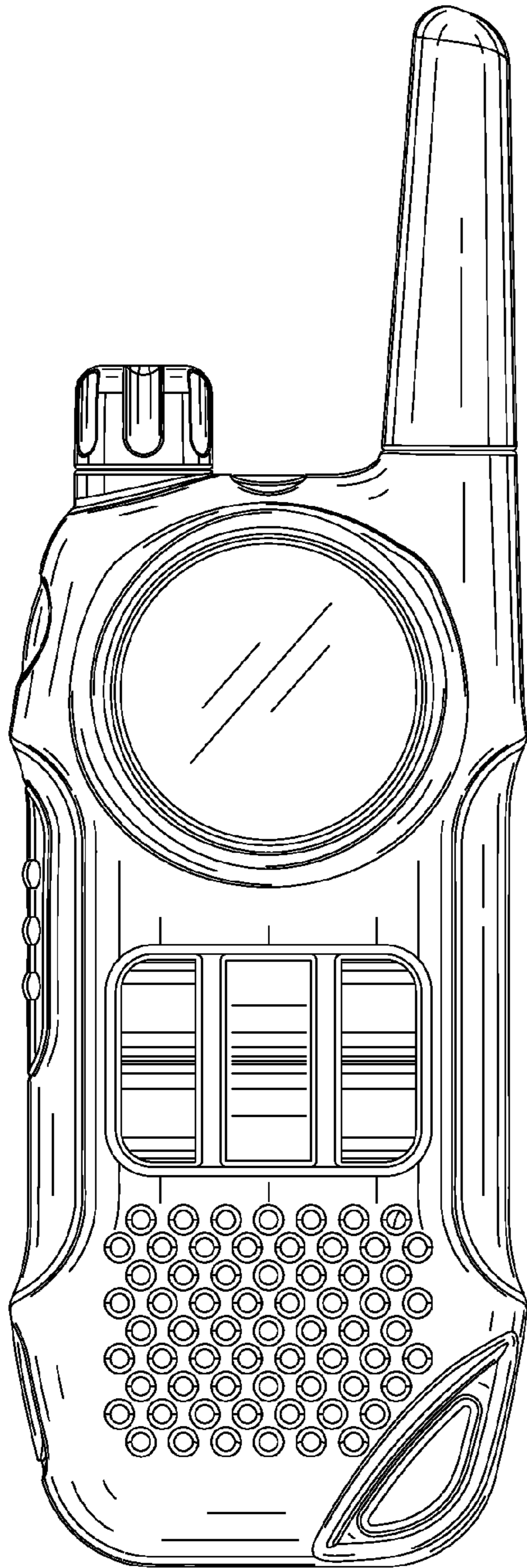

FIG. 3

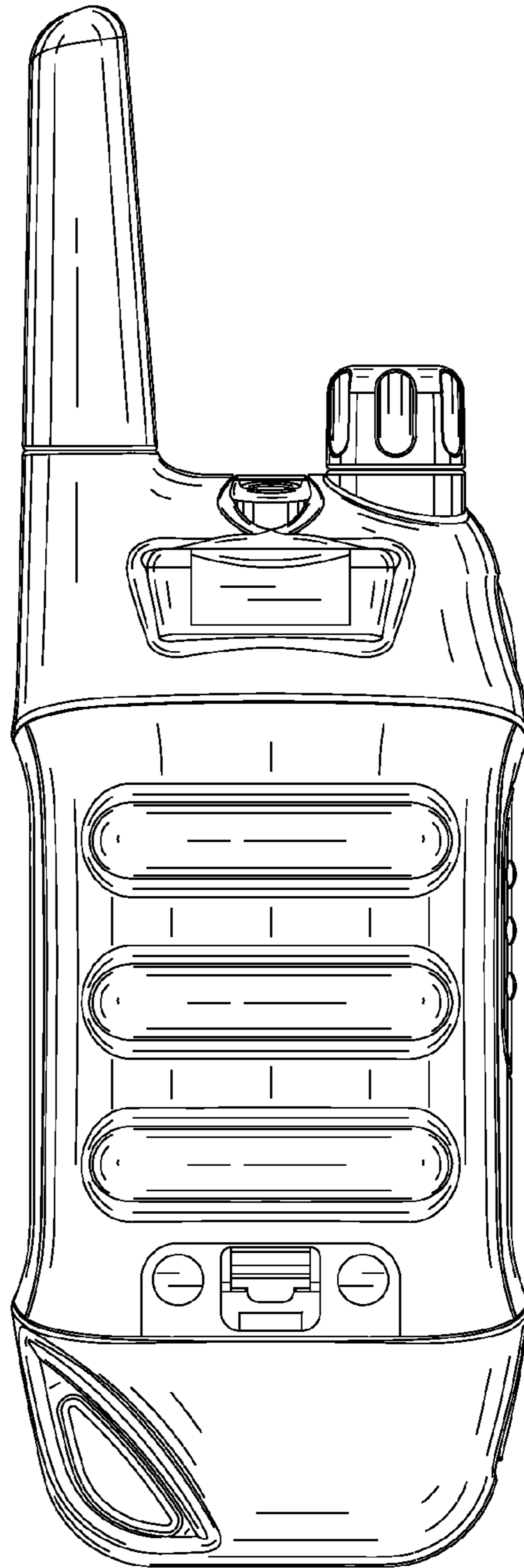

FIG. 4

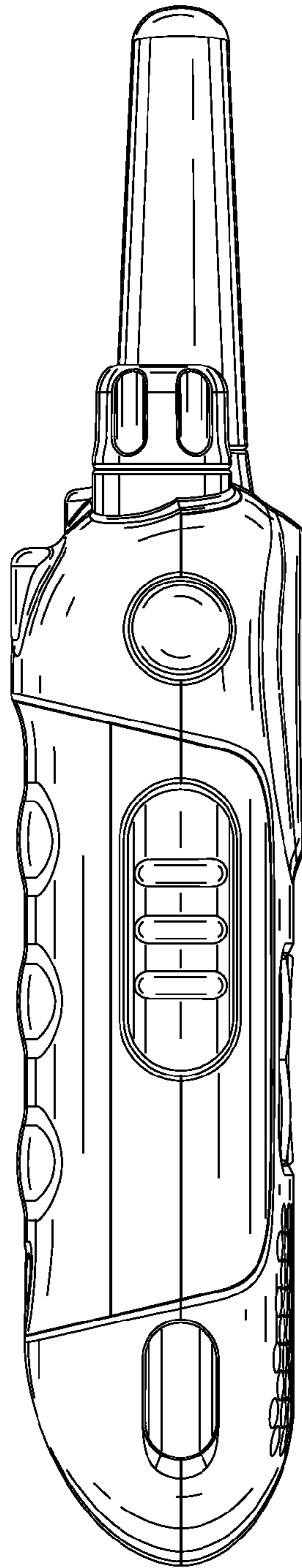

FIG. 5

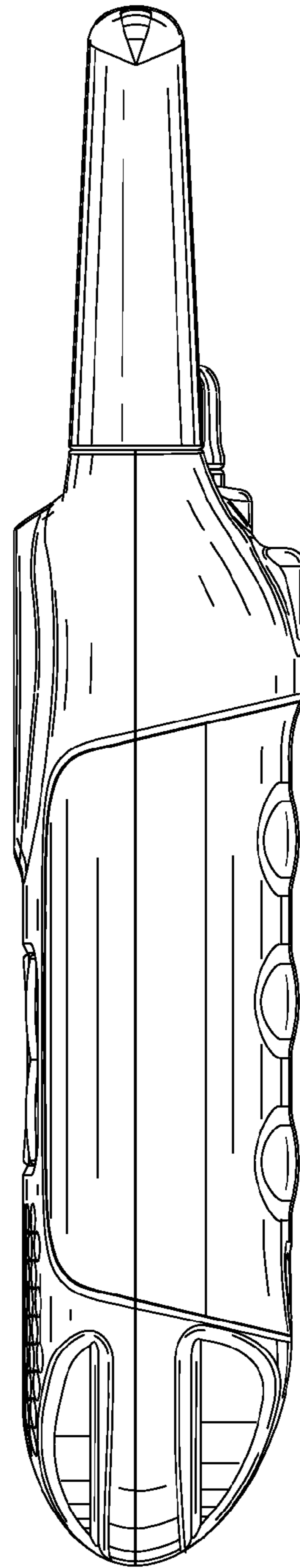

FIG. 6

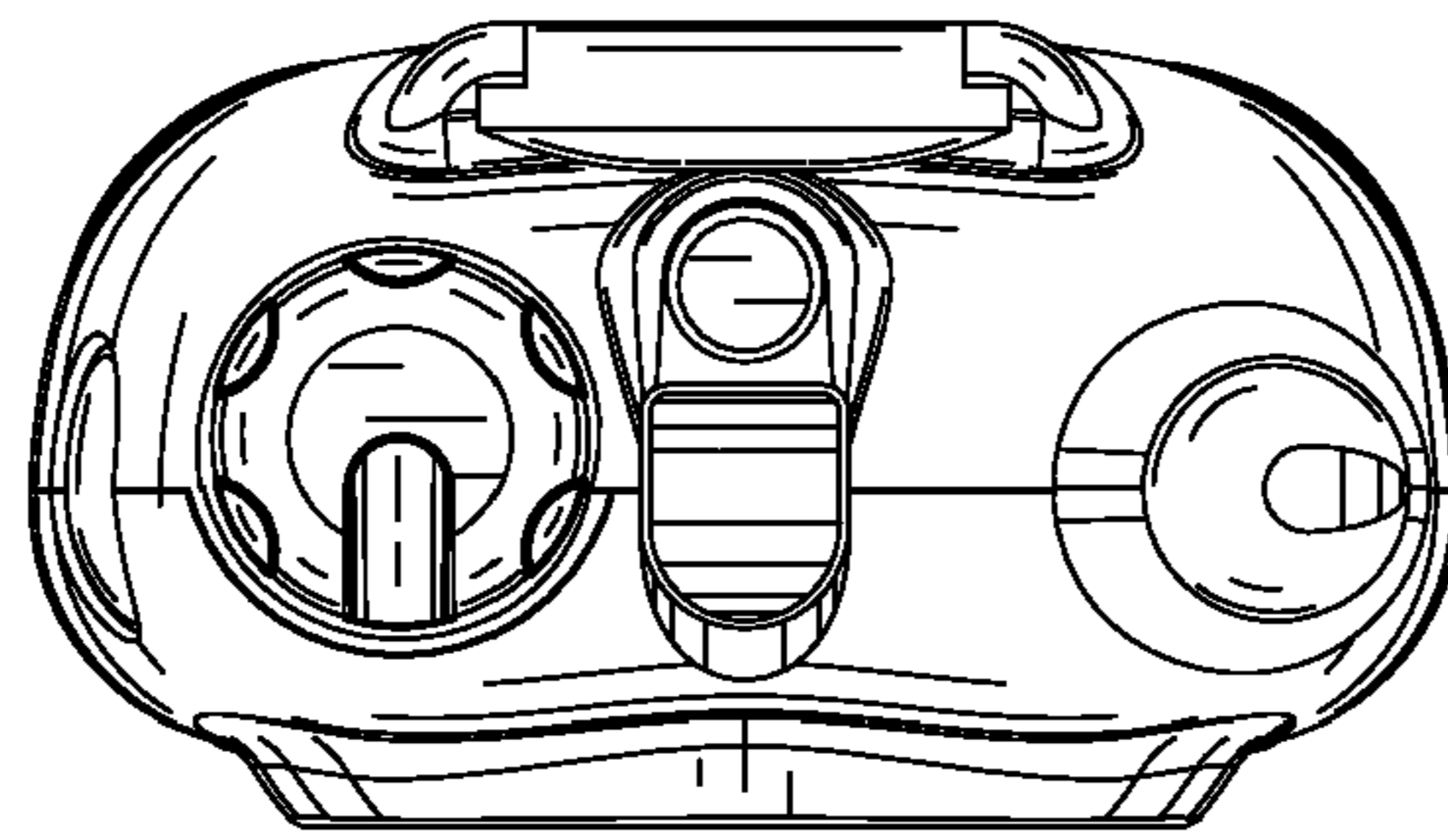

FIG. 7

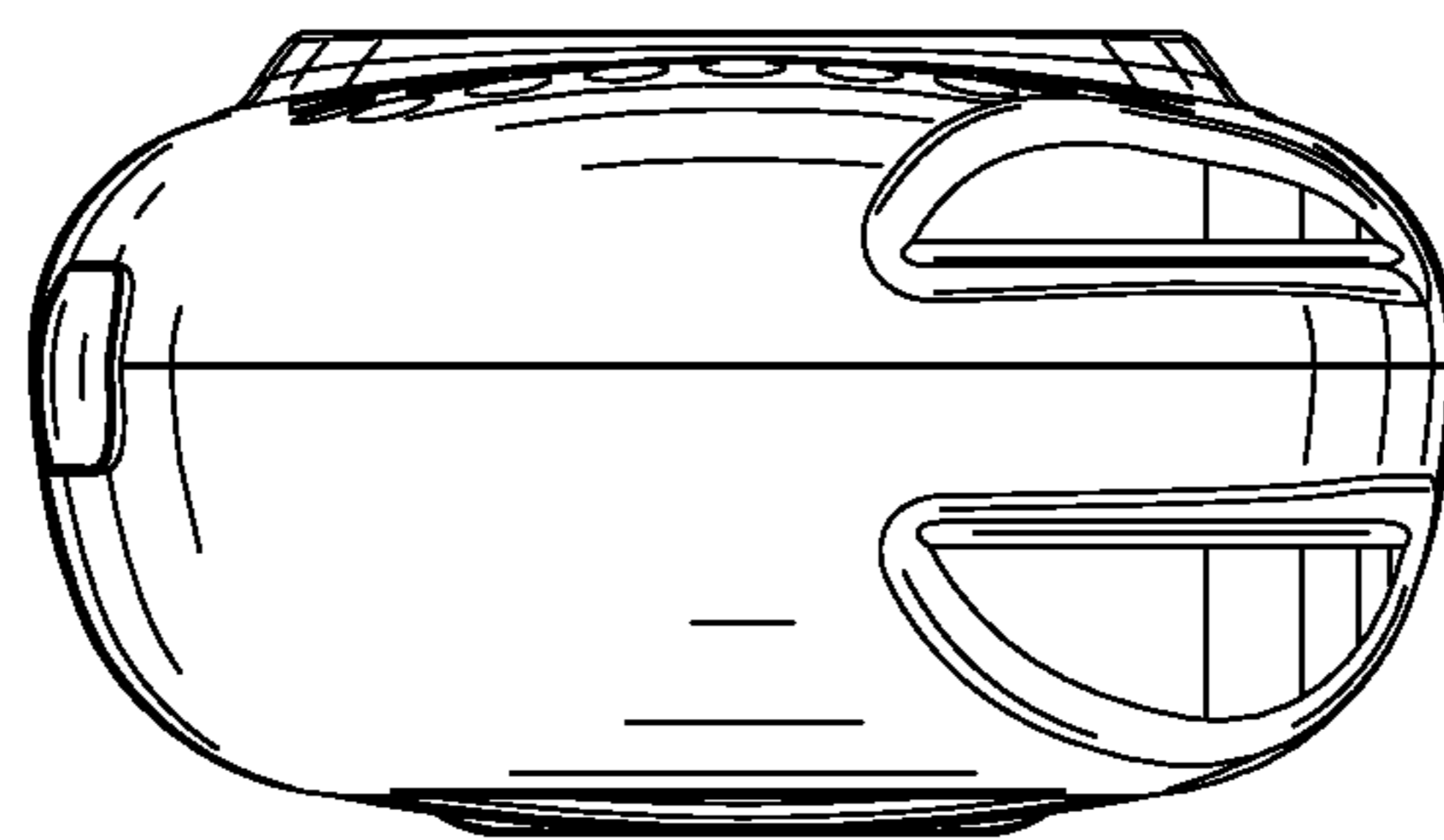

FIG. 8