



US00D635901S

(12) **United States Design Patent**  
**Anzi**

(10) **Patent No.:** **US D635,901 S**

(45) **Date of Patent:** **\*\* Apr. 12, 2011**

(54) **STEERING WHEEL FOR A MOTOR VEHICLE**

D442,129 S \* 5/2001 Schmitt ..... D12/176  
D483,305 S \* 12/2003 Okumura ..... D12/176  
D521,914 S \* 5/2006 Pfeiffer ..... D12/176  
D619,517 S \* 7/2010 Granata ..... D12/176

(75) Inventor: **Johnny Anzi**, Verona (IT)

\* cited by examiner

(73) Assignee: **Grant Products International, Inc.**,  
Duarte, CA (US)

*Primary Examiner* — Melody N Brown

(\*\*) Term: **14 Years**

(74) *Attorney, Agent, or Firm* — Venable LLP; Stefan Kirchanski

(21) Appl. No.: **29/368,054**

(57) **CLAIM**

(22) Filed: **Aug. 17, 2010**

The ornamental design for a steering wheel for a motor vehicle, as shown and described.

(51) **LOC (9) Cl.** ..... **12-16**

(52) **U.S. Cl.** ..... **D12/176**

(58) **Field of Classification Search** ..... D12/175,  
D12/176; 74/552, 558, 558.5

See application file for complete search history.

**DESCRIPTION**

FIG. 1 is a top left perspective view of a steering wheel for a motor vehicle showing my design;  
FIG. 2 is a front view thereof;  
FIG. 3 is a rear view thereof;  
FIG. 4 is a left side view thereof;  
FIG. 5 is a right side view thereof;  
FIG. 6 is a top view thereof; and,  
FIG. 7 is a bottom view thereof.

(56) **References Cited**

**U.S. PATENT DOCUMENTS**

D267,248 S \* 12/1982 Poteet ..... D12/176  
D312,435 S \* 11/1990 Funabashi et al. .... D12/176  
D321,497 S \* 11/1991 Whitley, II ..... D12/176  
D356,765 S \* 3/1995 DiMatteo ..... D12/176

**1 Claim, 6 Drawing Sheets**

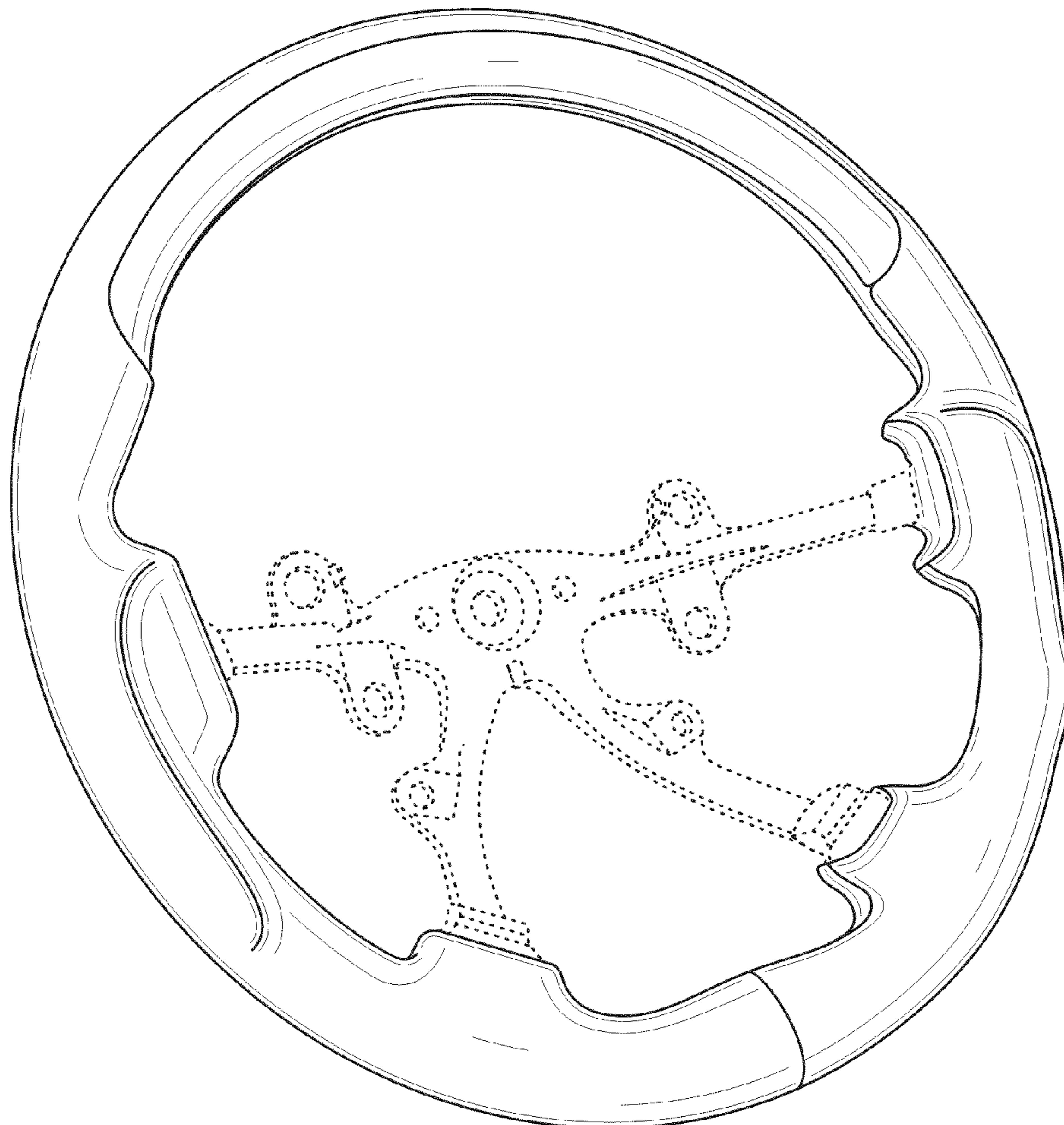

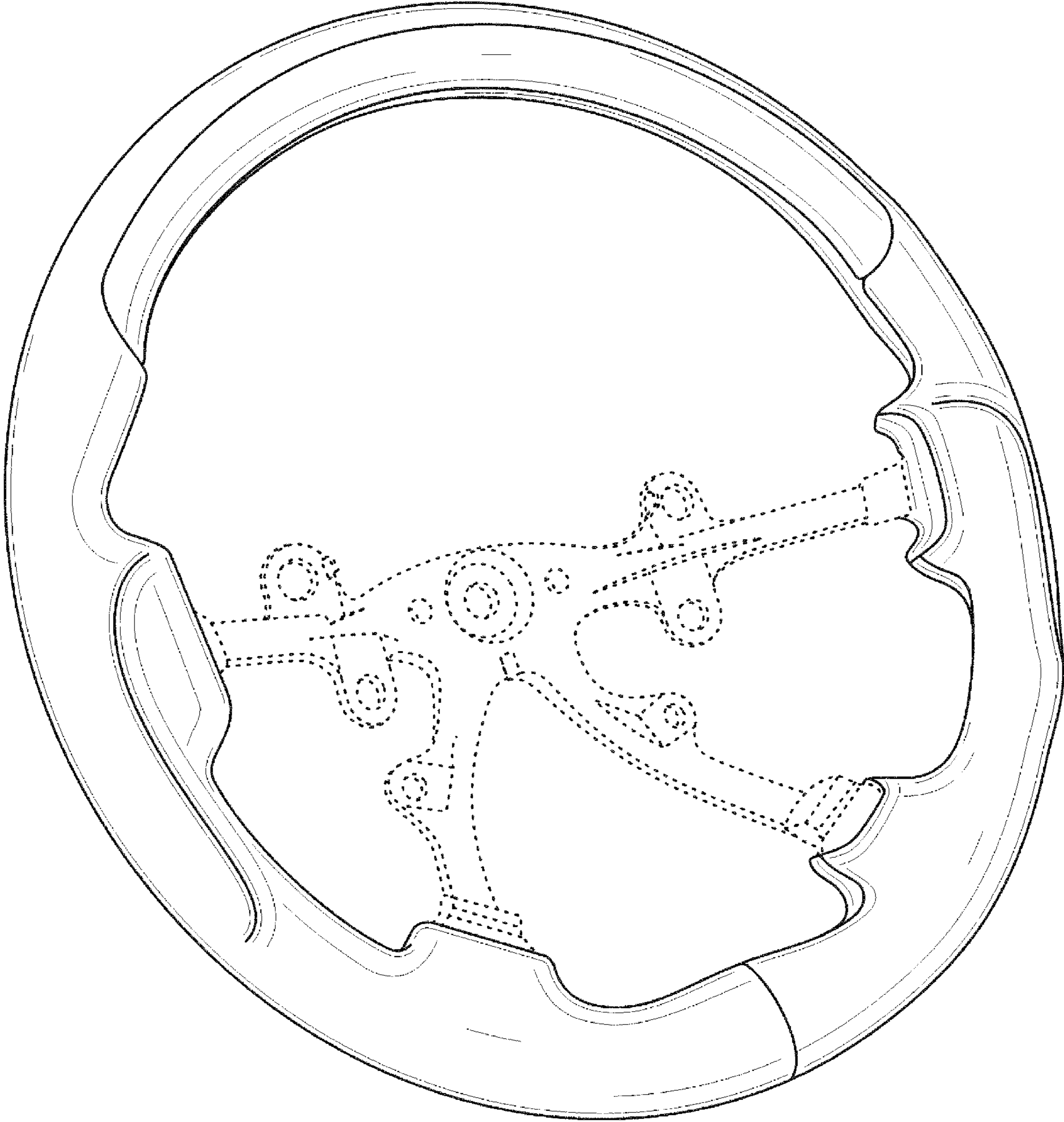

FIG. 1

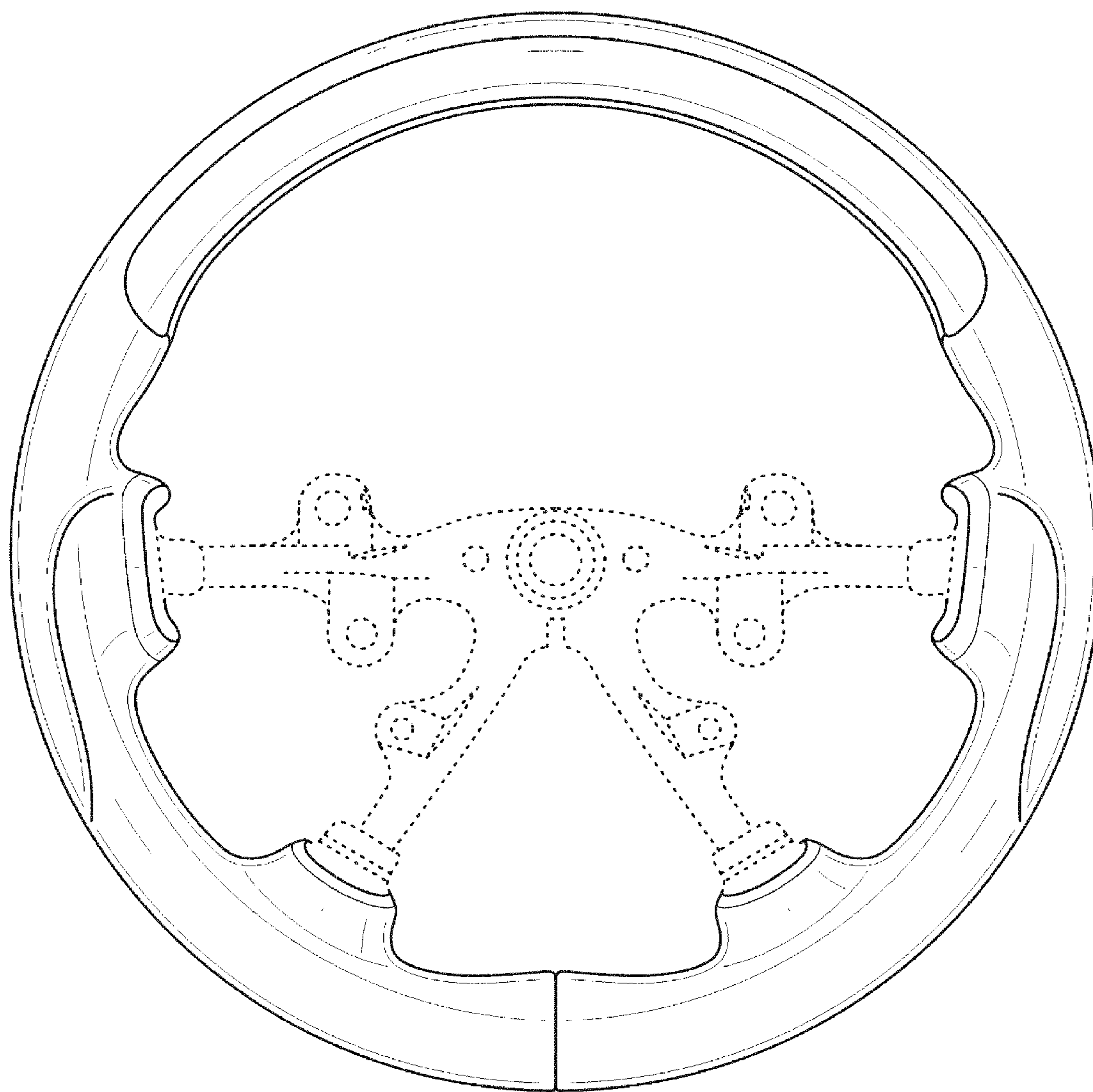

FIG. 2

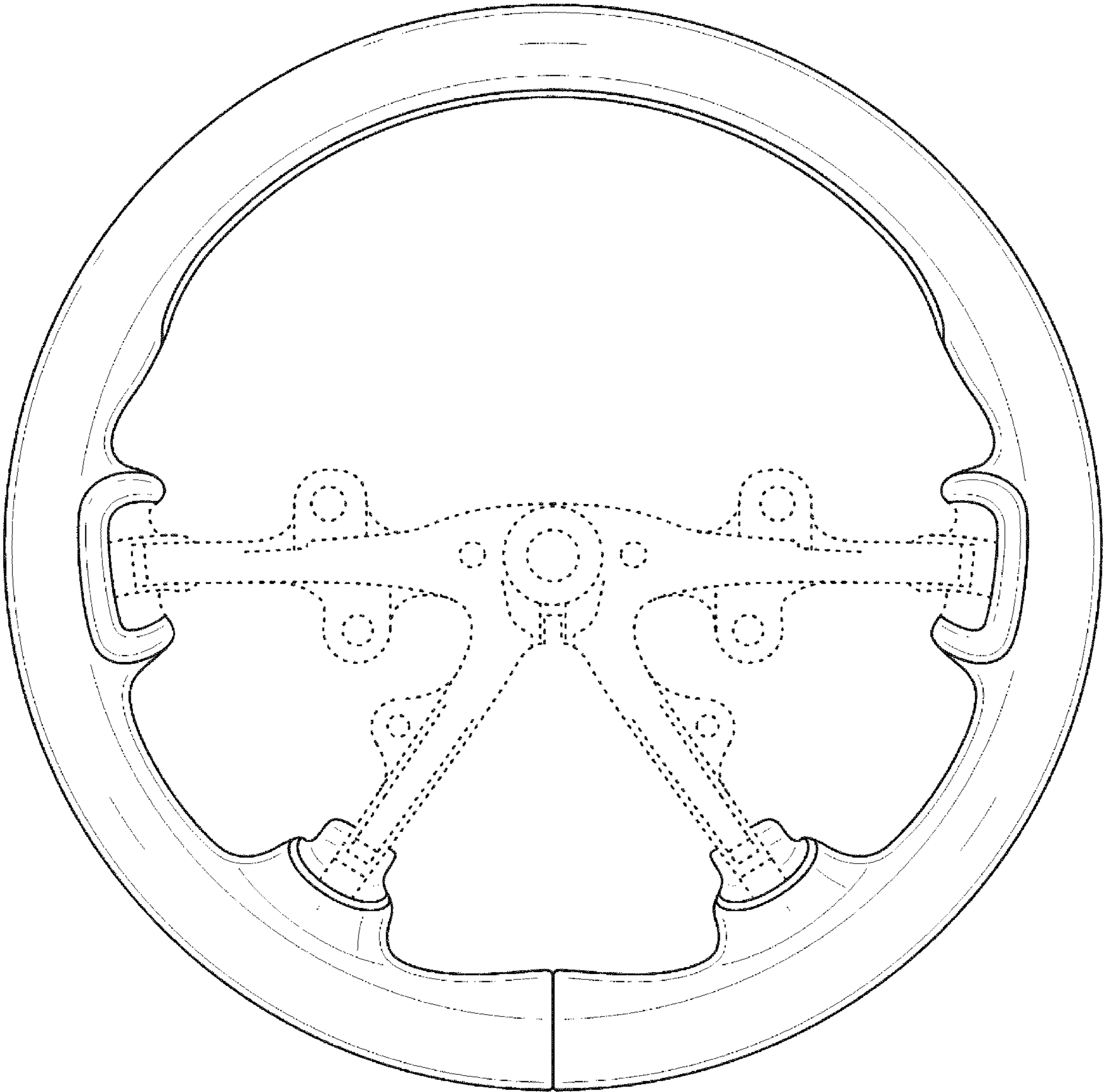

FIG. 3

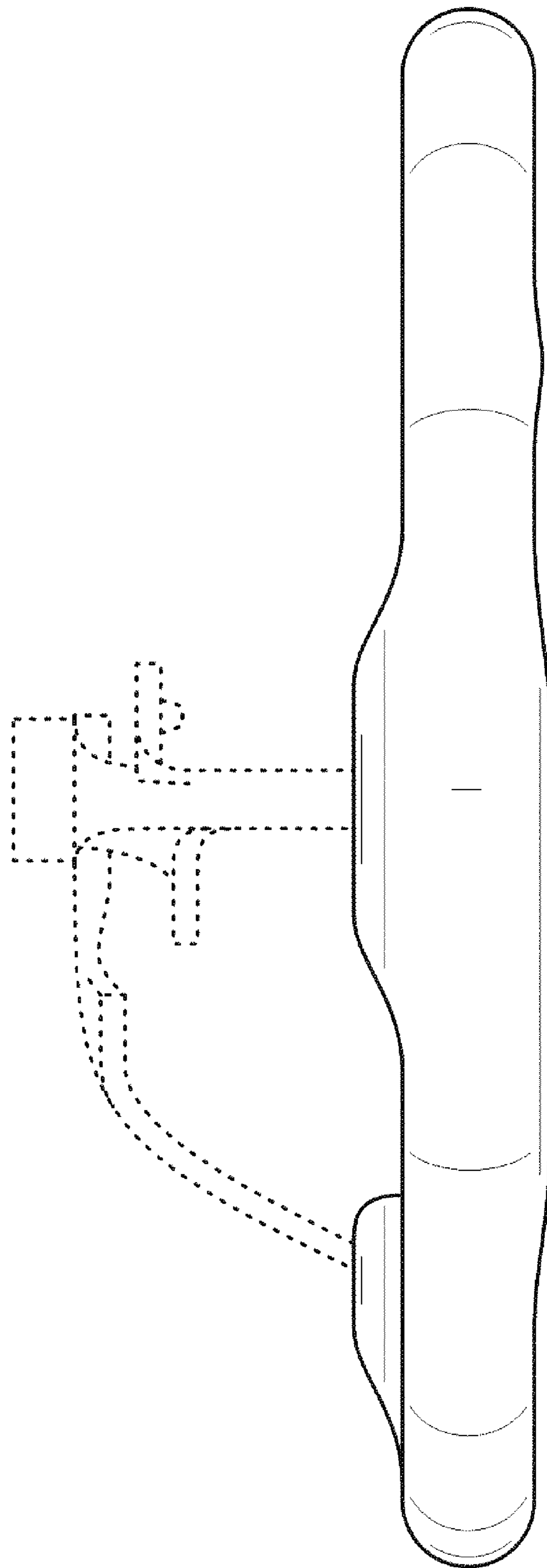

FIG. 4

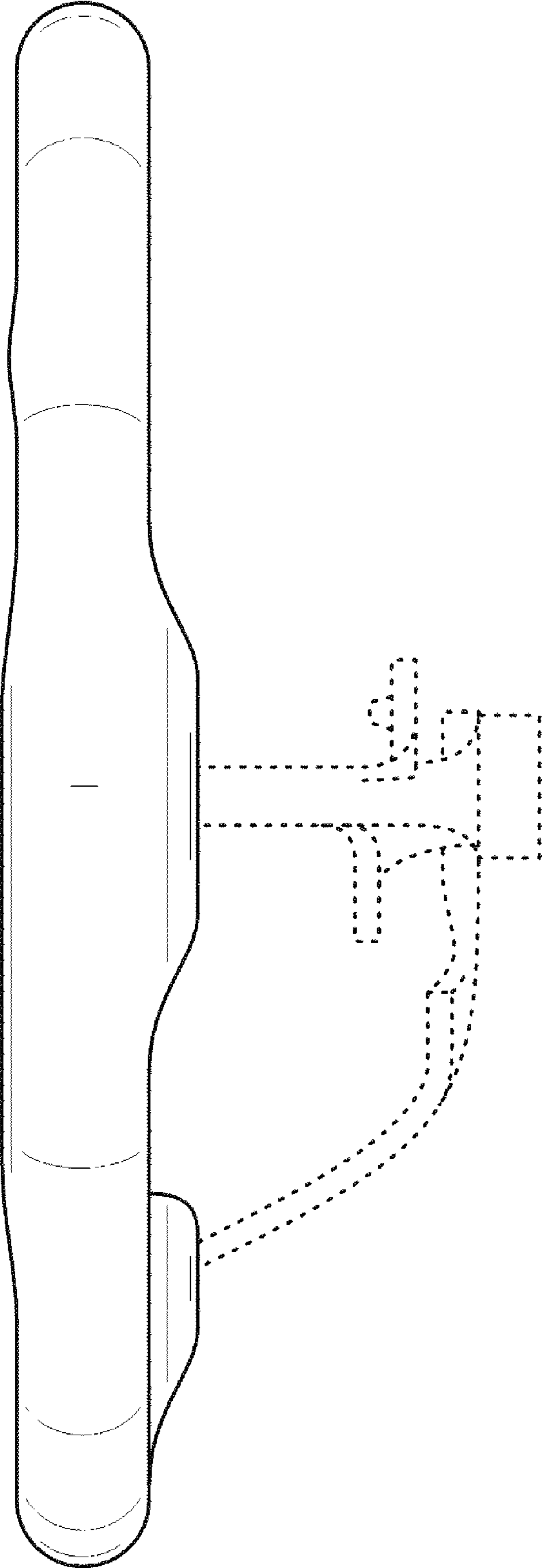

FIG. 5

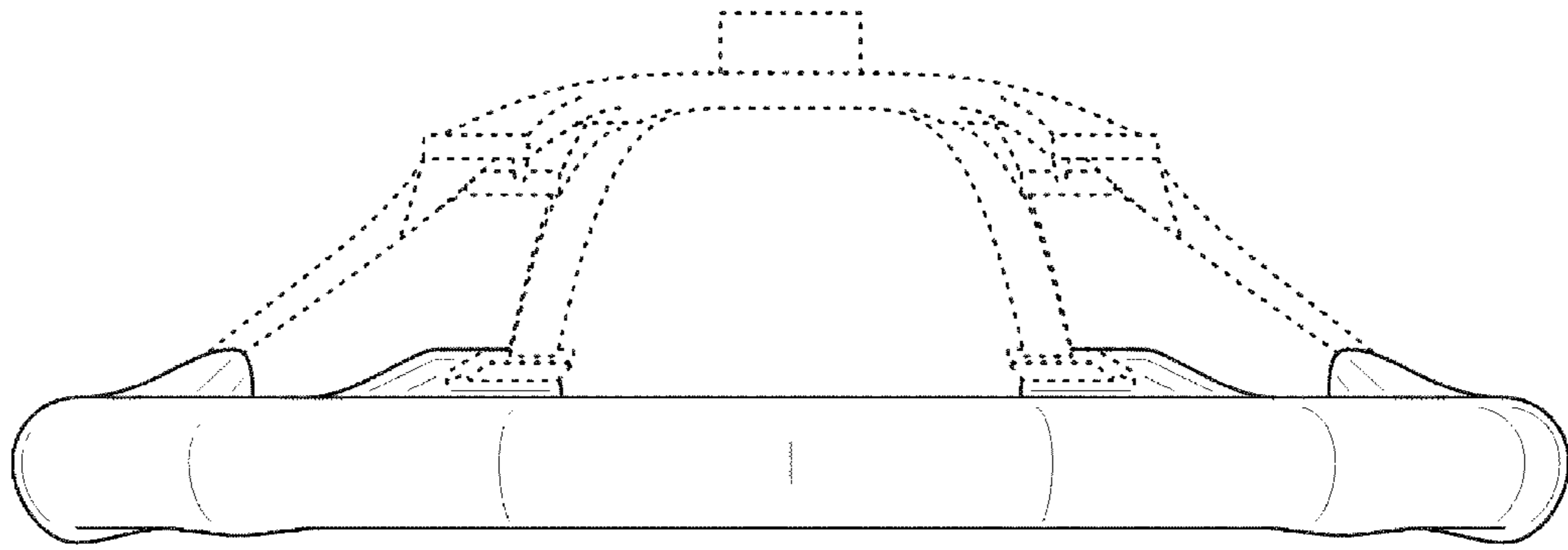

FIG. 6

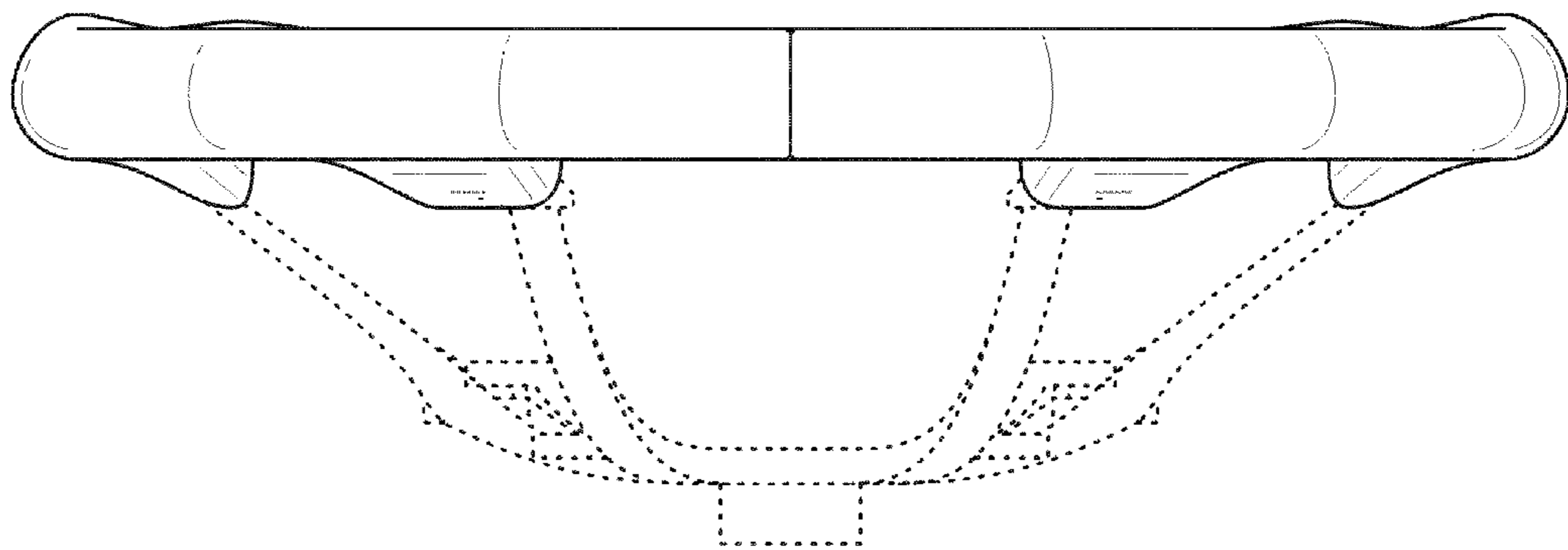

FIG. 7