



US00D635892S

(12) **United States Design Patent**
Beebe

(10) **Patent No.:** **US D635,892 S**

(45) **Date of Patent:** **** Apr. 12, 2011**

(54) **MULTIPURPOSE BAND**

(76) Inventor: **Cindy L. Beebe**, Apopka, FL (US)

(**) Term: **14 Years**

(21) Appl. No.: **29/370,632**

(22) Filed: **Aug. 16, 2010**

(51) **LOC (9) Cl.** **02-07**

(52) **U.S. Cl.** **D11/216**

(58) **Field of Classification Search** D11/1-2,
D11/200-201, 206-210, 214-218, 222; 24/163 R,
24/169-171, 173, 177-179, 191, 194-195,
24/197, 200, 614-616, 625; D14/223; D3/327
See application file for complete search history.

(56) **References Cited**

U.S. PATENT DOCUMENTS

D216,075 S * 11/1969 D'elia et al. D3/327
D361,362 S * 8/1995 Hoard D21/805

D513,249 S * 12/2005 Hirakawa et al. D14/223
D541,190 S * 4/2007 Plzak D11/200
D592,097 S * 5/2009 Androuais D11/222

* cited by examiner

Primary Examiner — Ralf Seifert

(74) *Attorney, Agent, or Firm* — William M. Hobby, III

(57) **CLAIM**

The ornamental design for a multipurpose band, as shown and described.

DESCRIPTION

FIG. 1 is a top plan view of my new multipurpose band;
FIG. 2 is a right side elevation;
FIG. 3 is a bottom plan view;
FIG. 4 is a right end elevation;
FIG. 5 is a left end elevation; and,
FIG. 6 is a perspective view being used to hold a purse to a chair.

The broken lines are for illustration purposes and form no part of the claimed design.

1 Claim, 2 Drawing Sheets

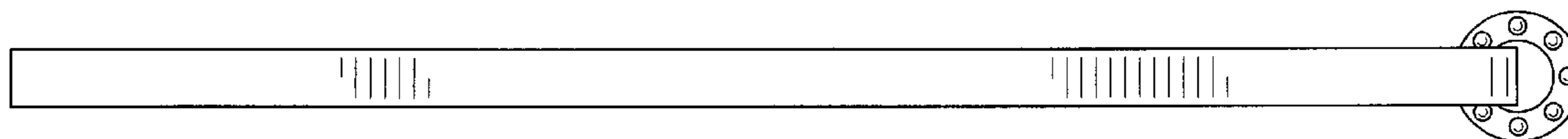

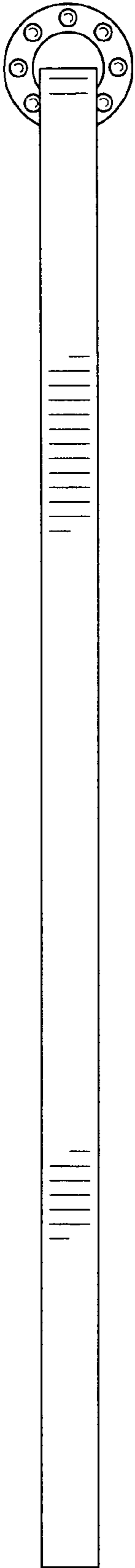

FIG. 1

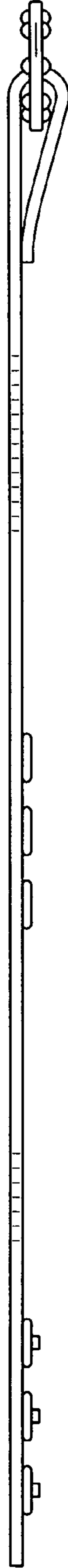

FIG. 2

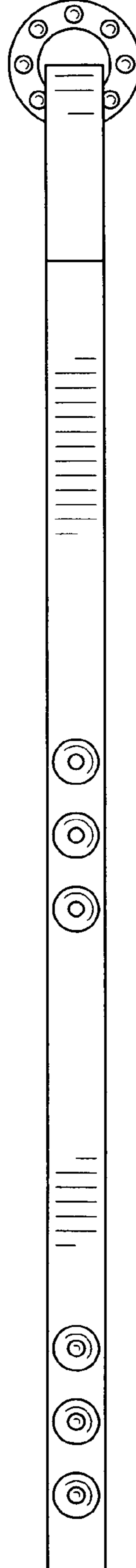

FIG. 3

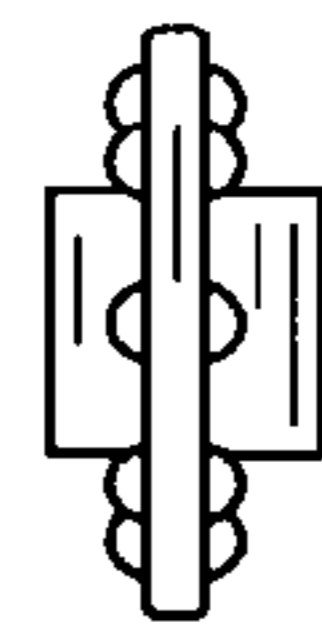

FIG. 4

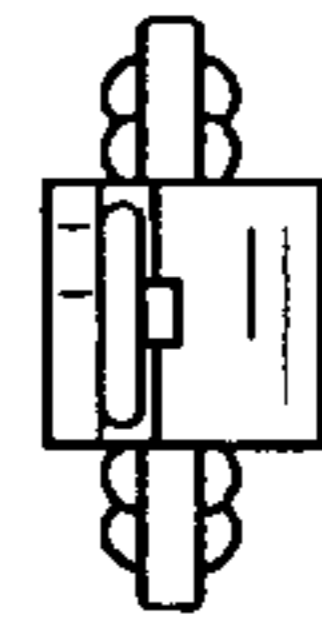

FIG. 5

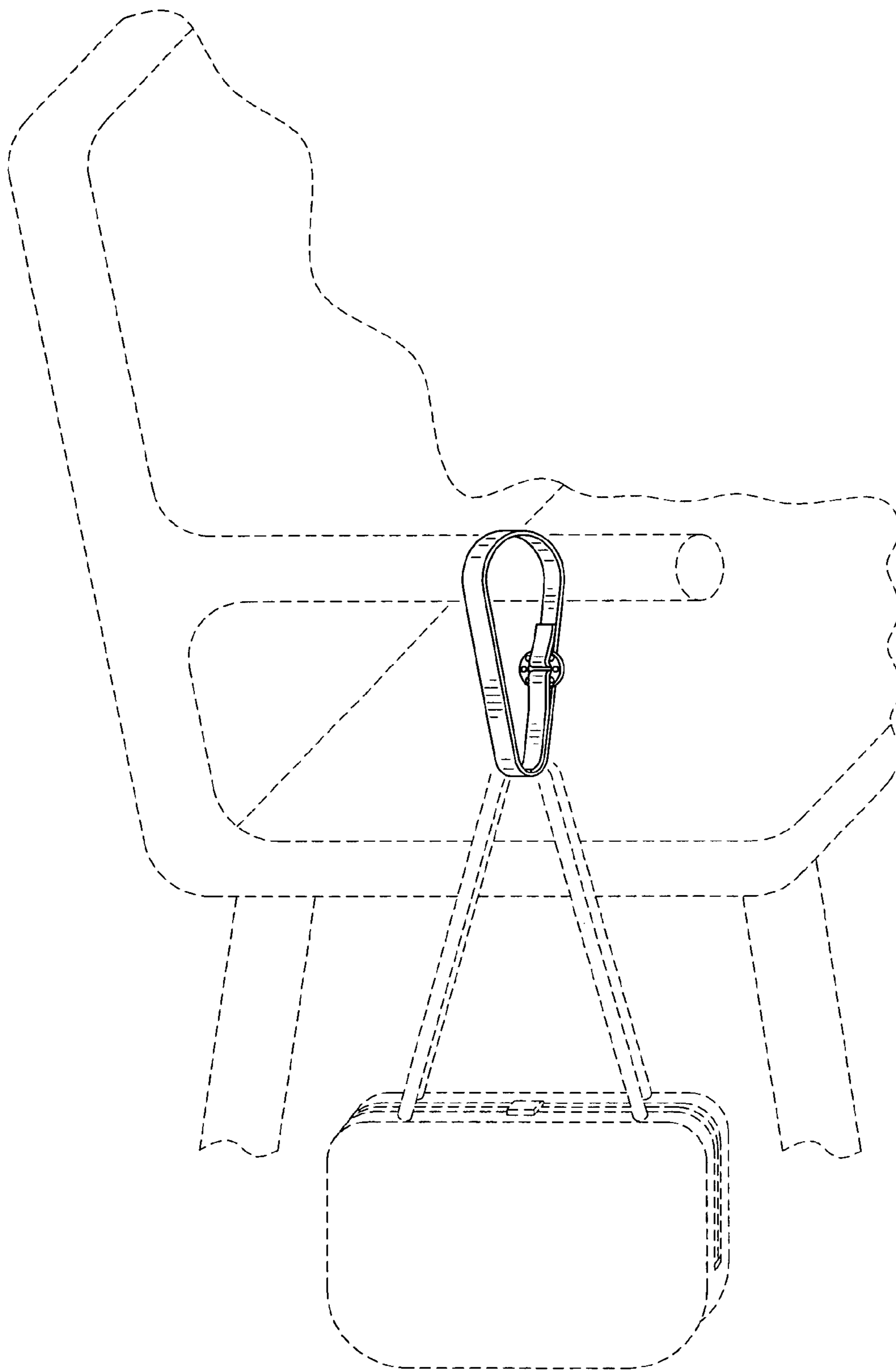

FIG. 6