



US00D635787S

(12) **United States Design Patent**
Ton

(10) **Patent No.:** **US D635,787 S**

(45) **Date of Patent:** **** Apr. 12, 2011**

(54) **PEDICURE SPA**

(76) **Inventor:** **Quy That Ton**, Baton Rouge, LA (US)

(**) **Term:** **14 Years**

(21) **Appl. No.:** **29/367,283**

(22) **Filed:** **Aug. 5, 2010**

(51) **LOC (9) Cl.** **06-01**

(52) **U.S. Cl.** **D6/336**

(58) **Field of Classification Search** D6/330,
D6/335-338, 340, 349-355, 358, 359, 364,
D6/366, 376, 491, 495, 500-502; 297/16.1,
297/39, 46, 135, 140, 156, 158.3, 158.4,
297/175, 177, 187, 195.1, 195.11, 211, 245,
297/423.1, 423.16, 445.1, 461, 462; D23/277,
D23/289; D24/204

See application file for complete search history.

(56) **References Cited**

U.S. PATENT DOCUMENTS

6,503,212 B2 *	1/2003	Park	601/158
D498,599 S *	11/2004	Luong	D6/336
D562,575 S *	2/2008	Le	D6/336
D576,806 S *	9/2008	Le	D6/336
D576,807 S *	9/2008	Le	D6/336
D588,707 S *	3/2009	Mai et al.	D24/213

D591,963 S *	5/2009	Lifeng	D6/336
D619,727 S *	7/2010	Le	D24/204
D620,126 S *	7/2010	Le	D24/204
D623,428 S *	9/2010	Galati et al.	D6/336

* cited by examiner

Primary Examiner — Sandra Snapp

(74) *Attorney, Agent, or Firm* — Duane Morris LLP

(57) **CLAIM**

The ornamental design for a pedicure spa, as shown and described.

DESCRIPTION

FIG. 1 is a perspective view showing the front, left and upper side of my new pedicure spa;
FIG. 2 is a perspective view showing the rear, right and upper side of the pedicure spa shown in FIG. 1;
FIG. 3 is a left side elevation view of the pedicure spa of FIG. 1;
FIG. 4 is a right side elevation view of the pedicure spa of FIG. 1;
FIG. 5 is a front elevation view of the pedicure spa of FIG. 1; and,
FIG. 6 is a rear elevation view of the pedicure spa of FIG. 1.
The broken lines shown in the drawings are for illustrative purposes only and form no part of the claimed design.

1 Claim, 3 Drawing Sheets

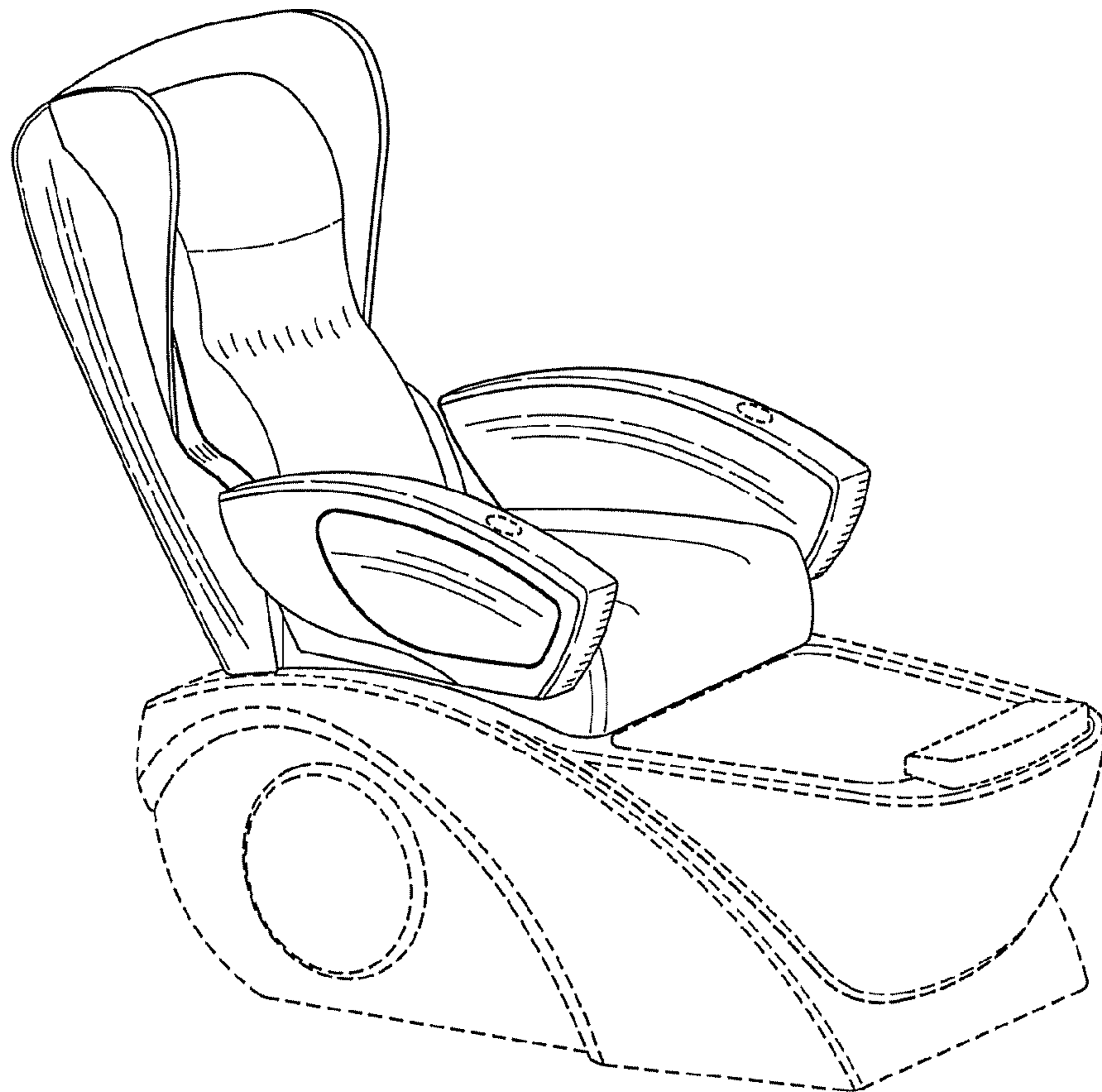

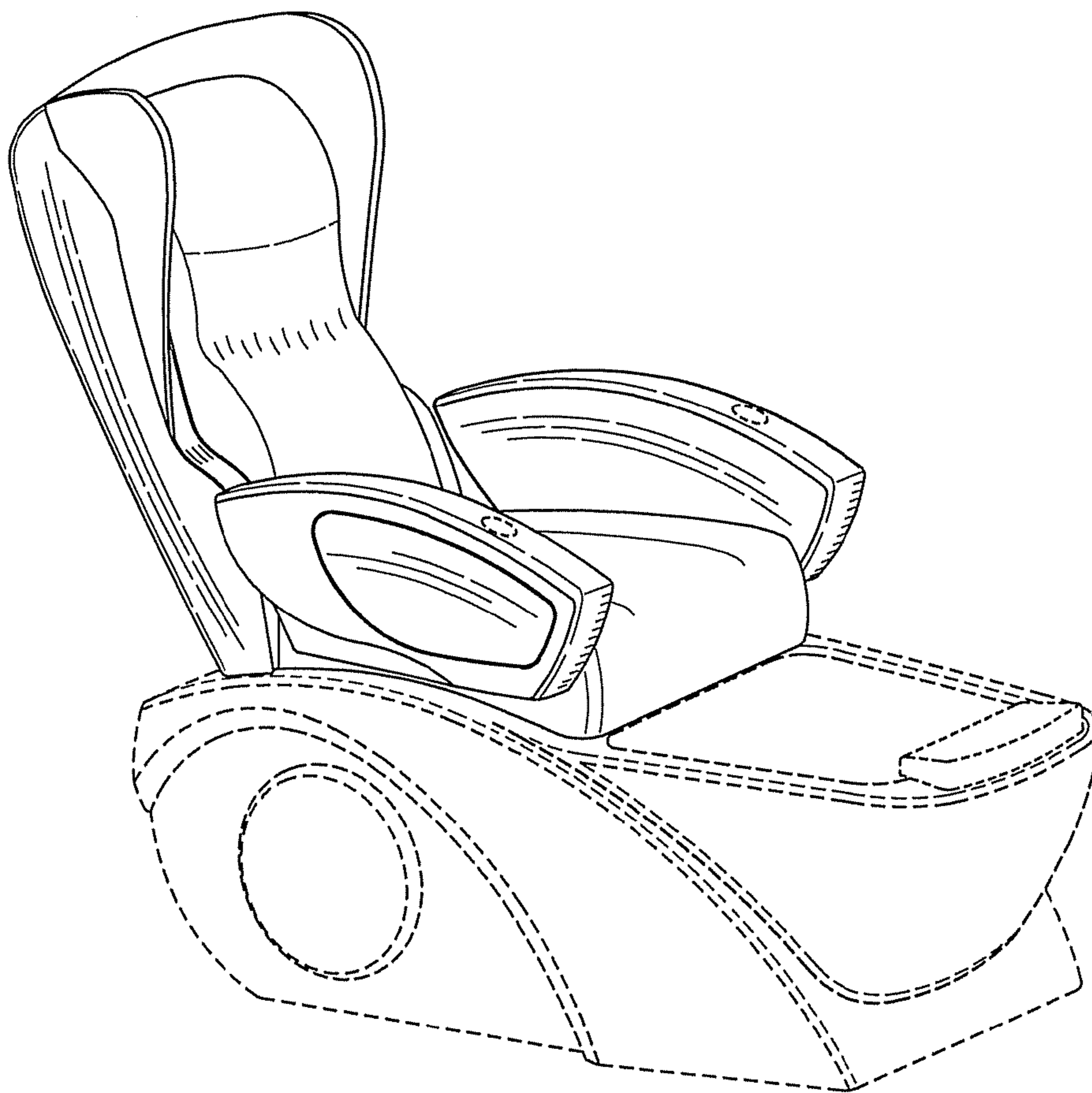

FIG. 1

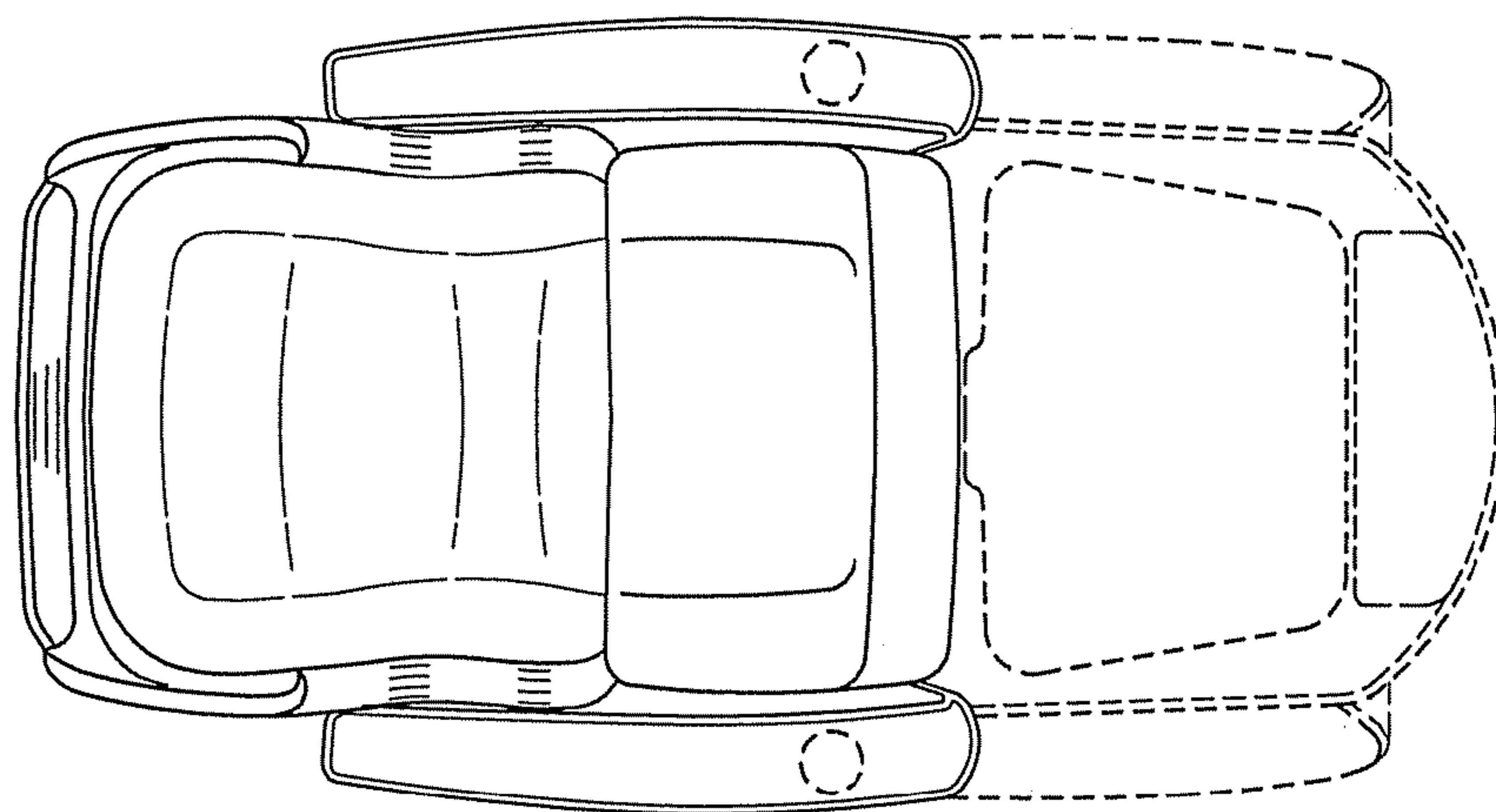

FIG. 2

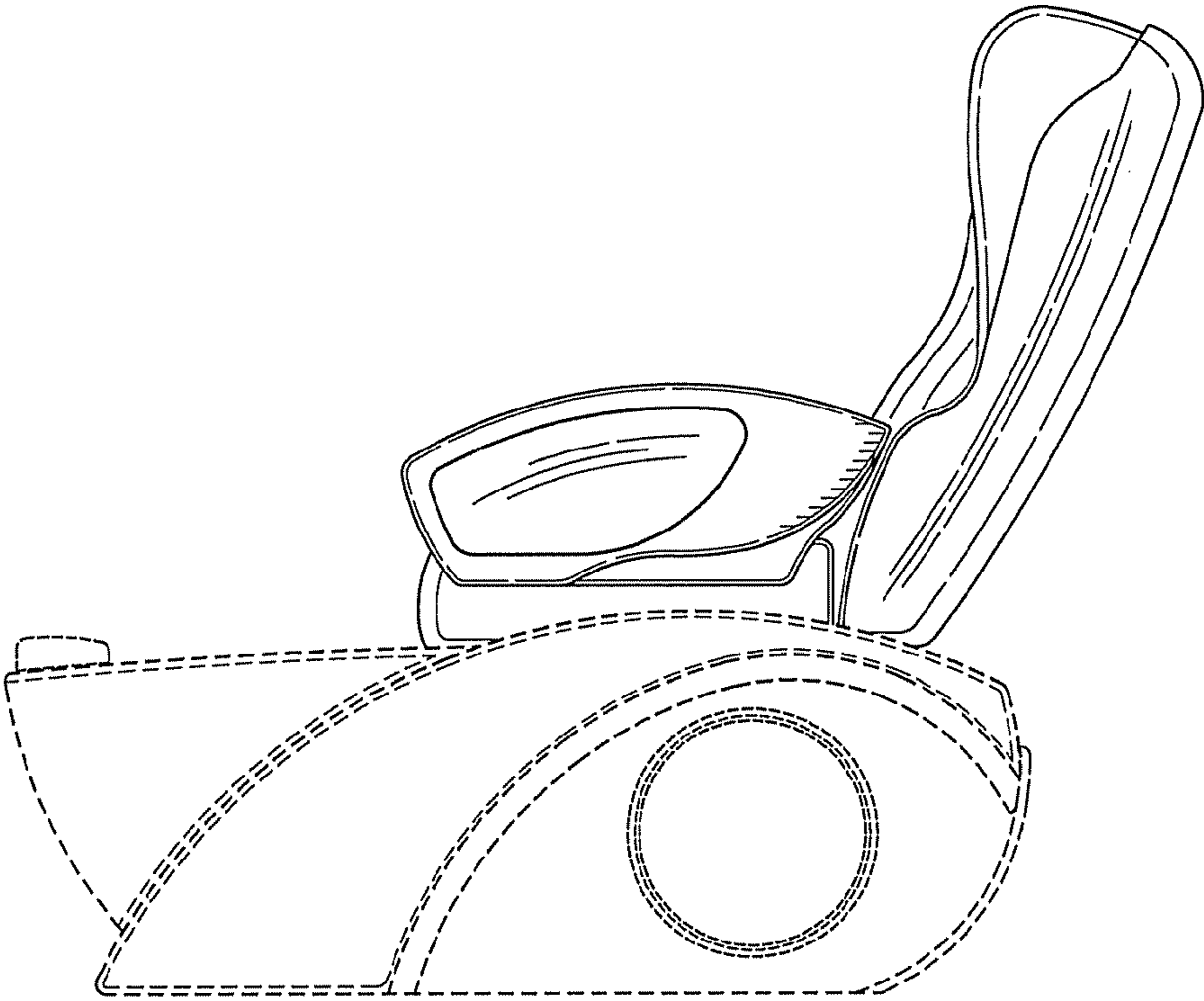

FIG. 3

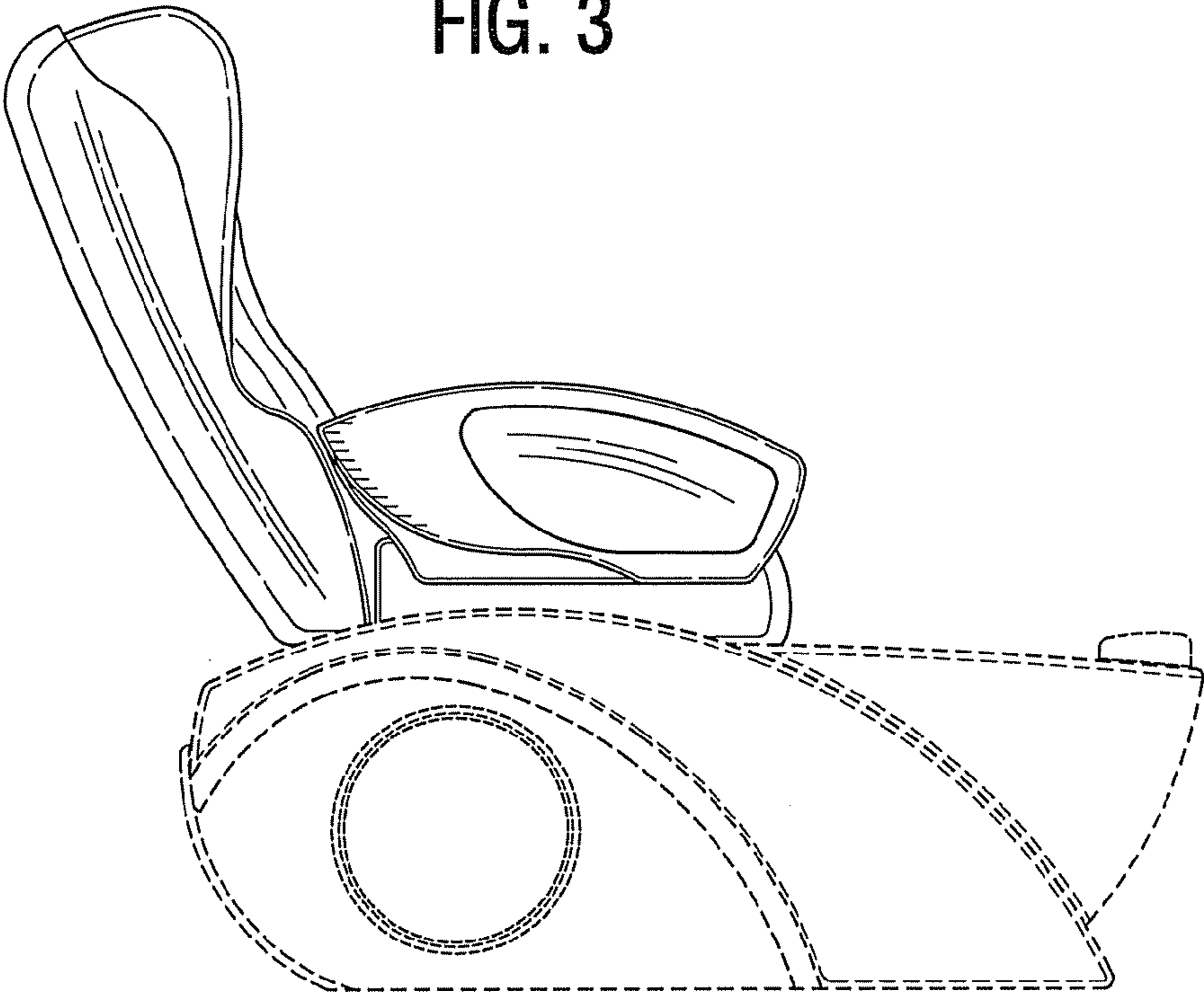

FIG. 4

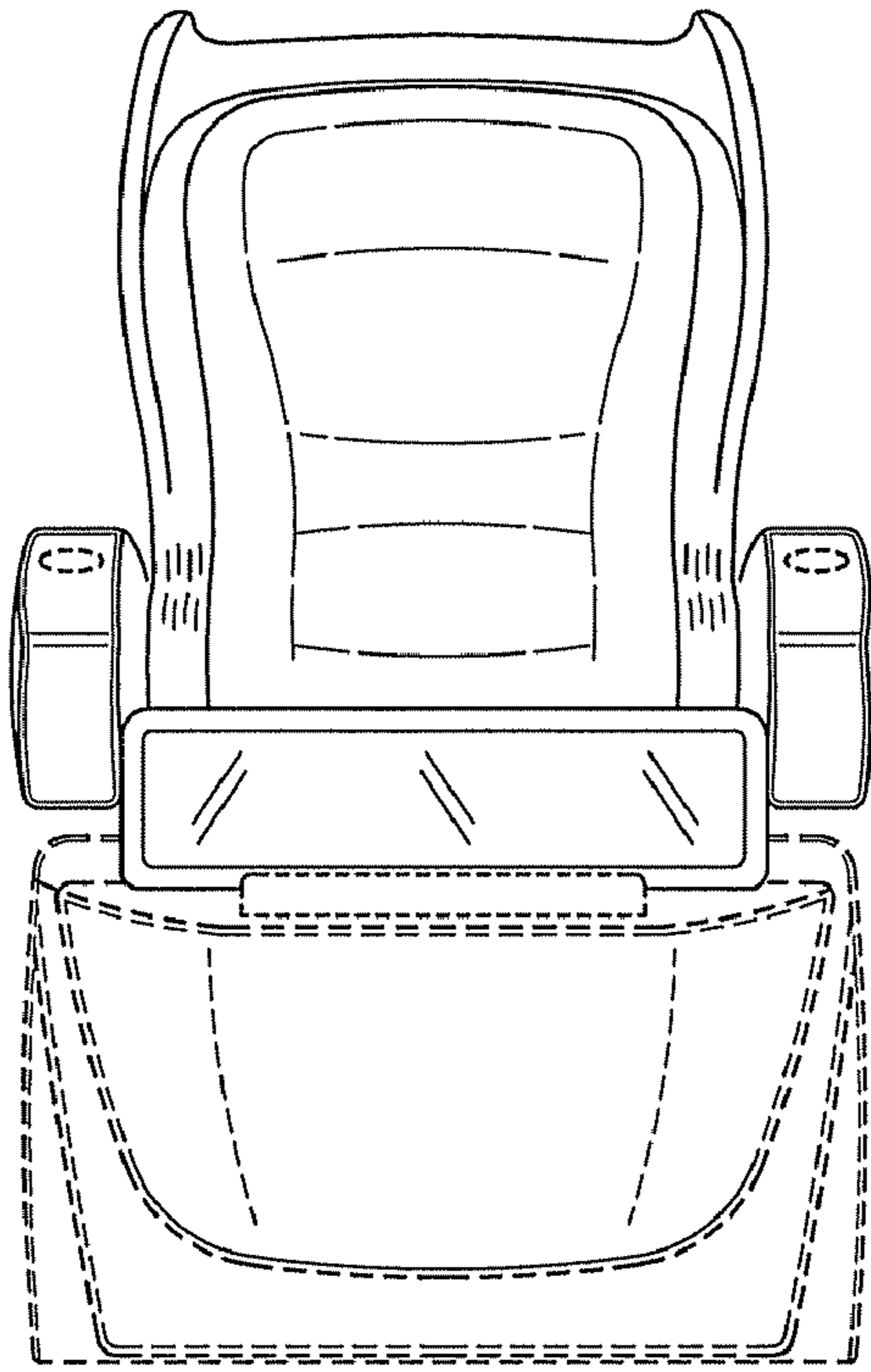

FIG. 5

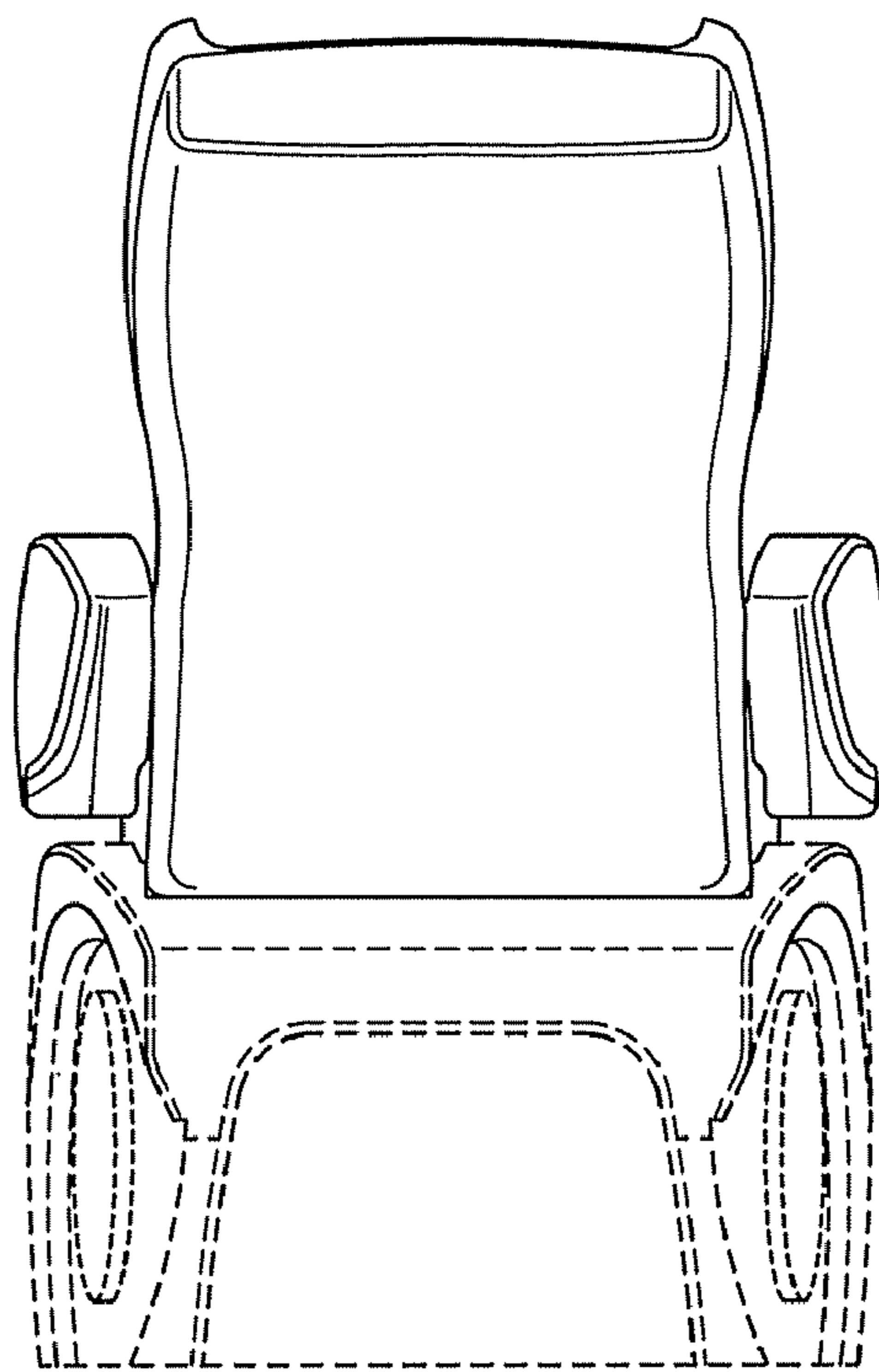

FIG. 6