



US00D635717S

(12) **United States Design Patent**
Furtek

(10) **Patent No.:** **US D635,717 S**

(45) **Date of Patent:** **** Apr. 5, 2011**

(54) **SHAVING RAZOR CARTRIDGE**

(75) Inventor: **Nicholas Leslie Furtek**, Ruislip (GB)

(73) Assignee: **The Gillette Company**, Boston, MA (US)

(**) Term: **14 Years**

(21) Appl. No.: **29/368,018**

(22) Filed: **Aug. 17, 2010**

(51) **LOC (9) Cl.** **28-03**

(52) **U.S. Cl.** **D28/47**

(58) **Field of Classification Search** D28/44-48;
30/32, 32.05, 34.1-34.2, 41, 44-46, 47-51,
30/57-58, 77-84, 526-539, 346.5-346.56,
30/346.61

See application file for complete search history.

(56) **References Cited**

U.S. PATENT DOCUMENTS

5,313,705	A	*	5/1994	Rivers et al.	30/50
D472,017	S	*	3/2003	Kite et al.	D28/47
D501,954	S	*	2/2005	Kite et al.	D28/47
D516,243	S	*	2/2006	Nakasuka	D28/47
D535,784	S		1/2007	Wonderley et al.		
D550,400	S	*	9/2007	Orloff et al.	D28/47
D565,245	S		3/2008	Wonderley		
D568,536	S		5/2008	Rhoad et al.		
D588,309	S		3/2009	Wonderley		
D589,210	S		3/2009	Wonderley et al.		
D601,753	S	*	10/2009	Cataudella et al.	D28/47
D615,704	S		5/2010	Wonderley et al.		

D617,949	S	*	6/2010	Lukan et al.	D28/47
D619,763	S	*	7/2010	Coresh	D28/48
D622,905	S	*	8/2010	Wain	D28/47
D625,883	S	*	10/2010	Wonderley	D28/47

* cited by examiner

Primary Examiner — Jennifer Rivard

(74) *Attorney, Agent, or Firm* — John M. Lipchitz; Kevin C. Johnson; Steven W. Miller

(57) **CLAIM**

The ornamental design for a shaving razor cartridge, as shown and described.

DESCRIPTION

FIG. 1 is a perspective view of a shaving razor cartridge of the present invention;

FIG. 2 is a front view thereof;

FIG. 3 is a rear view thereof;

FIG. 4 is a right view thereof;

FIG. 5 is a left view thereof;

FIG. 6 is a top view thereof;

FIG. 7 is a bottom view thereof;

FIG. 8 is a perspective view of a second embodiment thereof;

FIG. 9 is a front view thereof;

FIG. 10 is a rear view thereof;

FIG. 11 is a right view thereof;

FIG. 12 is a left view thereof;

FIG. 13 is a top view thereof; and,

FIG. 14 is a bottom view thereof.

The broken lines are shown for illustrative purposes only and form no part of the claimed design.

1 Claim, 8 Drawing Sheets

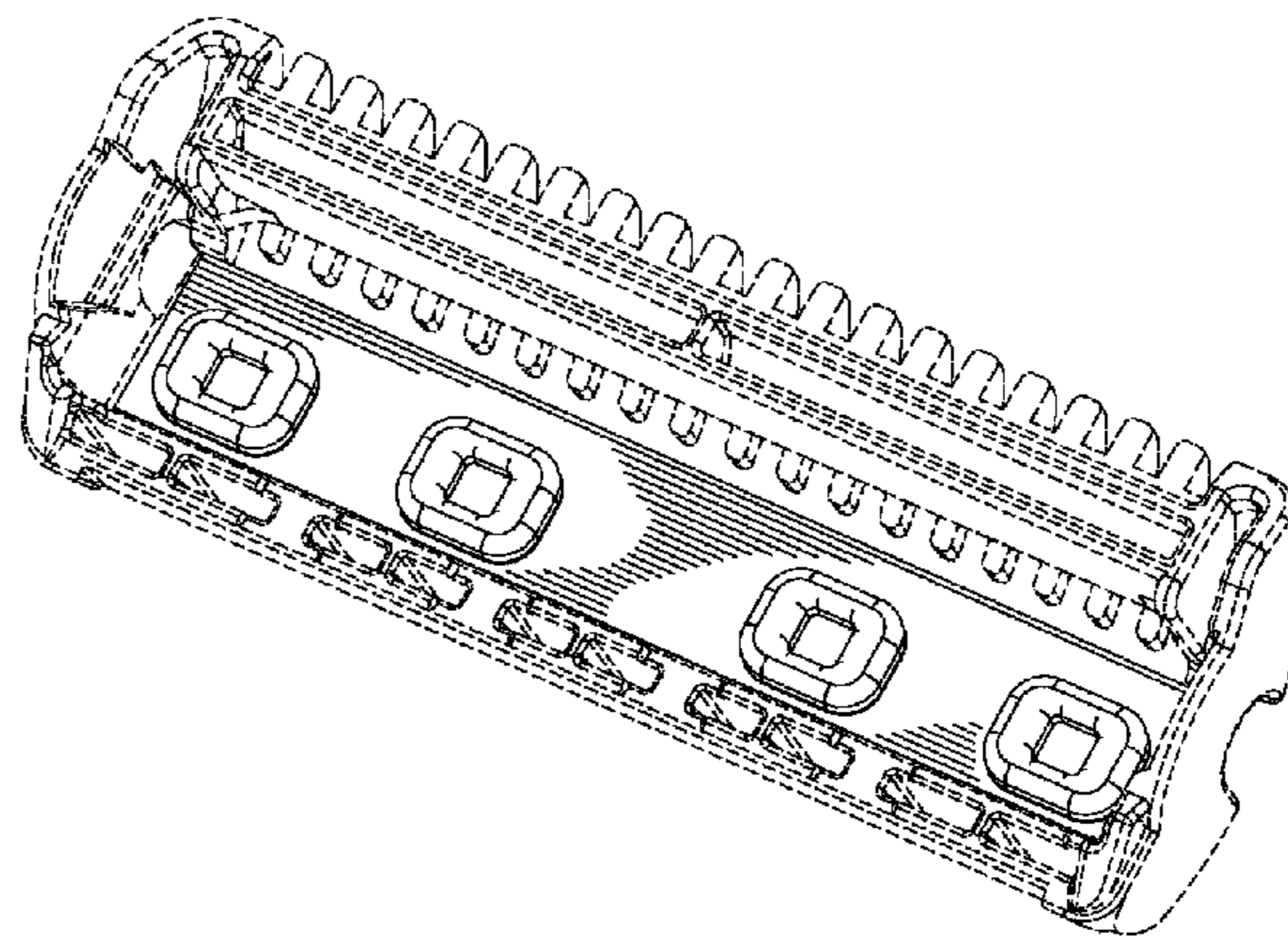
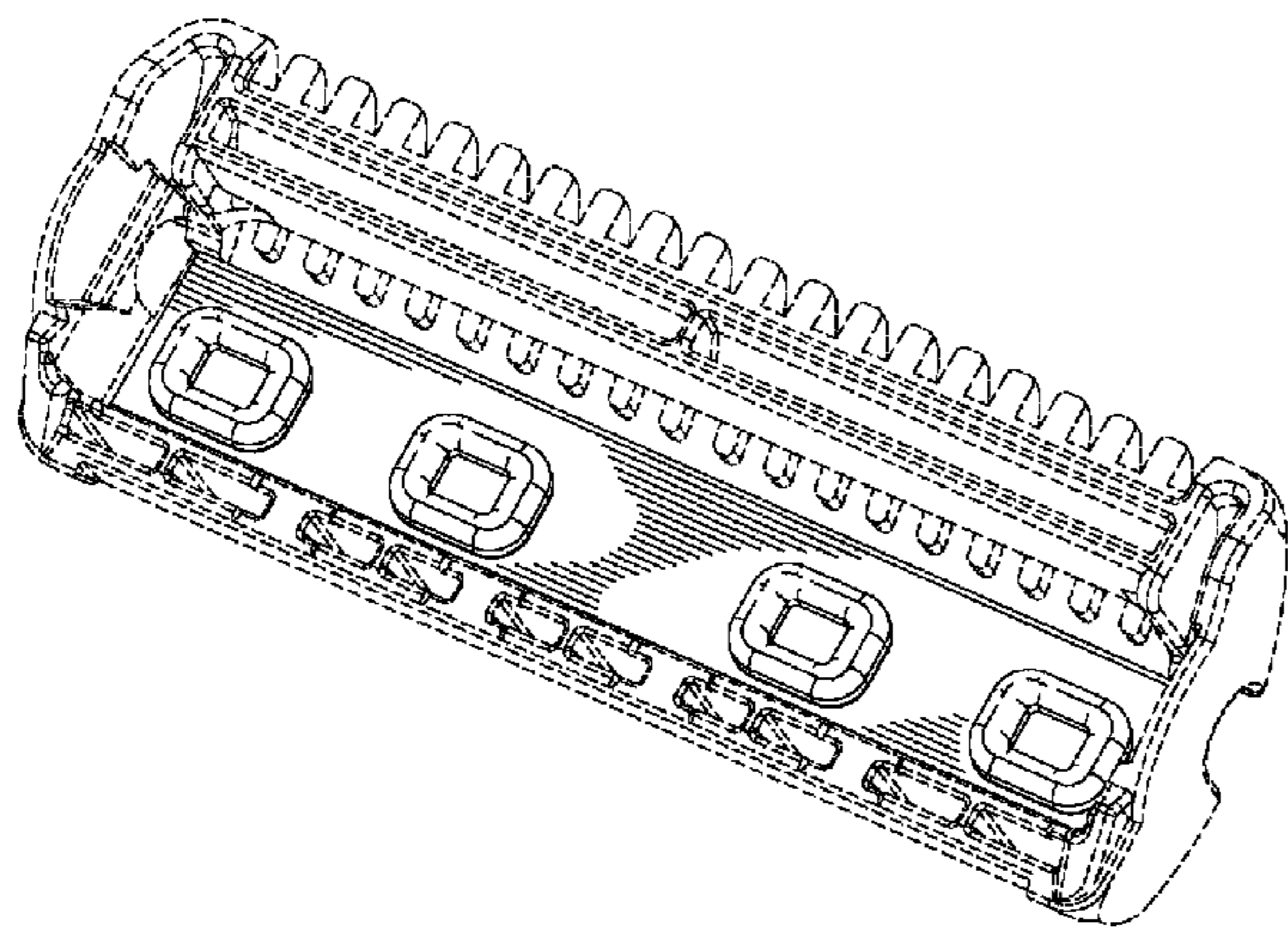

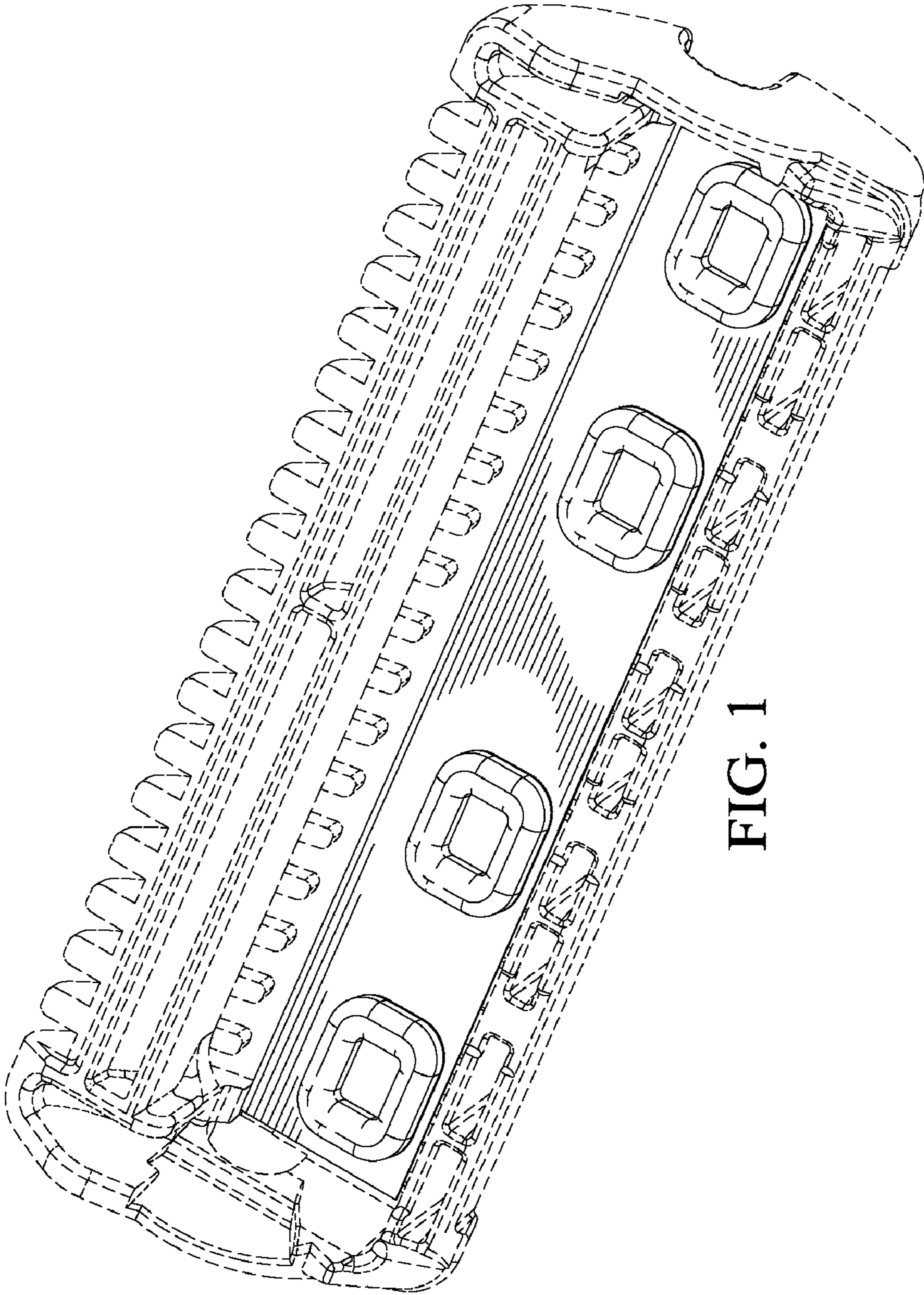

FIG. 1

FIG. 2

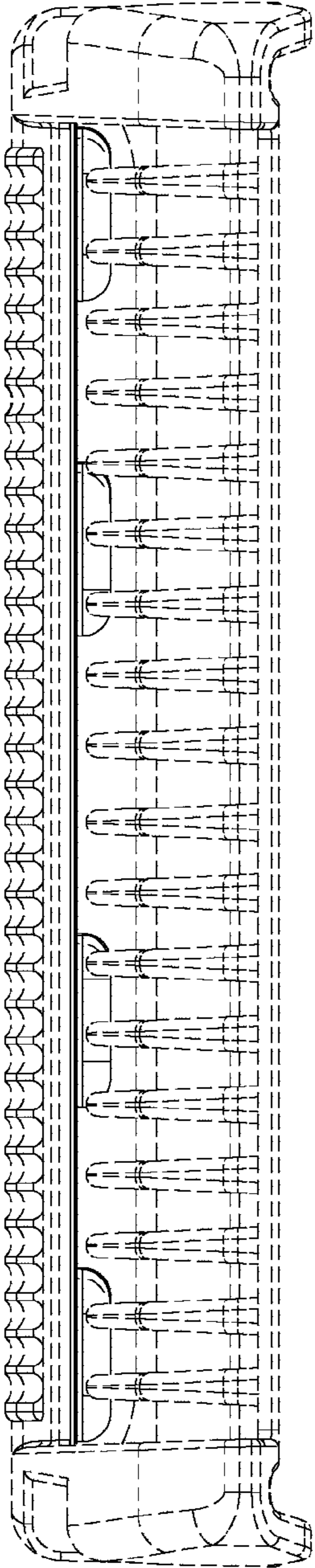
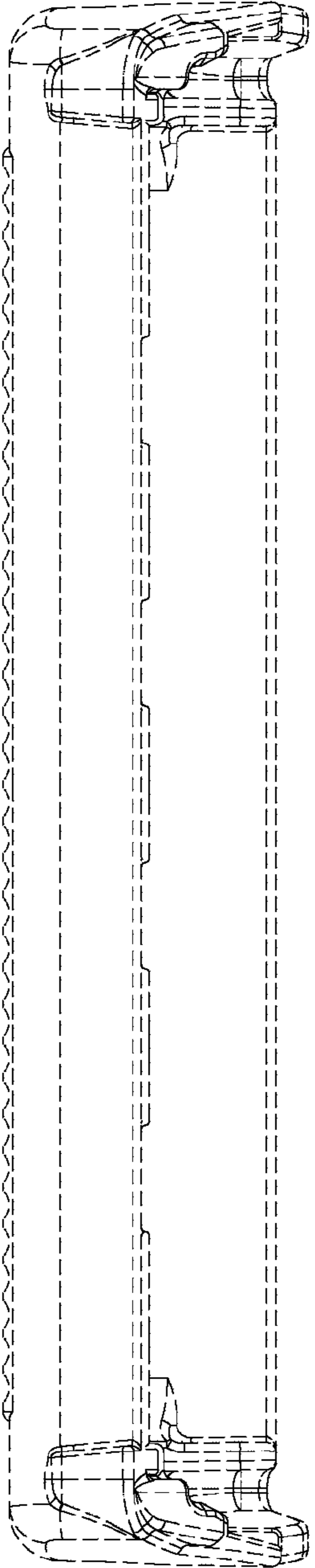

FIG. 3



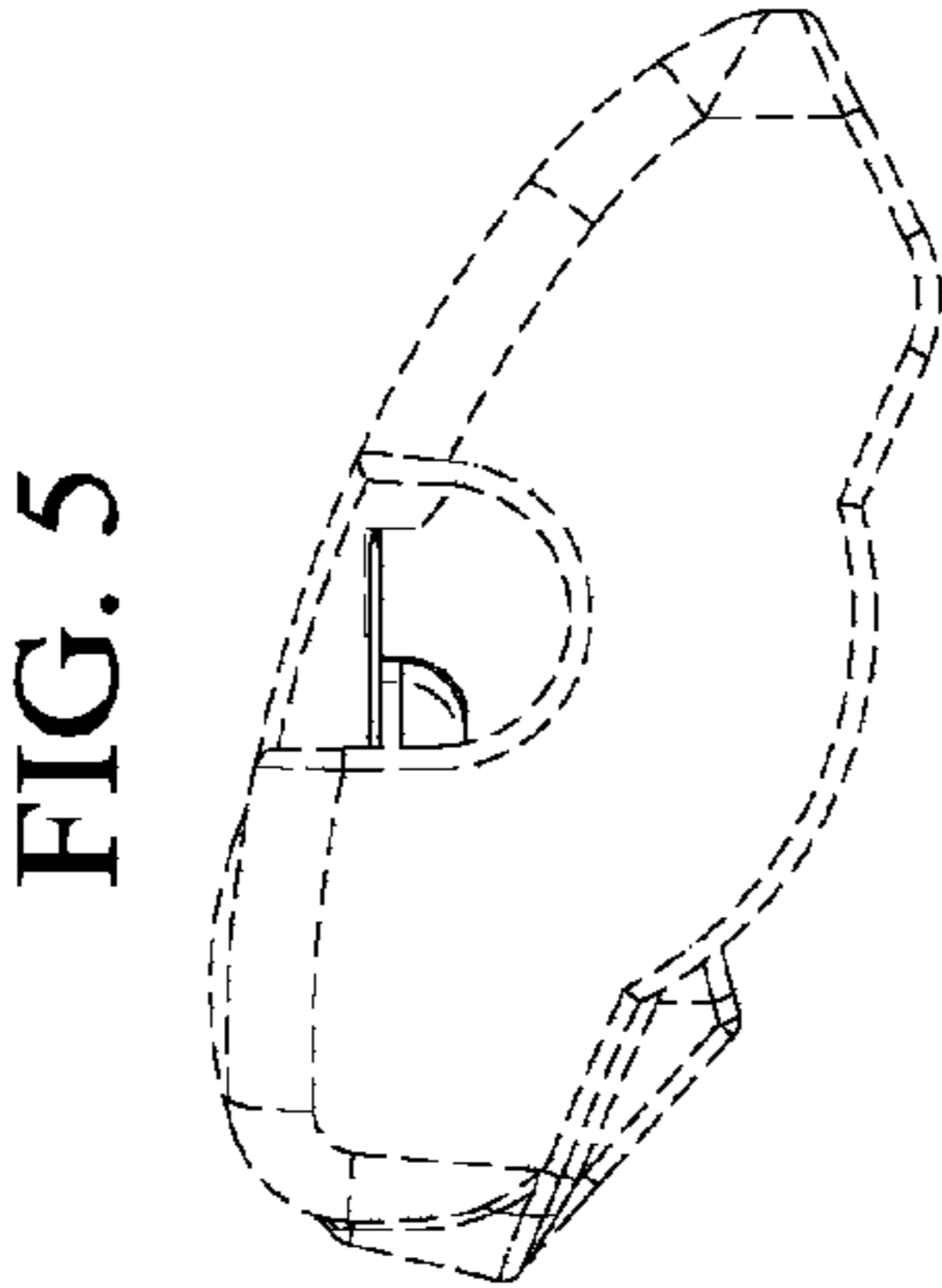

FIG. 4

FIG. 5

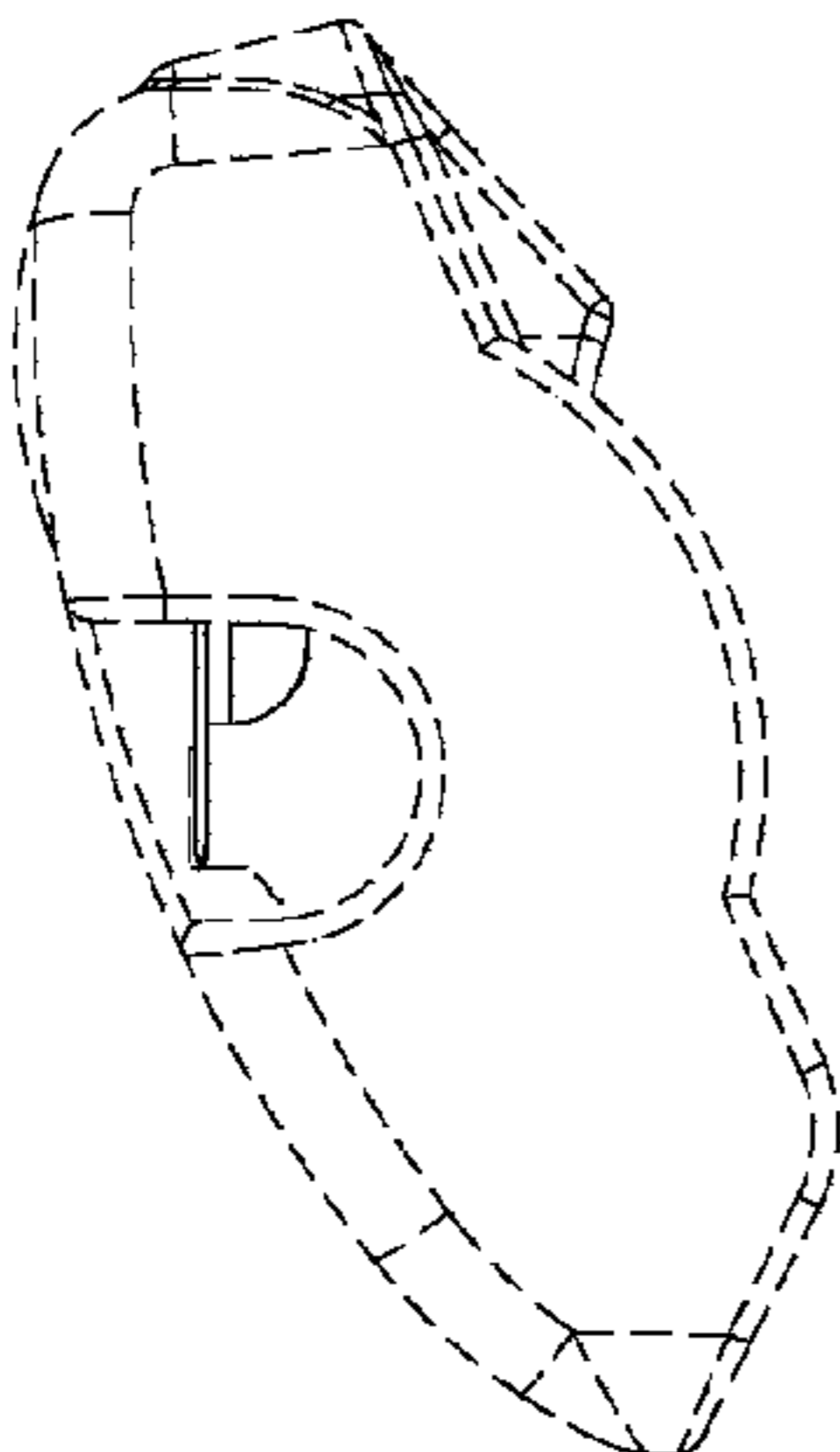

FIG. 6

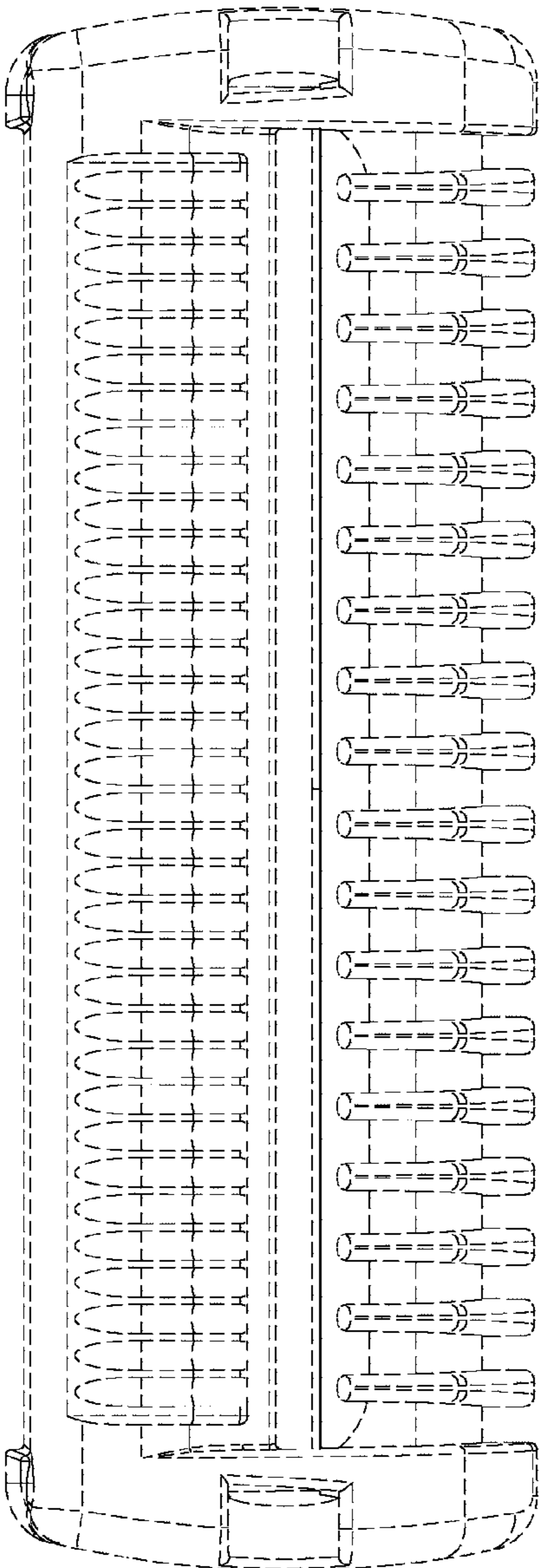
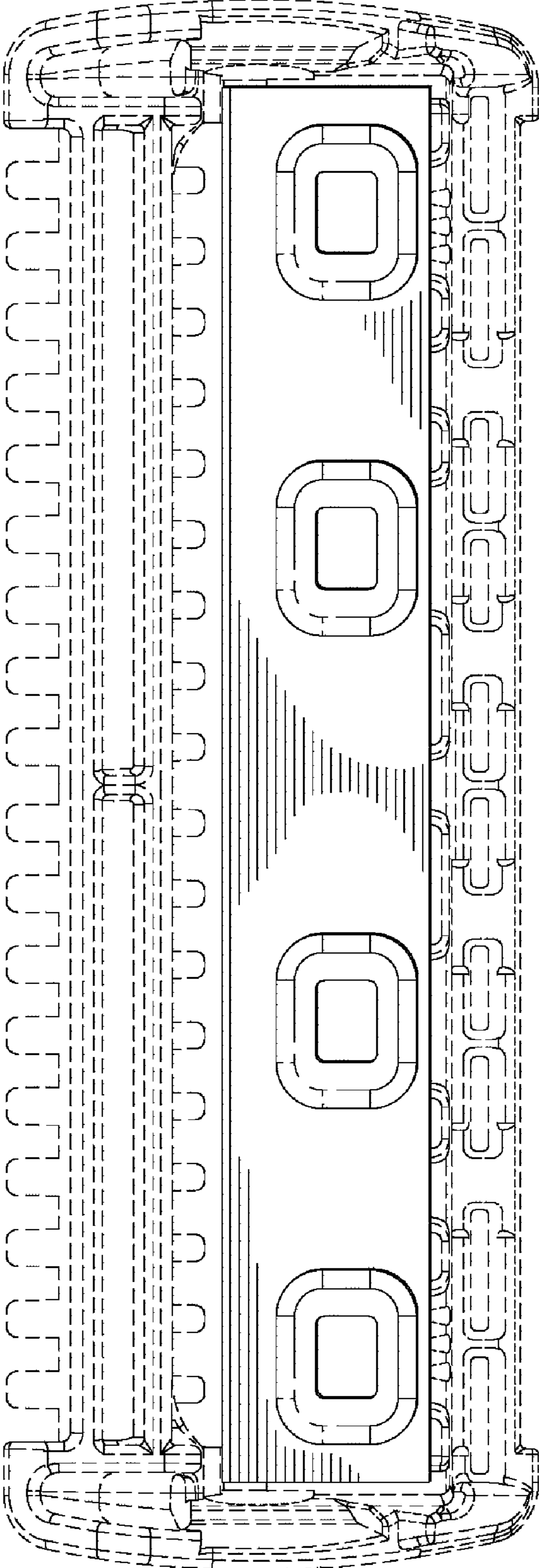

FIG. 7



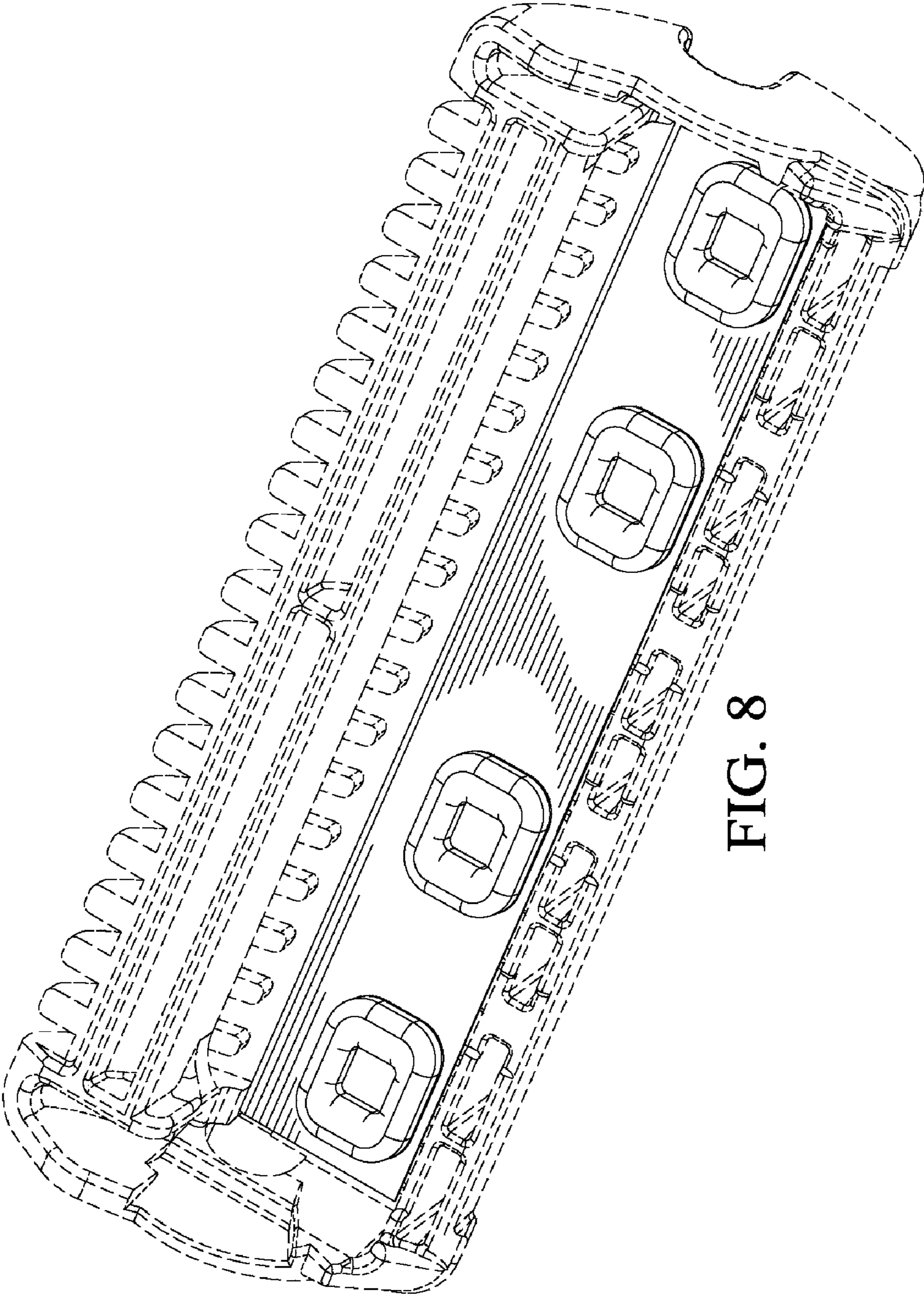

FIG. 8

FIG. 9

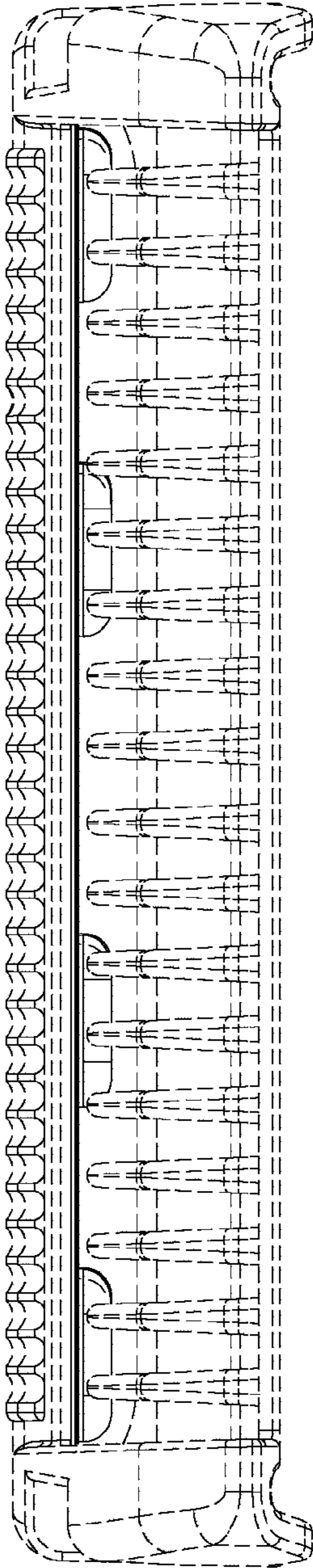

FIG. 10

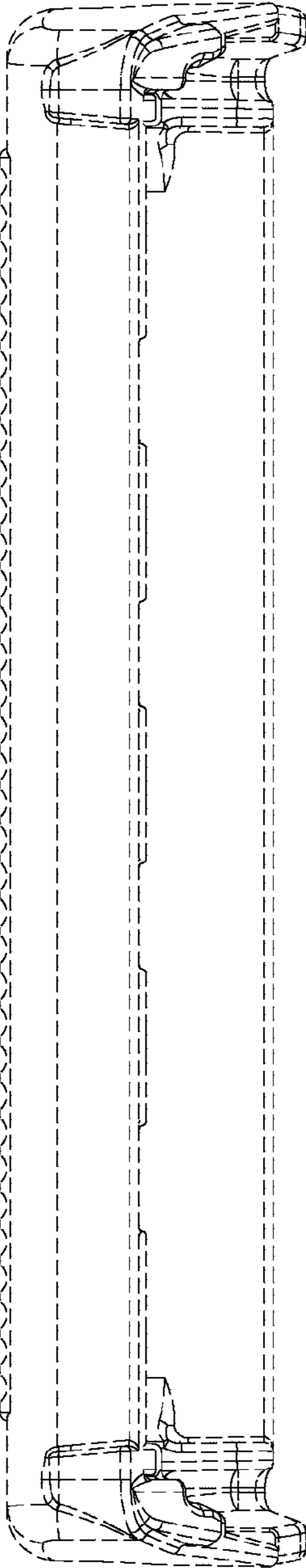

FIG. 12

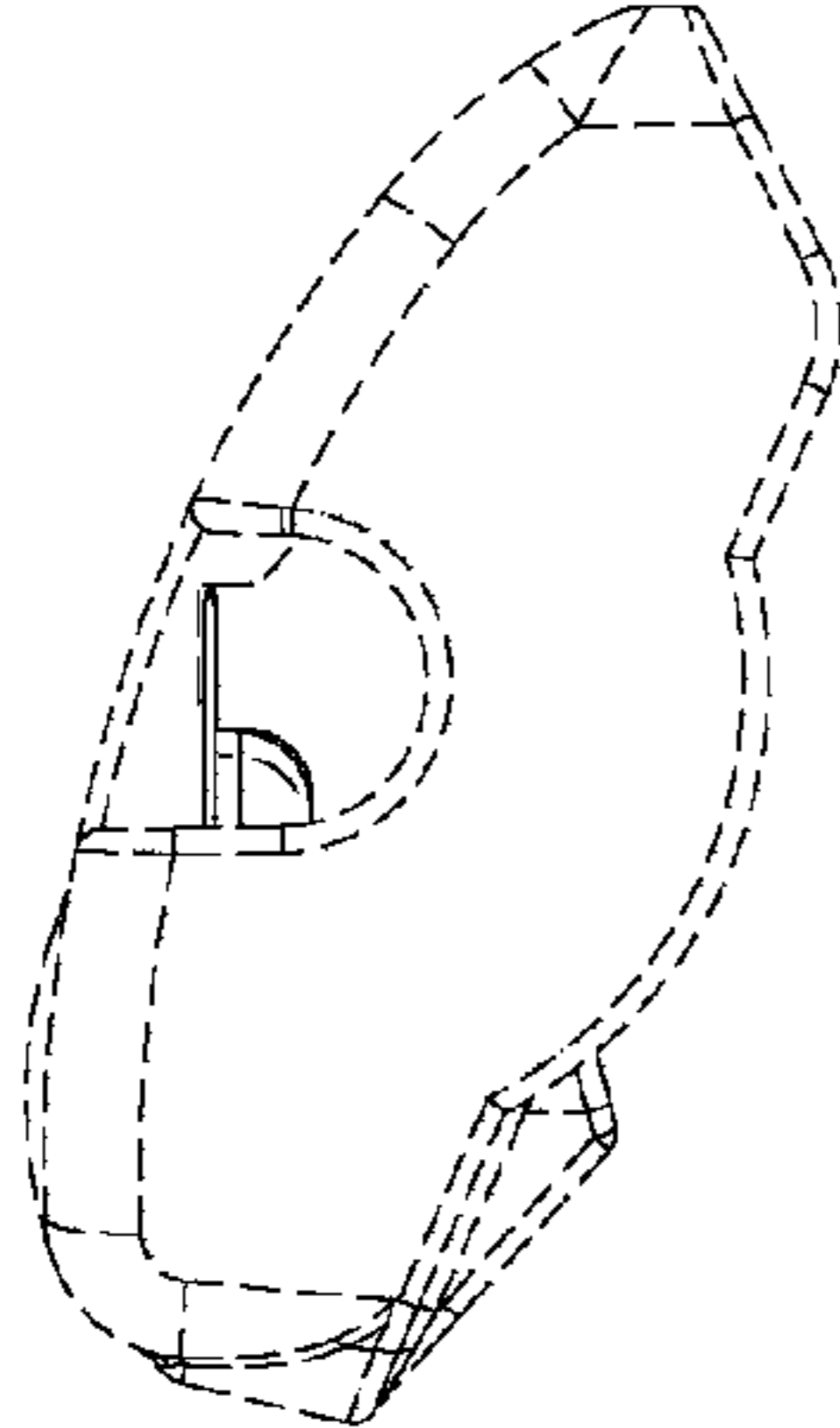

FIG. 11

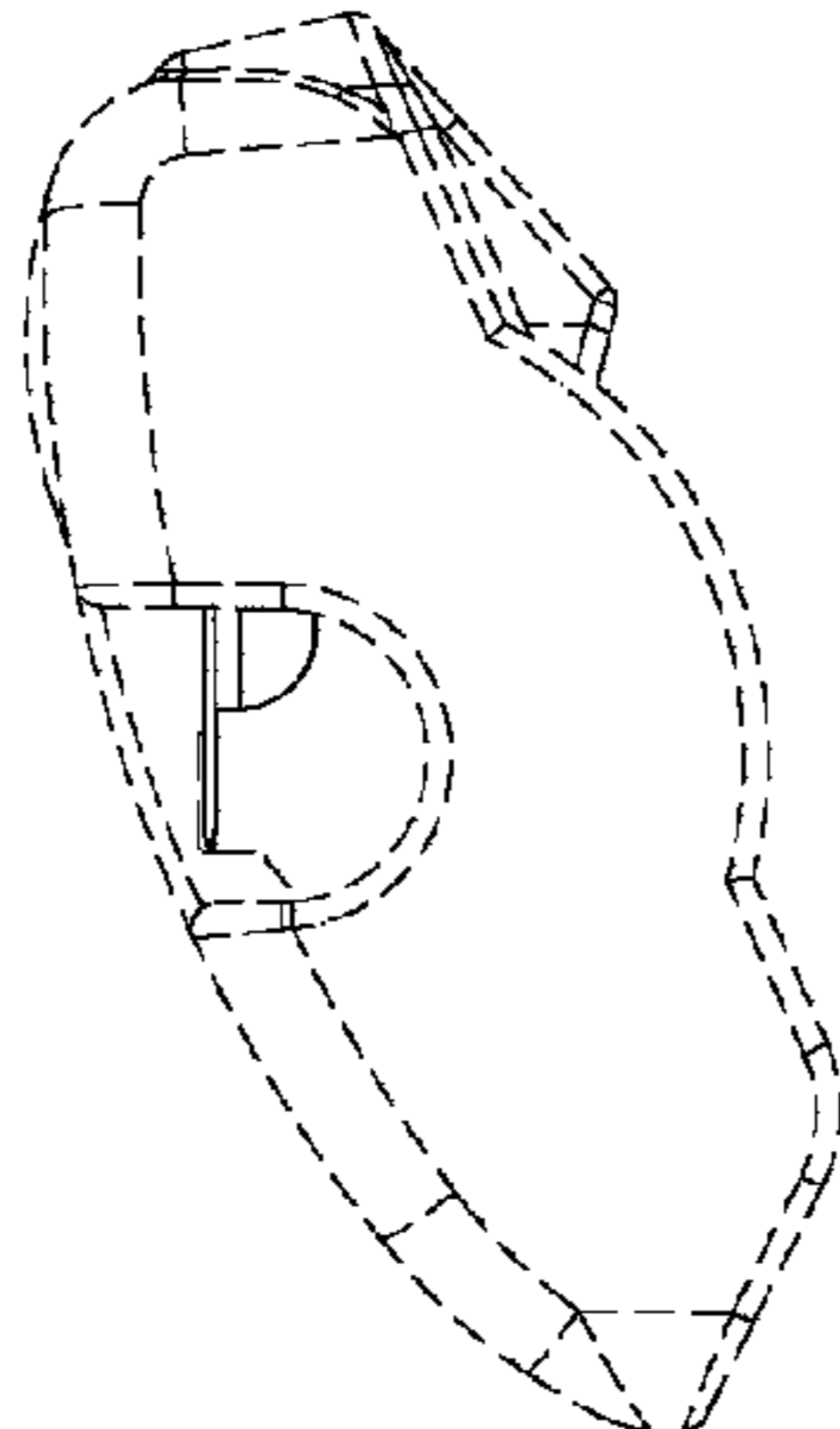

FIG. 13

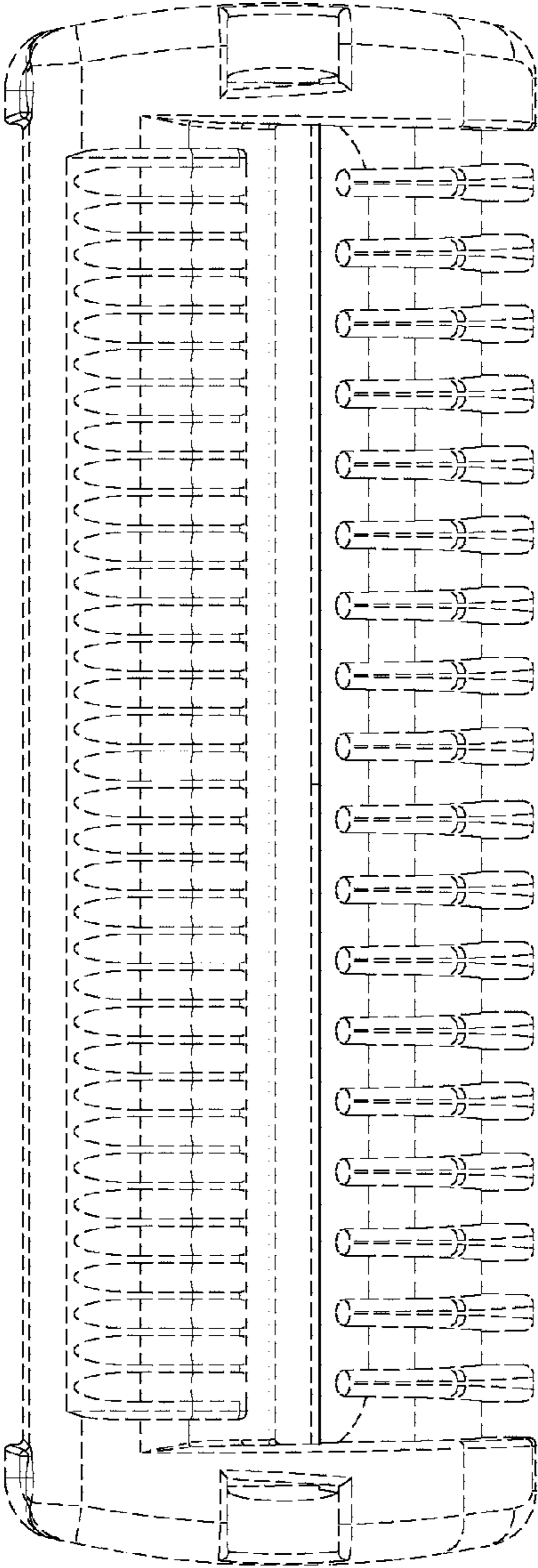

FIG. 14

