



US00D635699S

(12) **United States Design Patent**
Shin et al.

(10) **Patent No.:** **US D635,699 S**
(45) **Date of Patent:** **** Apr. 5, 2011**

(54) **REAR COMBINATION LAMP FOR AUTOMOBILES**

D548,377 S * 8/2007 Markefka D26/28
D560,292 S * 1/2008 Sato D26/28
D570,015 S * 5/2008 Hsu D26/28

(75) Inventors: **Jik-Soo Shin**, Incheon (KR); **Yun-Seok Oh**, Gyeonggi-Do (KR)

* cited by examiner

(73) Assignee: **Kia Motors Corporation**, Seoul (KR)

Primary Examiner — Marcus A Jackson

(**) Term: **14 Years**

(74) *Attorney, Agent, or Firm* — Edwards Angell Palmer & Dodge LLP; Peter F. Corless; Kongsik Kim

(21) Appl. No.: **29/362,604**

(57) **CLAIM**

The ornamental design for a rear combination lamp for automobiles, as shown and described.

(22) Filed: **May 27, 2010**

DESCRIPTION

(30) **Foreign Application Priority Data**

Mar. 30, 2010 (KR) 30-2010-0013794

(51) **LOC (9) Cl.** **26-06**

(52) **U.S. Cl.** **D26/28**

(58) **Field of Classification Search** D26/28-36;
362/459-468, 475-478, 485-487

See application file for complete search history.

FIG. 1 is a perspective view of a rear combination lamp for automobiles according to the present invention.

FIG. 2 is a front view of the rear combination lamp for automobiles of FIG. 1.

FIG. 3 is a rear view of the rear combination lamp for automobiles of FIG. 1.

FIG. 4 is a left side view of the rear combination lamp for automobiles of FIG. 1.

FIG. 5 is a right side view of the rear combination lamp for automobiles of FIG. 1.

FIG. 6 is a top view of the rear combination lamp for automobiles of FIG. 1; and,

FIG. 7 is a bottom view of the rear combination lamp for automobiles of FIG. 1.

(56) **References Cited**

U.S. PATENT DOCUMENTS

D526,427 S * 8/2006 Morioka D26/28
D528,232 S * 9/2006 Nakahara D26/28
D528,680 S * 9/2006 Oda D26/28
D528,684 S * 9/2006 Kato et al. D26/28

1 Claim, 7 Drawing Sheets

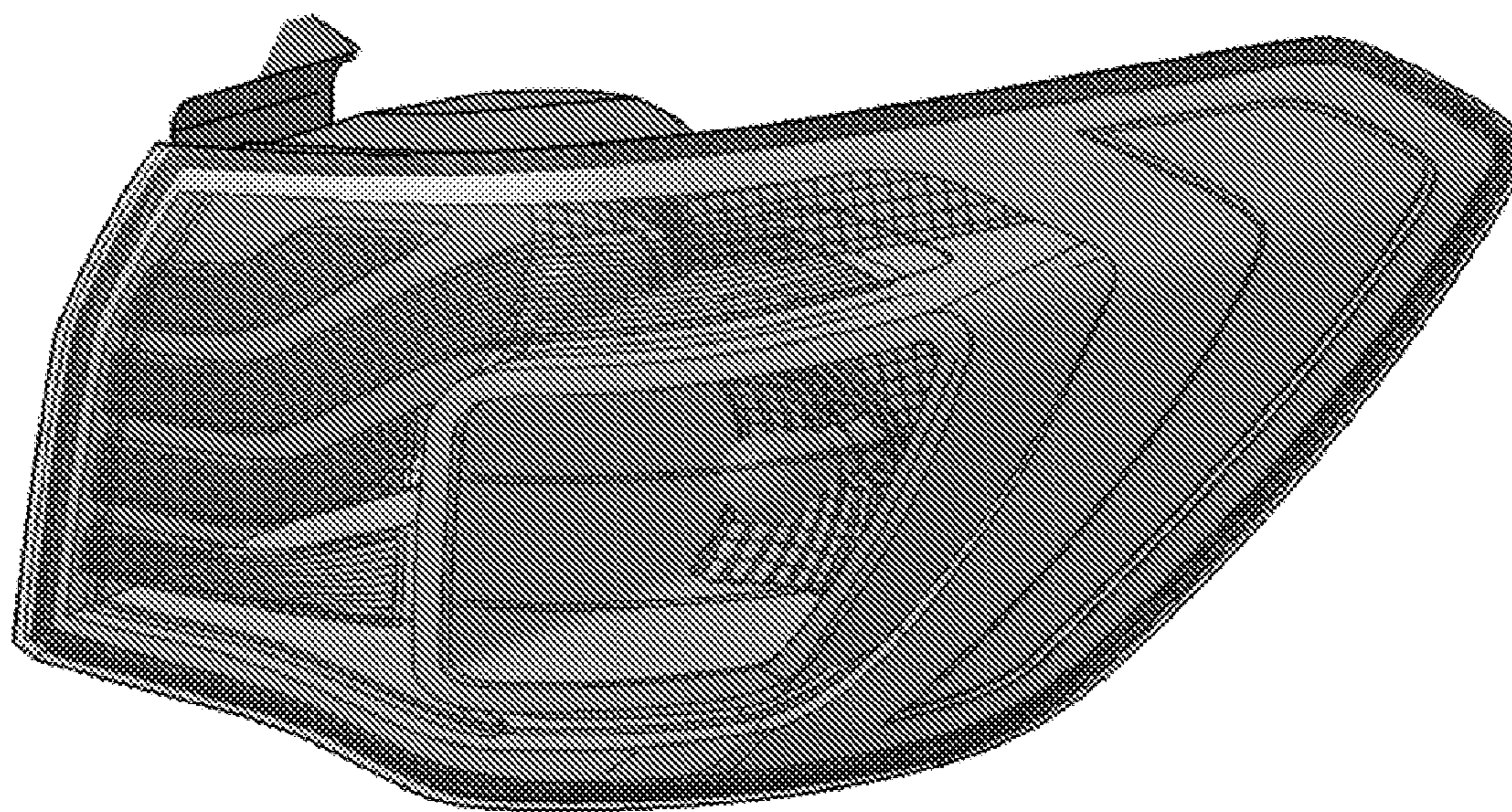

FIG. 1

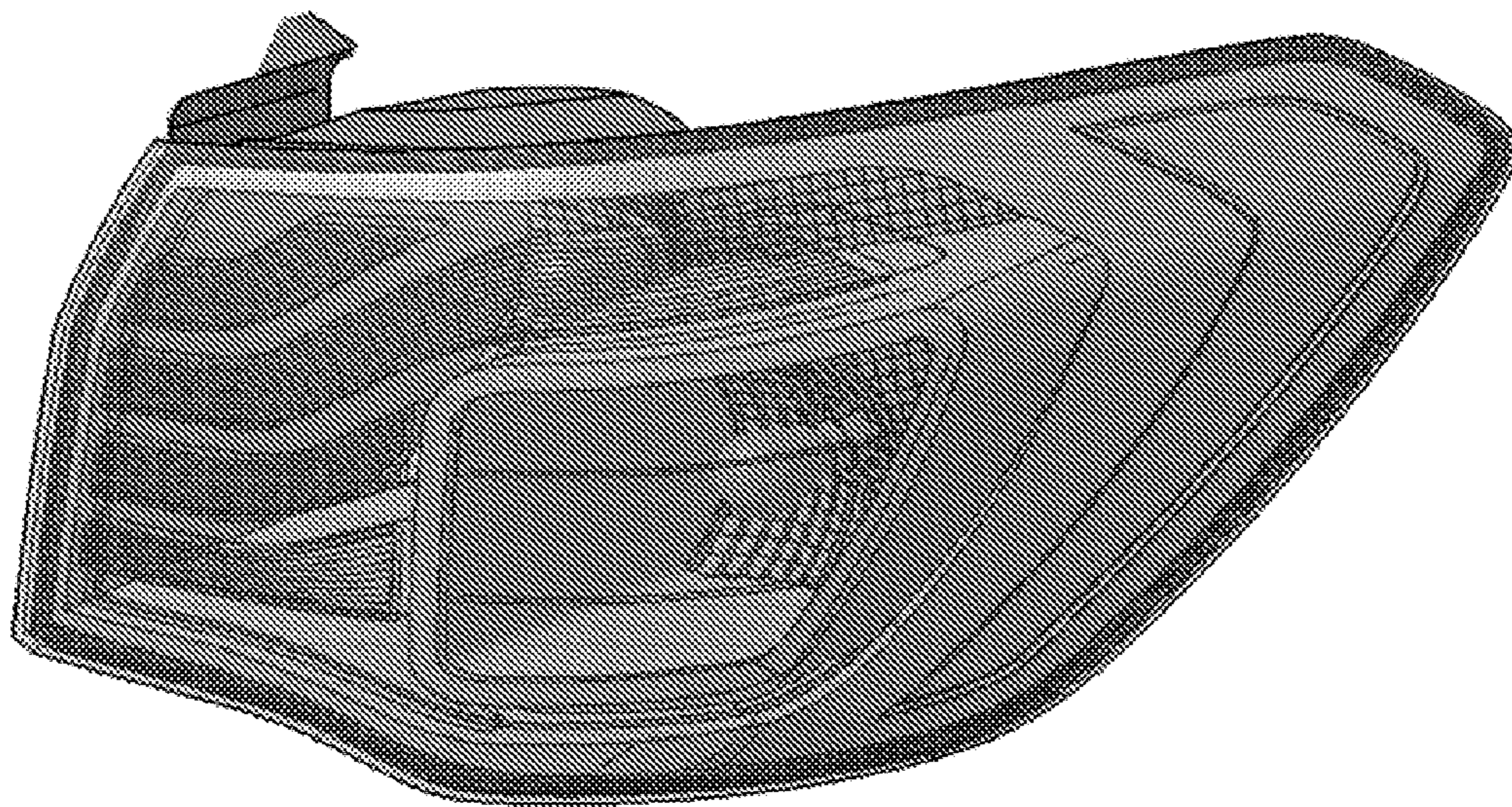

FIG. 2

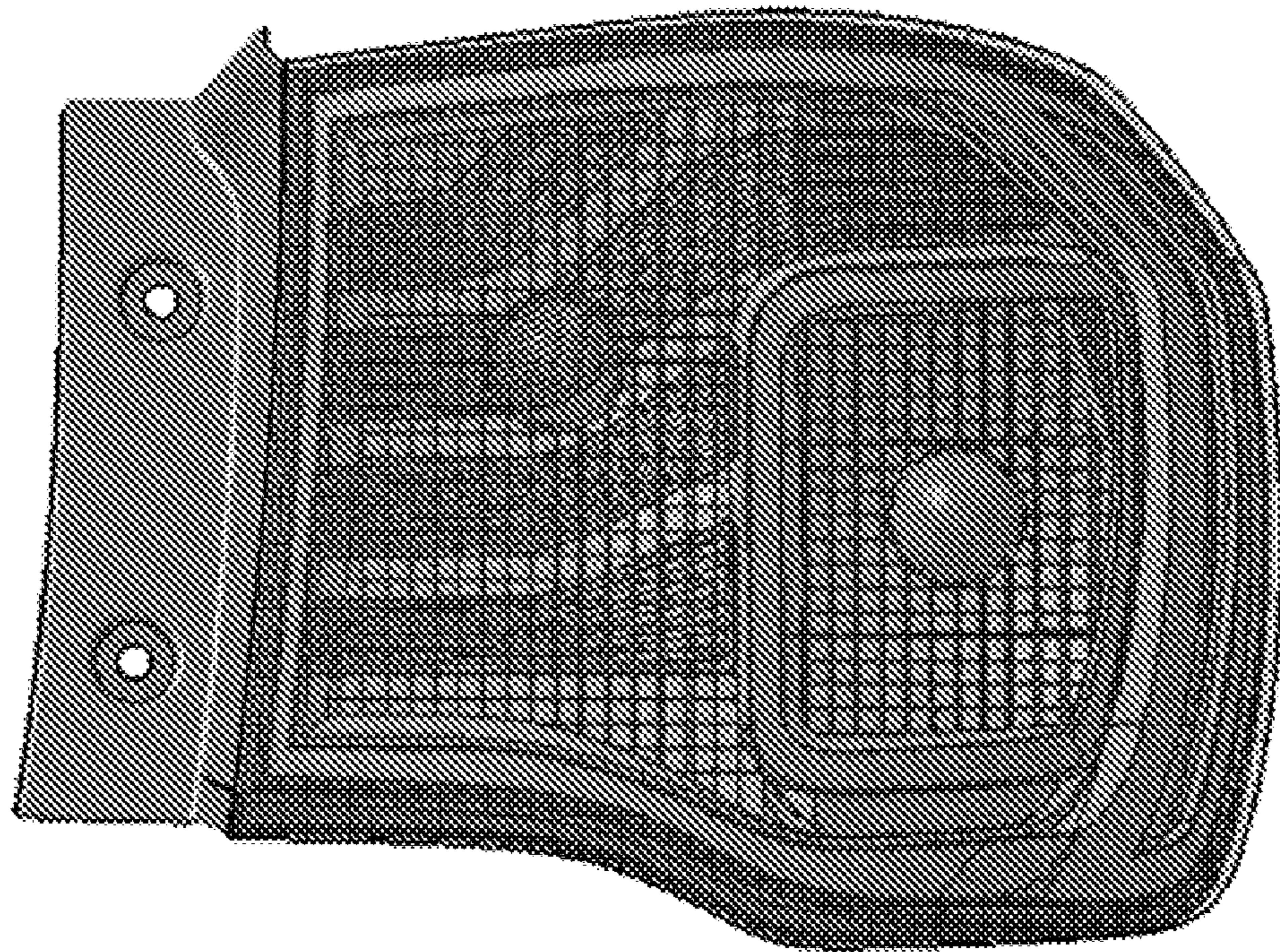

FIG. 3

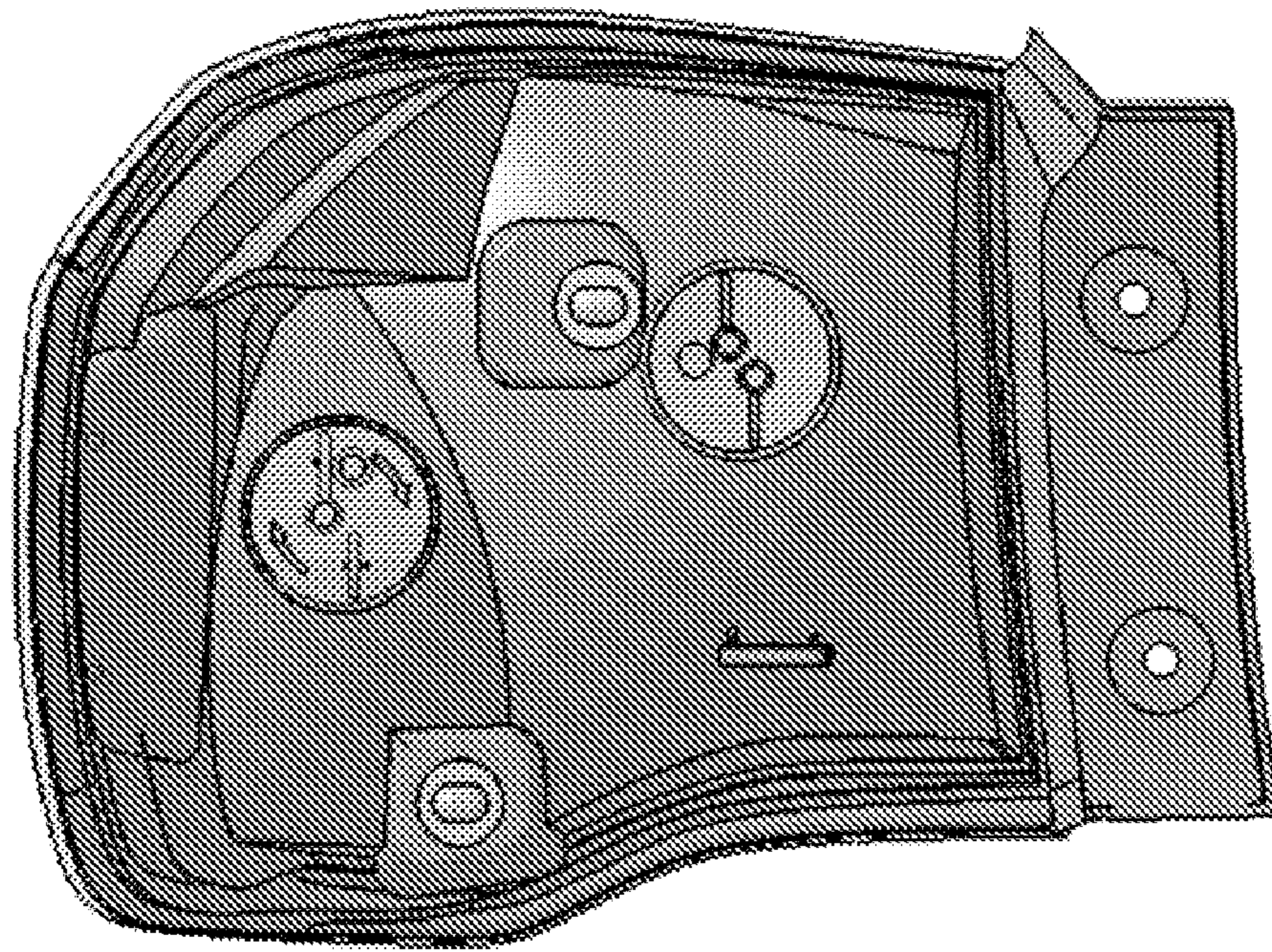

FIG. 4

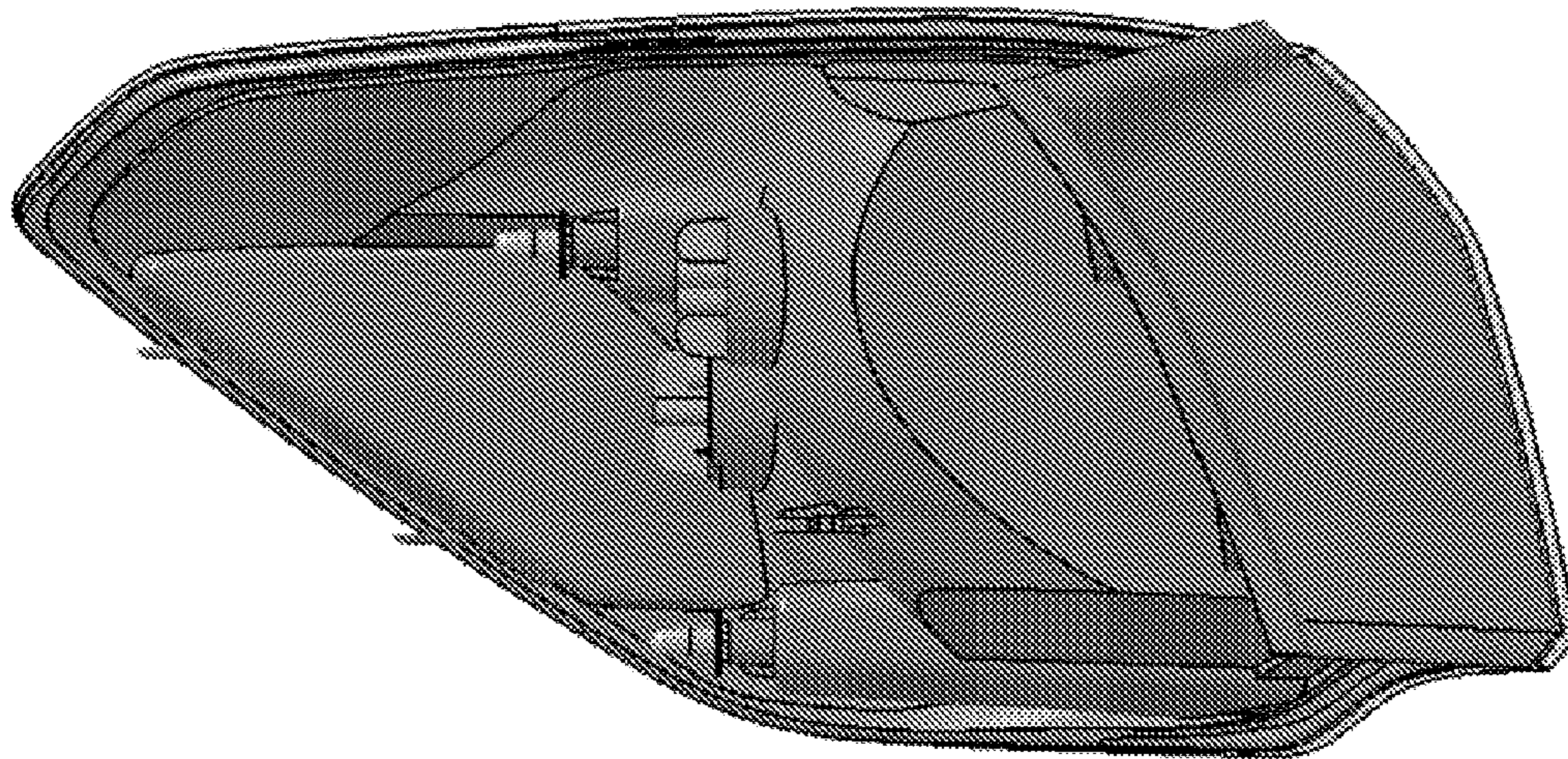

FIG. 5

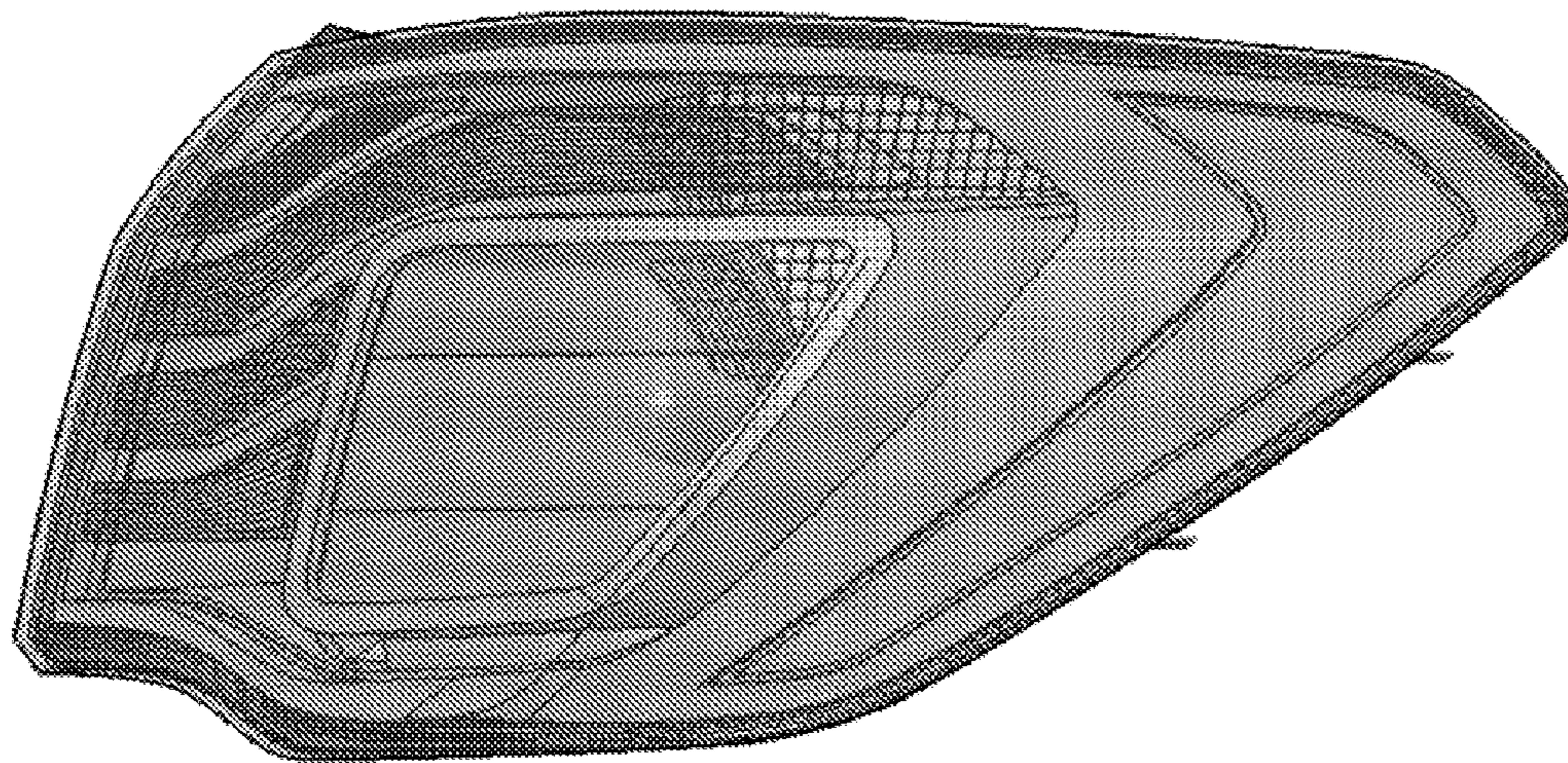

FIG. 6

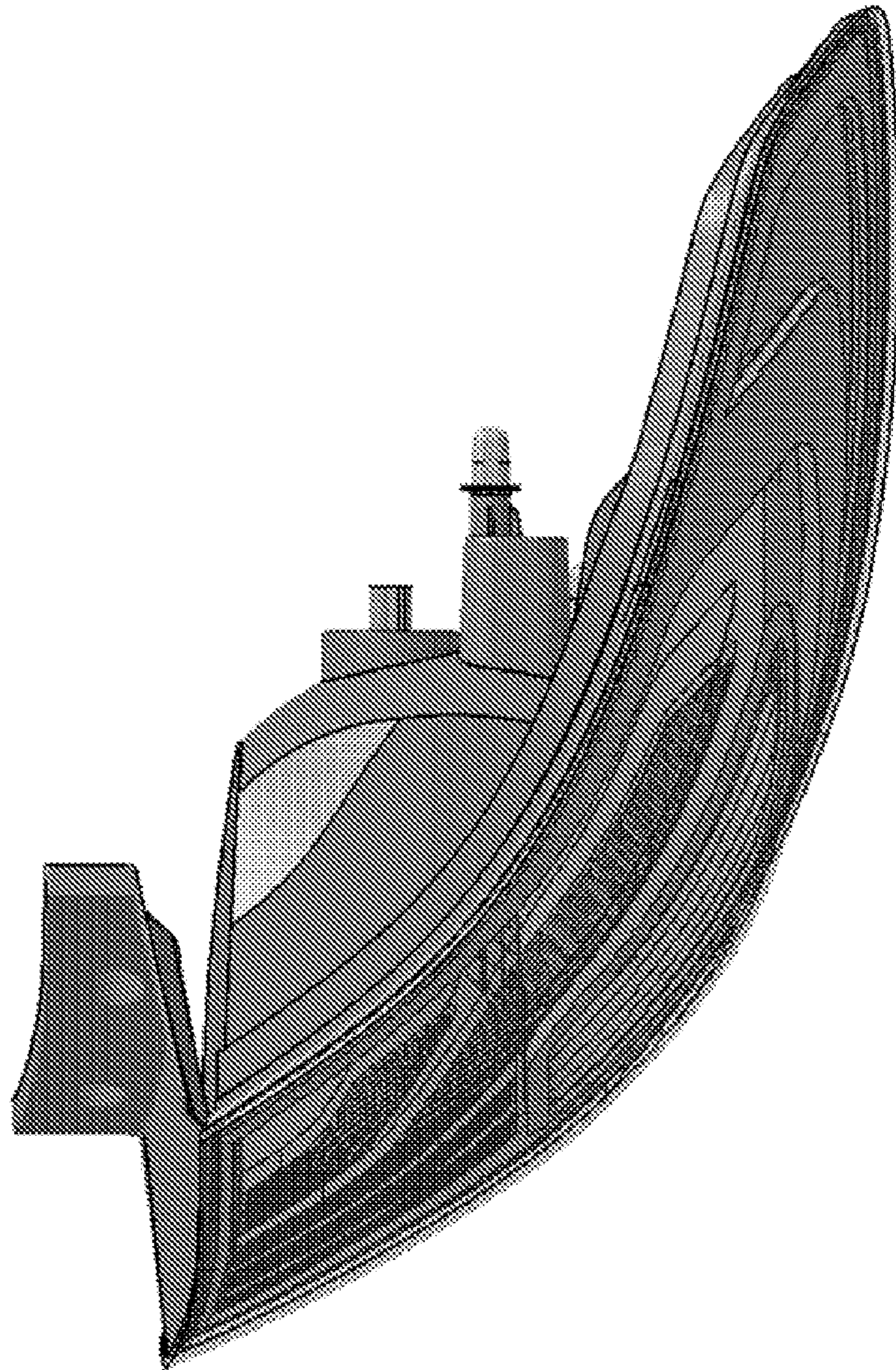

FIG. 7

