



US00D635686S

(12) **United States Design Patent**  
**Tucker et al.**

(10) **Patent No.:** **US D635,686 S**

(45) **Date of Patent:** **\*\* Apr. 5, 2011**

(54) **PHOTOTHERAPY DEVICE**

(75) Inventors: **Gavin Tucker**, Irvine, CA (US);  
**Nicholas Brox**, Laguna Beach, CA (US);  
**Jeffrey Braile**, Boca Raton, FL (US);  
**Morgan Pepitone**, Newport Beach, CA (US)

(73) Assignee: **APIRA Science, Inc.**, Newport Beach, CA (US)

(\*\*) Term: **14 Years**

(21) Appl. No.: **29/370,778**

(22) Filed: **Sep. 3, 2010**

(51) **LOC (9) Cl.** ..... **28-03**

(52) **U.S. Cl.** ..... **D24/209**

(58) **Field of Classification Search** ..... D24/210,  
D24/209, 200, 158, 176, 191; 362/555, 545,  
362/800, 294, 249, 267; D14/205, 223; D29/102,  
D29/103, 105, 106, 112; 2/423; D26/29,  
D26/37, 39, 41, 104; 606/2-4, 16, 131; 607/88-95;  
433/29; 601/15, 12, DIG. 5  
See application file for complete search history.

(56) **References Cited**

**U.S. PATENT DOCUMENTS**

3,197,785 A \* 8/1965 Simpson et al. .... 2/423  
3,435,460 A \* 4/1969 Grant ..... D29/106

D244,491 S \* 5/1977 Csiki et al. .... D29/105  
D263,954 S \* 4/1982 Stratman ..... D24/210  
D328,497 S \* 8/1992 Morrison et al. .... D24/200  
D347,711 S \* 6/1994 Egger ..... D29/102  
D361,411 S \* 8/1995 Ho ..... D29/102  
5,743,621 A \* 4/1998 Mantha et al. .... 362/800  
D427,382 S \* 6/2000 Leight et al. .... D29/112  
6,267,721 B1 \* 7/2001 Welles ..... 607/88  
D482,500 S \* 11/2003 Ho ..... D29/102  
6,754,911 B1 \* 6/2004 Howell ..... 2/423  
D625,020 S \* 10/2010 Lauzis et al. .... D24/200

\* cited by examiner

*Primary Examiner* — David G Muller

(74) *Attorney, Agent, or Firm* — Robert M. Downey, P.A.

(57) **CLAIM**

The ornamental design for a phototherapy device, as shown and described.

**DESCRIPTION**

FIG. 1 is a front, bottom perspective view of a phototherapy device showing our new design;  
FIG. 2 is a front elevational view thereof;  
FIG. 3 is a rear elevational view thereof;  
FIG. 4 a left side elevational view thereof;  
FIG. 5 is a right side elevational view thereof;  
FIG. 6 is a top plan view thereof; and,  
FIG. 7 is a bottom plan view thereof.

**1 Claim, 4 Drawing Sheets**

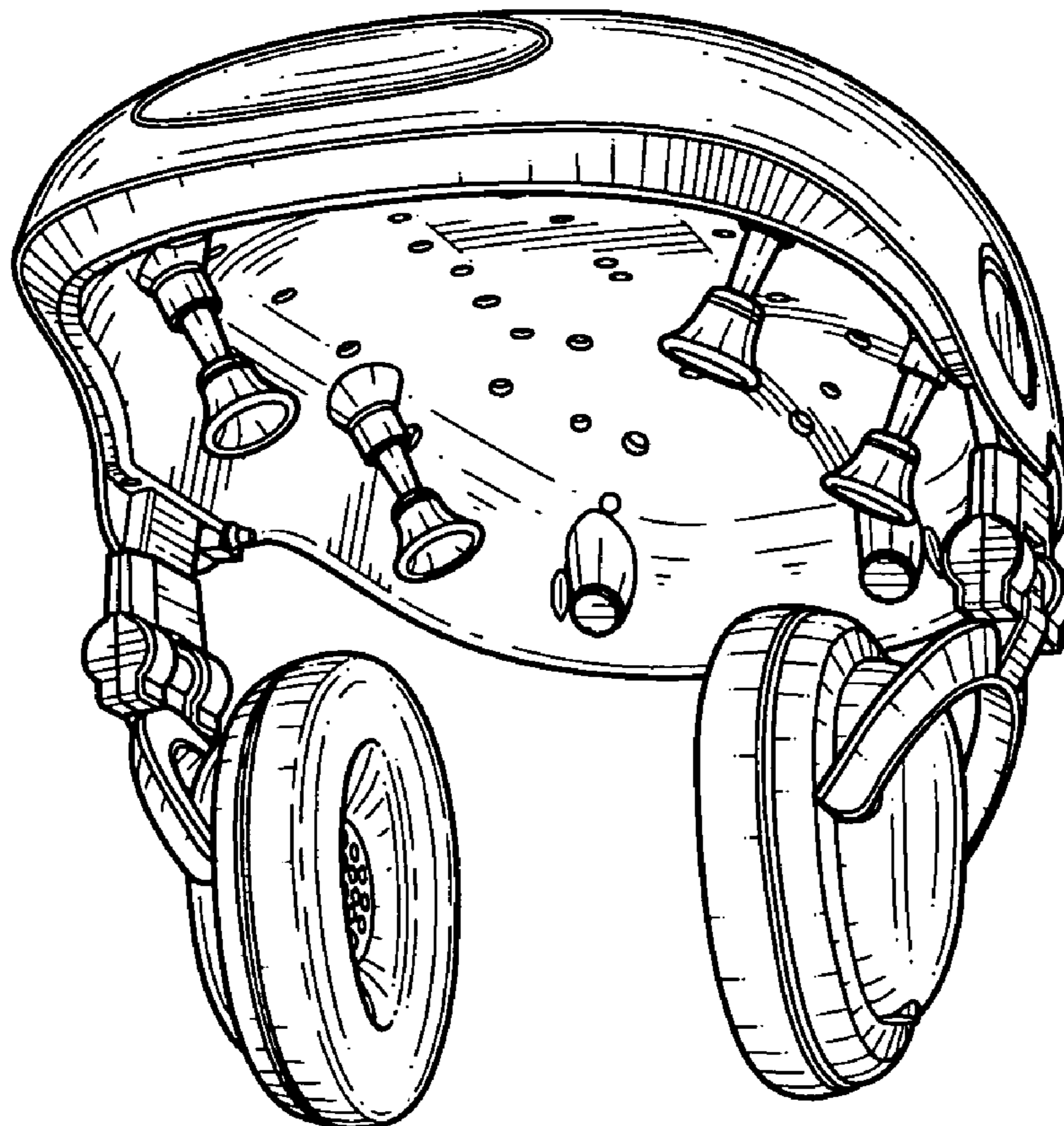

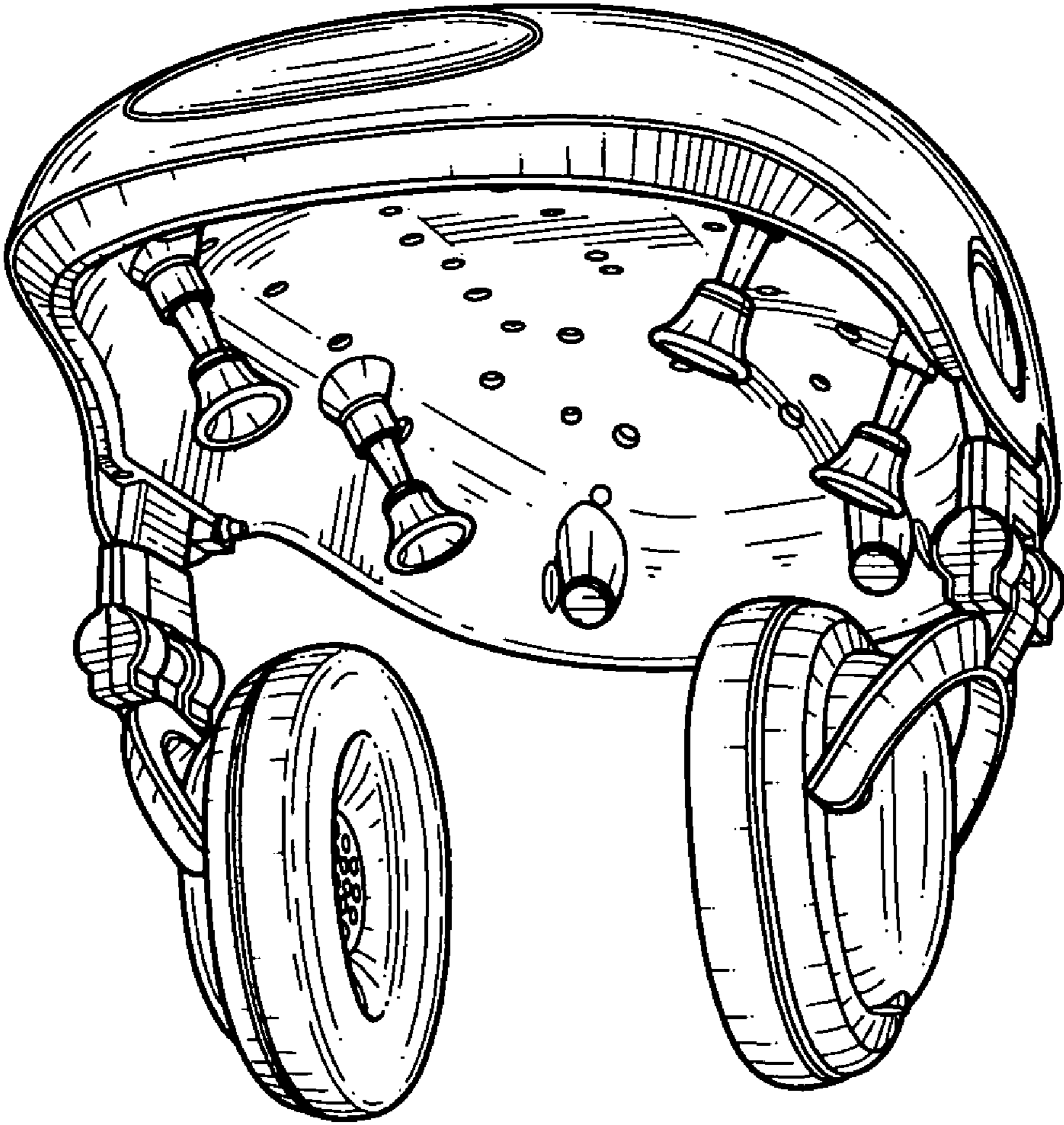

FIG. 1

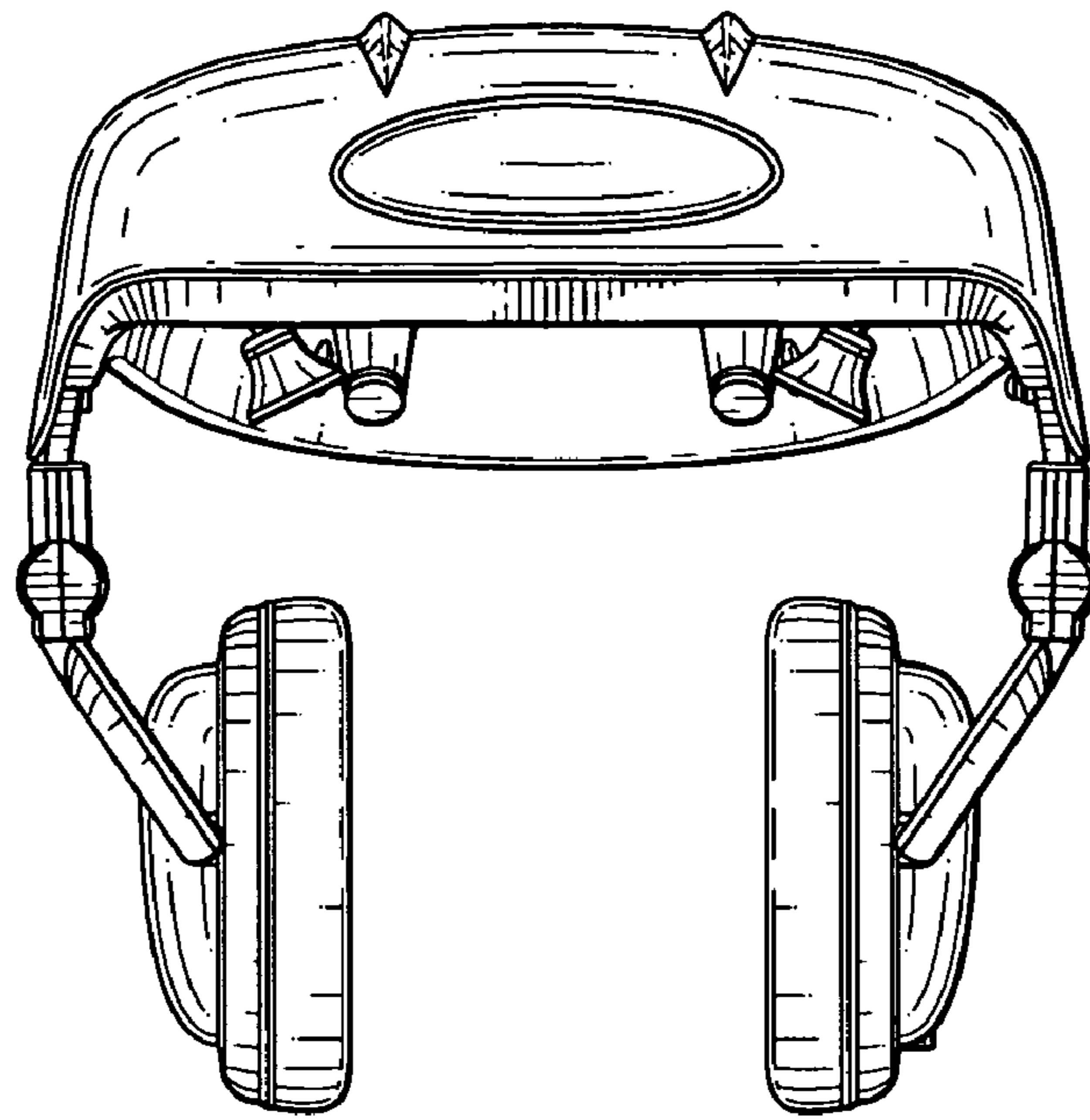

FIG. 2

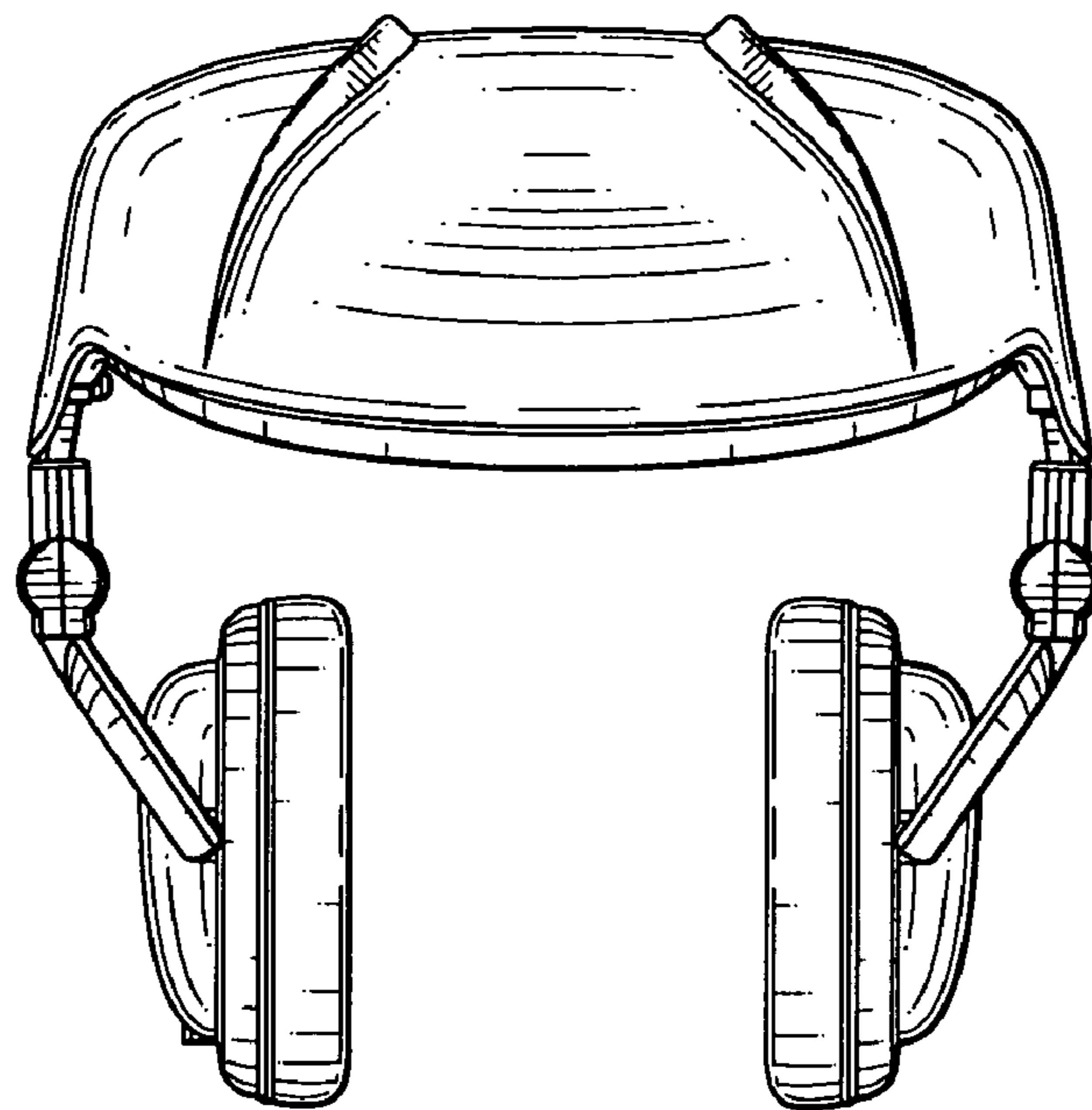

FIG. 3

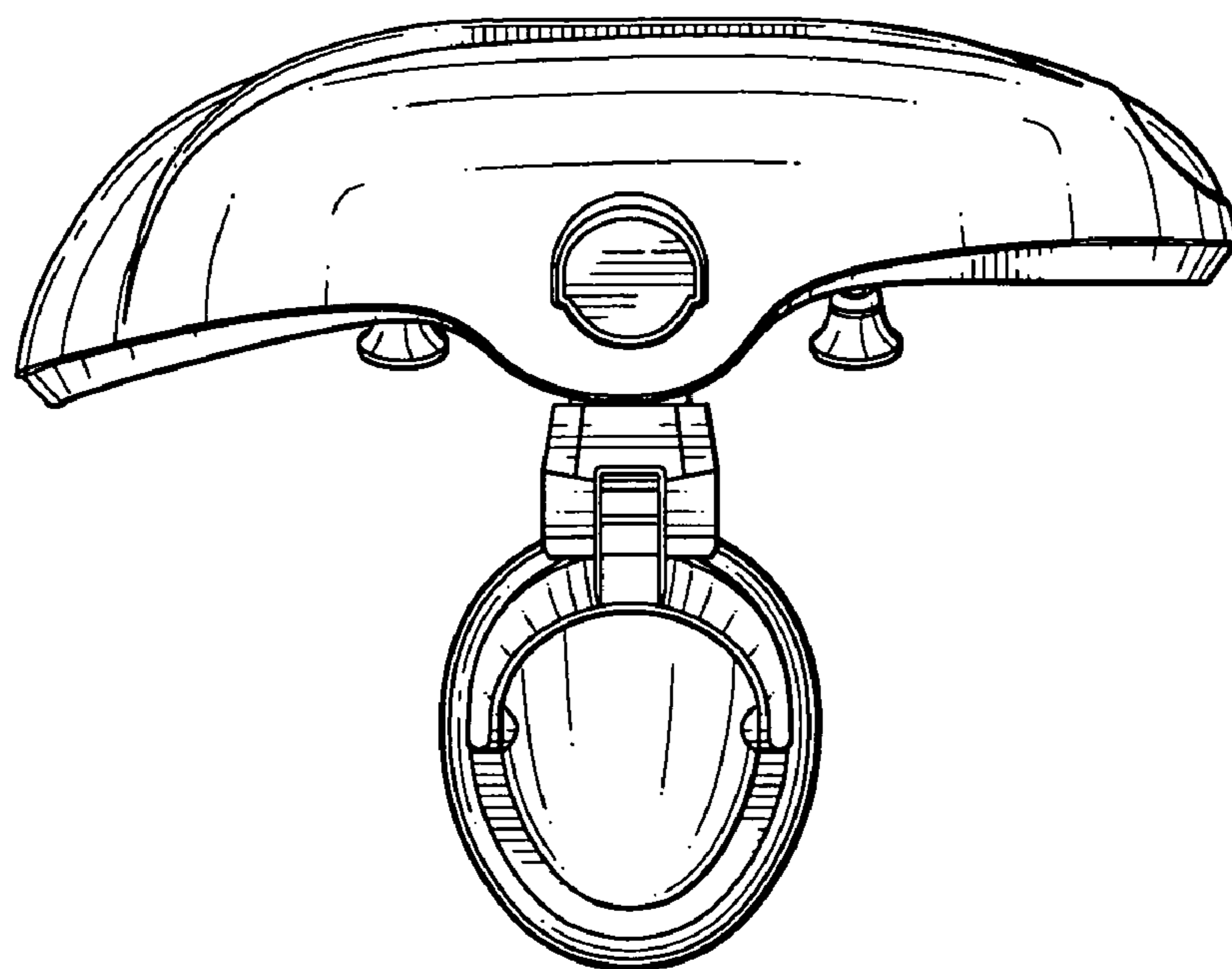

FIG. 4

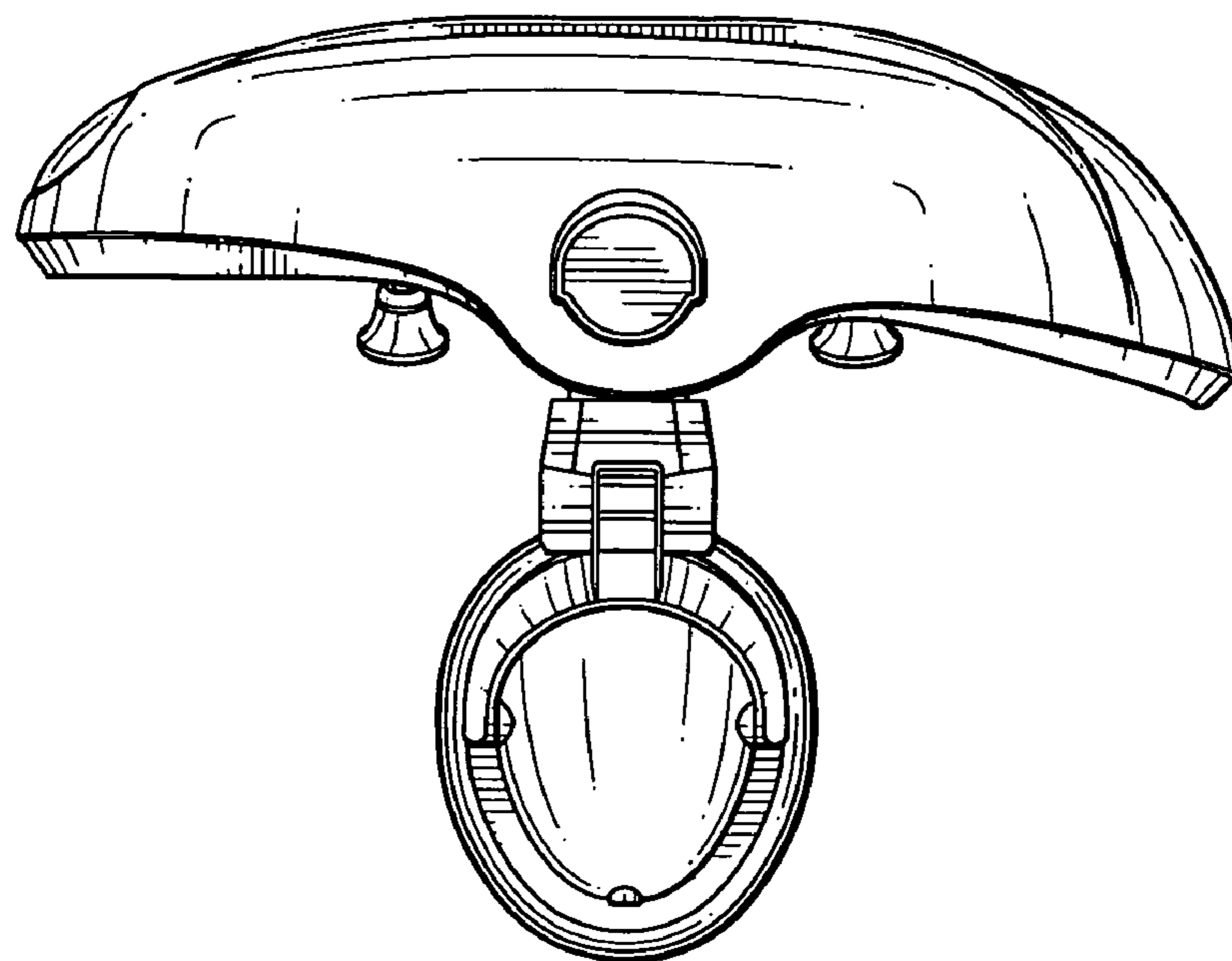

FIG. 5



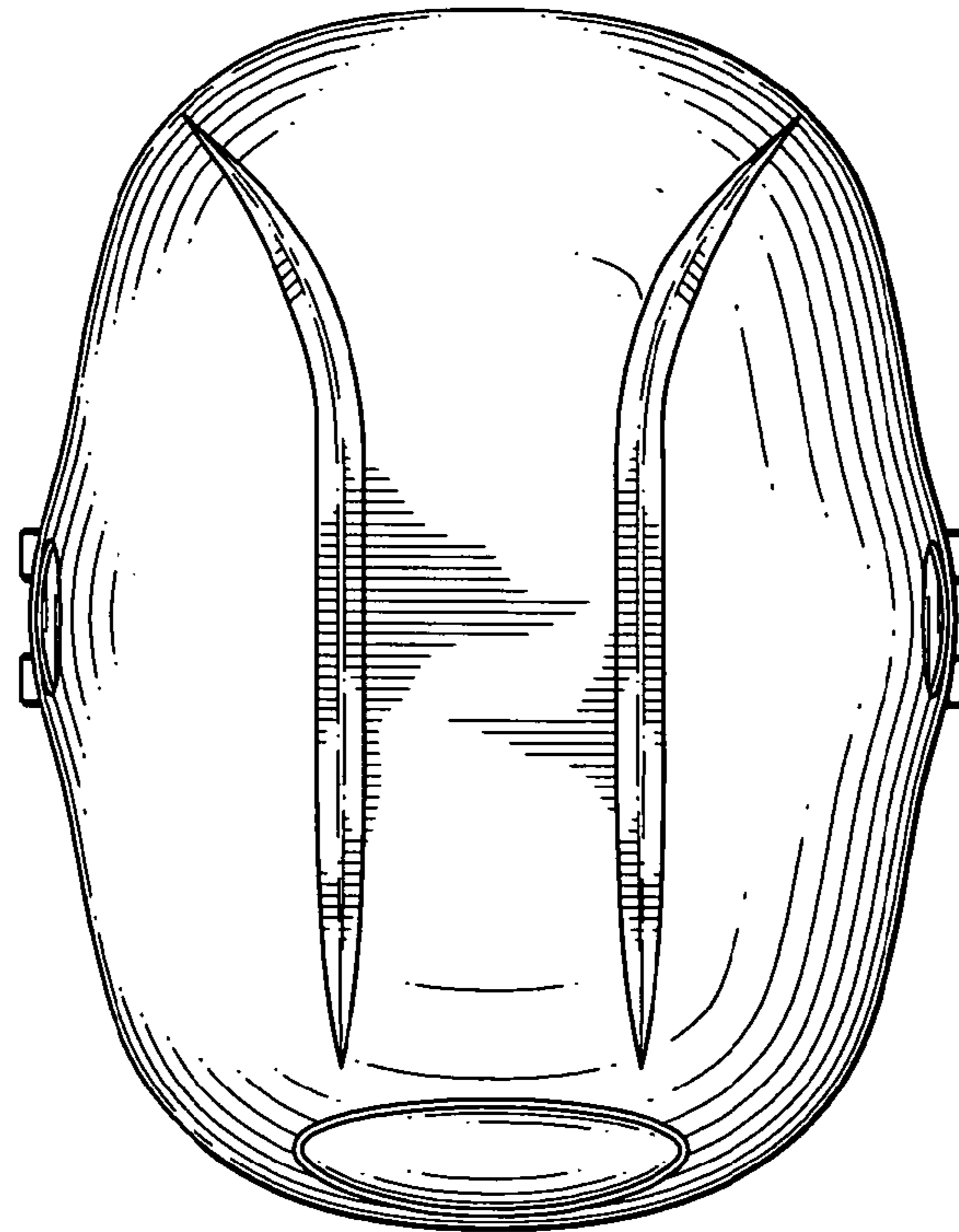

FIG. 6

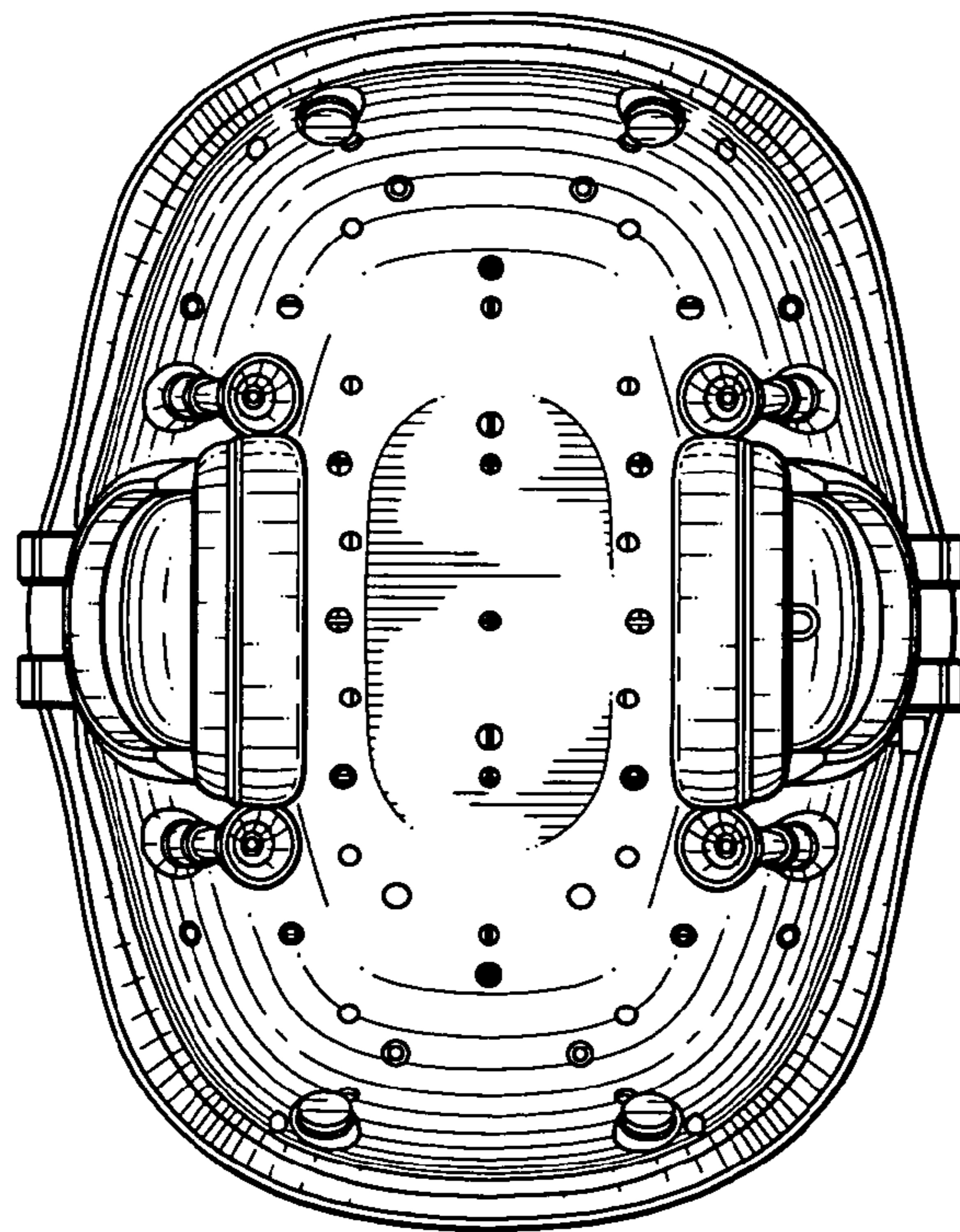

FIG. 7