

US00D635646S

(12) **United States Design Patent**
Sedwick

(10) **Patent No.:** **US D635,646 S**
(45) **Date of Patent:** **** Apr. 5, 2011**

(54) **FAUCET BODY**

(75) Inventor: **Jennifer P. Sedwick**, Lakewood, OH (US)

(73) Assignee: **Moen Incorporated**, North Olmsted, OH (US)

(**) Term: **14 Years**

(21) Appl. No.: **29/378,204**

(22) Filed: **Nov. 1, 2010**

Related U.S. Application Data

(62) Division of application No. 29/354,735, filed on Jan. 28, 2010, now Pat. No. Des. 626,629.

(51) **LOC (9) Cl.** **23-01**

(52) **U.S. Cl.** **D23/238**

(58) **Field of Classification Search** D23/238,
D23/241-243, 250, 252, 255, 257; 4/675-678;
137/801

See application file for complete search history.

(56) **References Cited**

U.S. PATENT DOCUMENTS

D301,162 S	5/1989	Oberdorfer
D324,095 S	2/1992	Grohe
D350,389 S	9/1994	Gottwald
D351,017 S	9/1994	Gottwald
D353,650 S	12/1994	Haug et al.
D354,336 S	1/1995	Delabie et al.
D355,706 S	2/1995	Chretien
D364,214 S	11/1995	Lobermeier
D367,919 S	3/1996	Lobermeier
D368,303 S	3/1996	Lobermeier
D380,811 S	7/1997	Gottwald
D390,918 S	2/1998	Lobermeier
D397,205 S	8/1998	Kergoet
D397,768 S	9/1998	Delabie et al.
D399,302 S	10/1998	Bertoli
D400,645 S	11/1998	Kergoet
D403,745 S	1/1999	Lobermeier

D410,066 S	5/1999	Kergoet	
D410,277 S	5/1999	Lobermeier	
D413,375 S	8/1999	Meda	
D413,376 S	8/1999	Meda	
D426,287 S	6/2000	Fiegl et al.	
D435,088 S	12/2000	Fleischmann	
D441,426 S	5/2001	Lim	
D447,219 S	8/2001	Donath, Jr. et al.	
6,314,593 B1	11/2001	Mantel	
6,363,549 B2	4/2002	Humpert et al.	
D465,556 S	11/2002	Ouyoung	
D474,260 S *	5/2003	Marshall D23/238
D474,261 S	5/2003	Schonherr et al.	
D477,653 S	7/2003	Neufeld et al.	
D486,561 S	2/2004	Spangler	
D487,134 S	2/2004	Blattner	
D492,010 S	6/2004	Sutopo	
D524,417 S	7/2006	Kulig	
D530,397 S *	10/2006	Buschmann D23/238
D550,812 S	9/2007	Haug et al.	
D585,524 S	1/2009	Schoenherr et al.	

* cited by examiner

Primary Examiner — Robert A Delehanty

(74) *Attorney, Agent, or Firm* — Calfee, Halter & Griswold LLP

(57) **CLAIM**

The ornamental design for a faucet body, as shown and described.

DESCRIPTION

FIG. 1 is a perspective view of a faucet body of the new design;

FIG. 2 is a front elevational view of the faucet body of FIG. 1;

FIG. 3 is a rear elevational view of the faucet body of FIG. 1;

FIG. 4 is a left side elevational view of the faucet body of FIG. 1,

the right side elevational view being a mirror image thereof;

FIG. 5 is a top plan view of the faucet body of FIG. 1; and,

FIG. 6 is a bottom plan view of the faucet body of FIG. 1.

The portions of the Figures shown in broken lines are not part of the claimed design and are for illustration only.

1 Claim, 4 Drawing Sheets

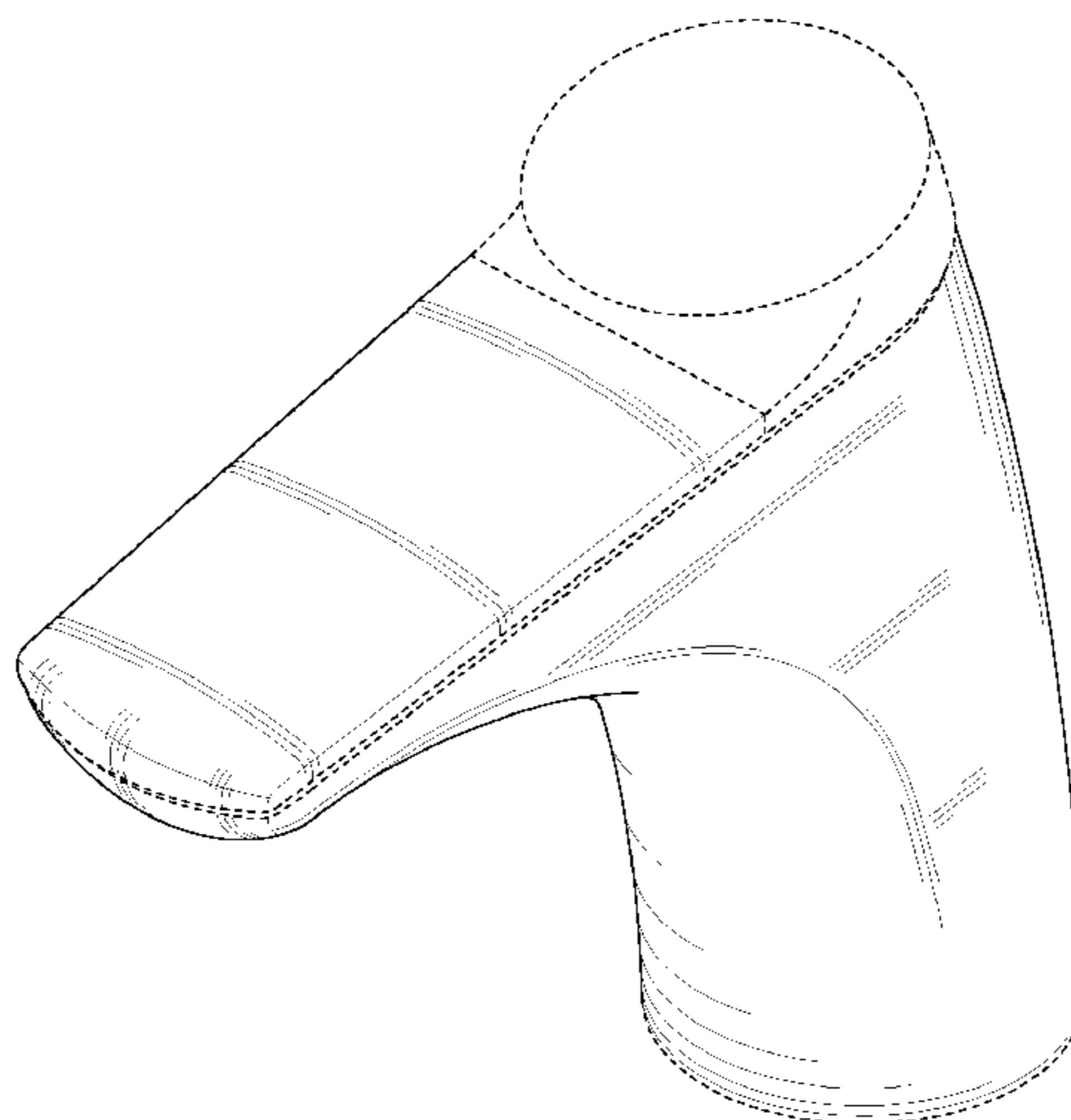

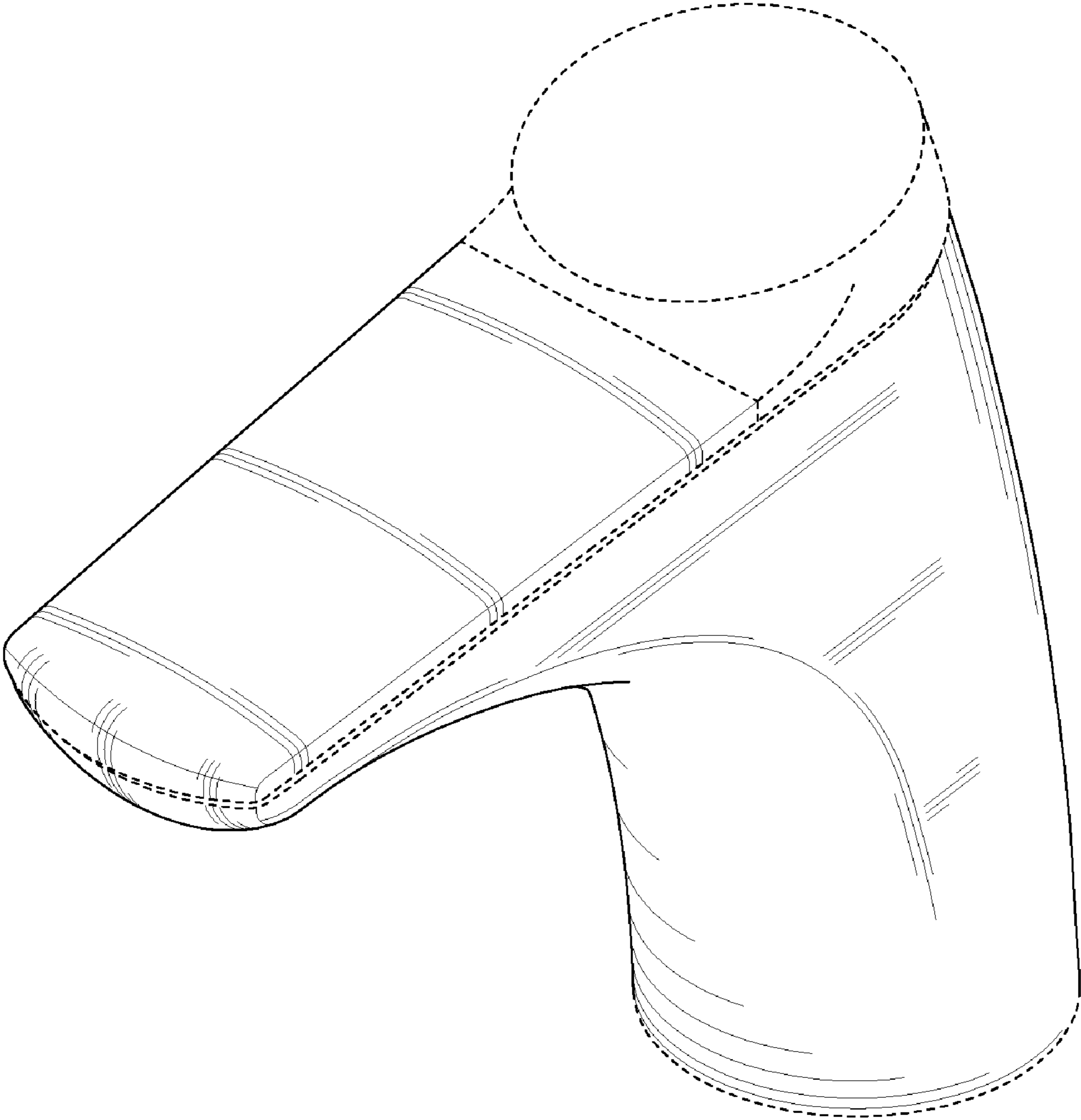

FIG. 1

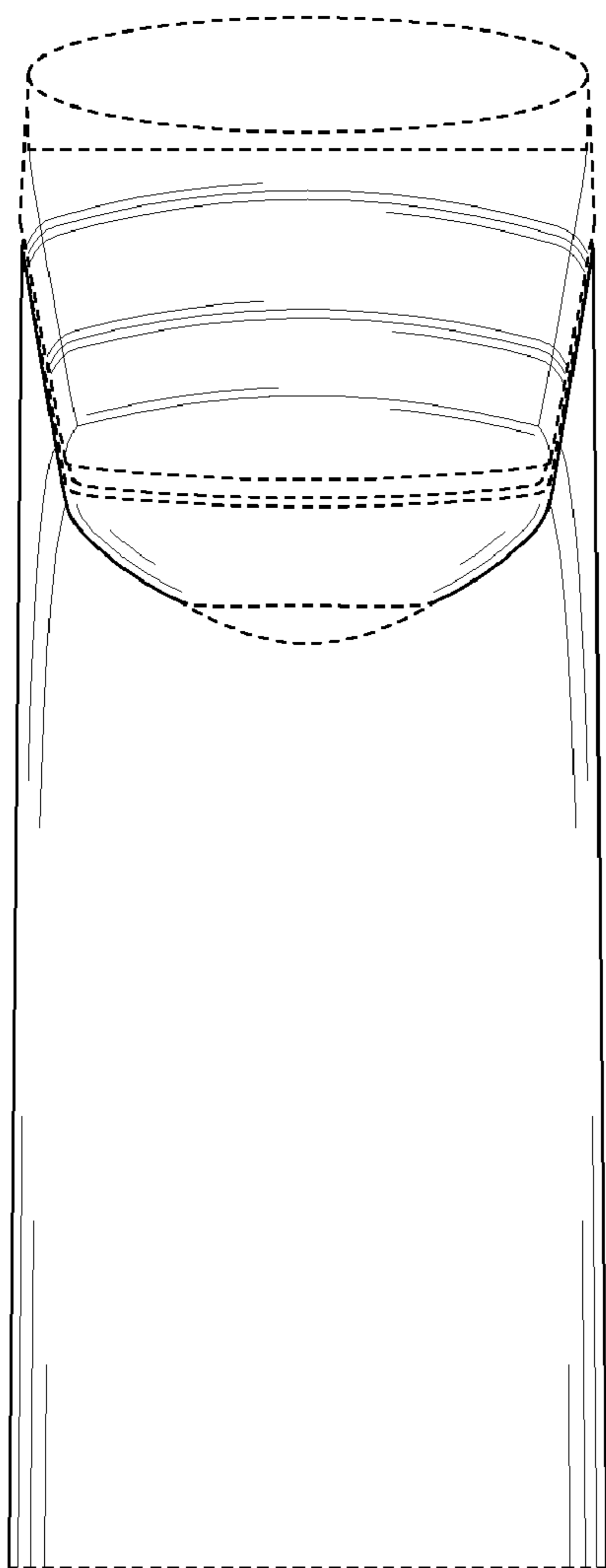

FIG. 2

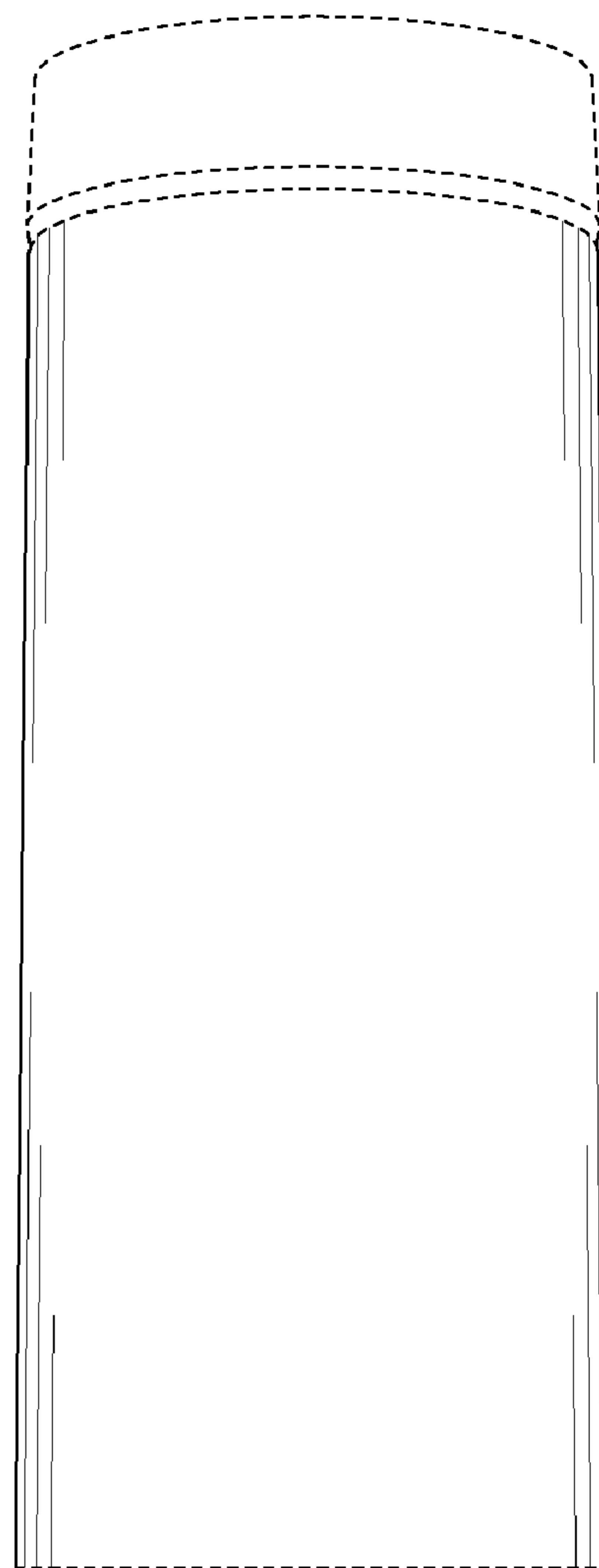

FIG. 3

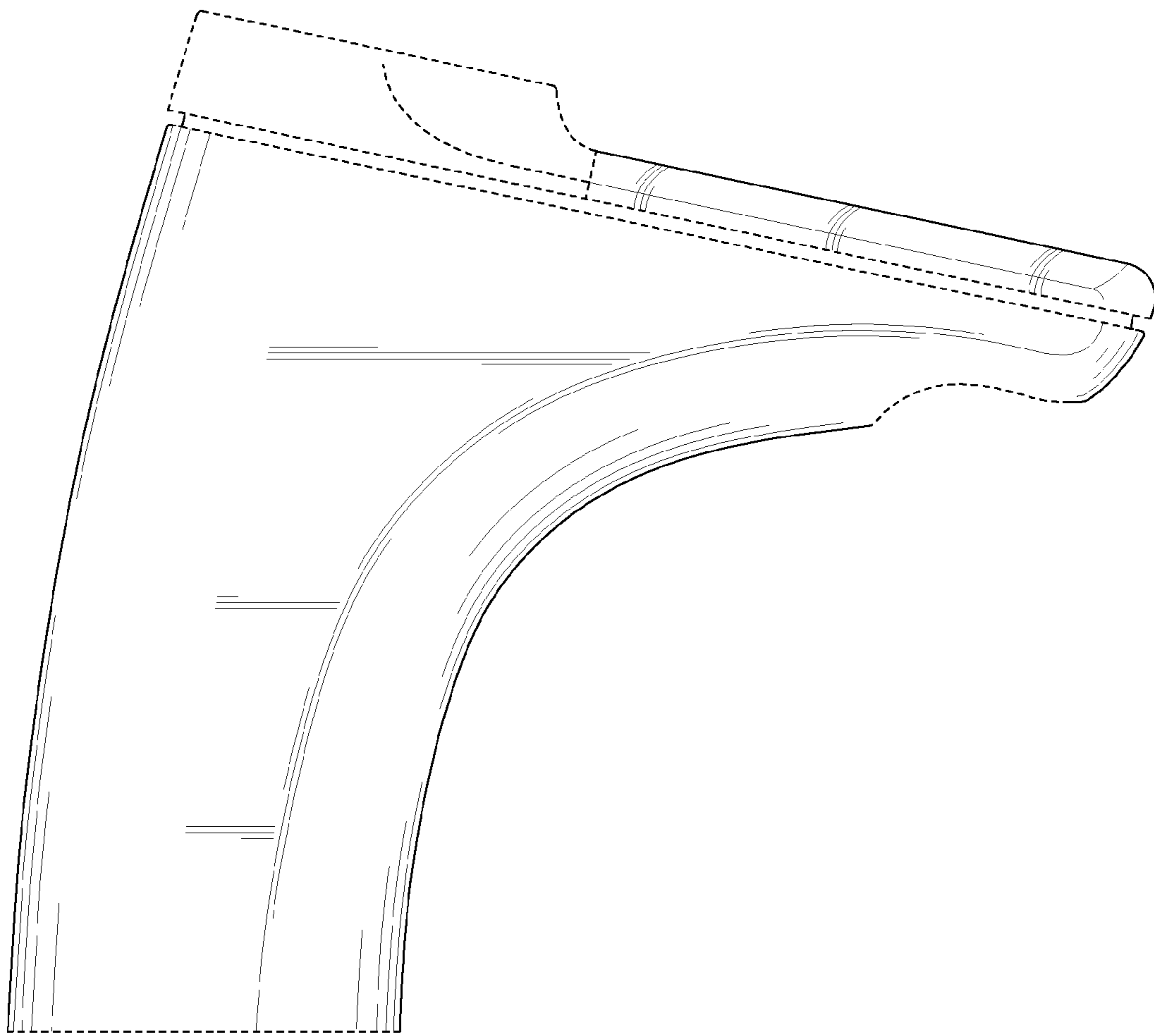

FIG. 4

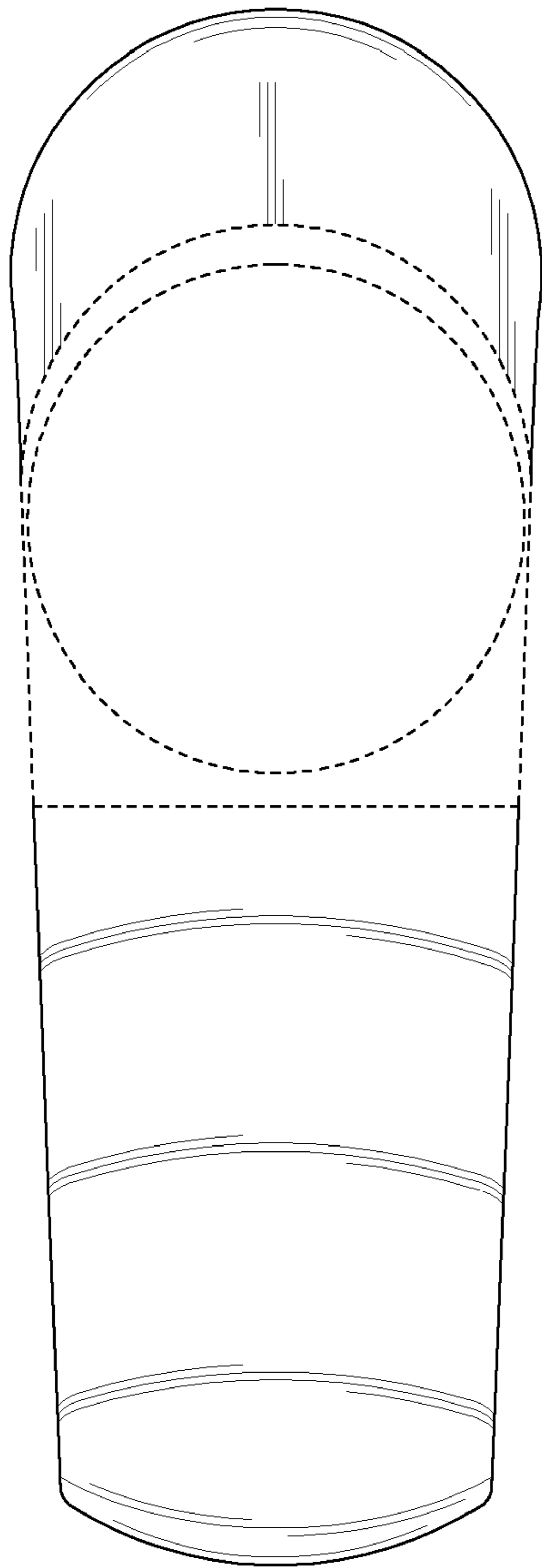

FIG. 5

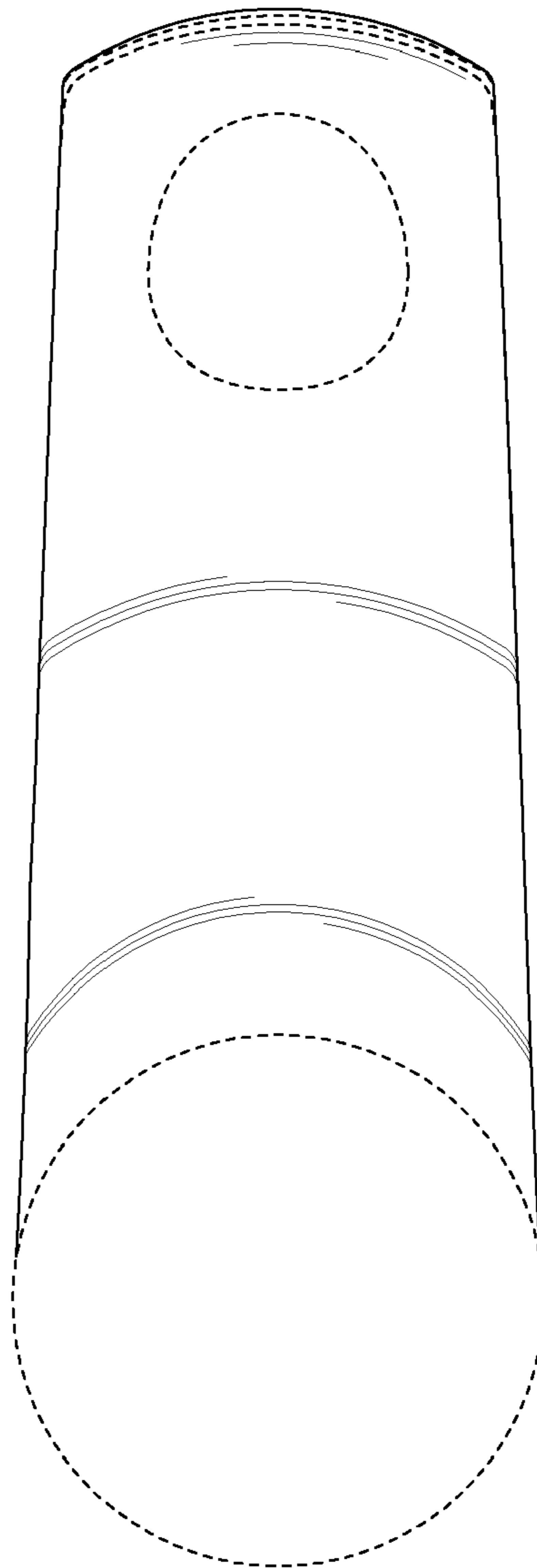

FIG. 6