



US00D635624S

(12) **United States Design Patent**
Brown et al.

(10) **Patent No.:** **US D635,624 S**

(45) **Date of Patent:** **** Apr. 5, 2011**

(54) **POSTURE DEVICE**

(76) Inventors: **Collon Brown**, Toronto (CA); **Marina Elena Prospero**, Toronto (CA)

(**) Term: **14 Years**

(21) Appl. No.: **29/363,993**

(22) Filed: **Jun. 17, 2010**

(51) **LOC (9) Cl.** **21-02**

(52) **U.S. Cl.** **D21/692; D24/190**

(58) **Field of Classification Search** D21/662,
D21/679, 692, 693, 694; 482/91, 111-112,
482/121-122, 128-129, 124-126; D24/190;
602/4, 19

See application file for complete search history.

(56) **References Cited**

U.S. PATENT DOCUMENTS

| | | | | | | |
|-----------|---|---|--------|--------------|-------|---------|
| D45,984 | S | * | 6/1914 | Bowers | | D24/190 |
| 3,718,137 | A | * | 2/1973 | Gaylord, Jr. | | 602/19 |
| 3,897,776 | A | * | 8/1975 | Gaylord, Jr. | | 602/19 |
| 4,023,808 | A | * | 5/1977 | Hebert | | 482/126 |
| D245,537 | S | * | 8/1977 | Gurgiolo | | D24/190 |

| | | | | | | |
|--------------|----|---|---------|------------------|-------|---------|
| D301,271 | S | * | 5/1989 | Greenfeld et al. | | D21/692 |
| D370,951 | S | * | 6/1996 | Lazar | | D21/692 |
| 5,857,945 | A | * | 1/1999 | Papp et al. | | 482/124 |
| D431,618 | S | * | 10/2000 | Royce | | D21/692 |
| 6,315,747 | B1 | * | 11/2001 | Toole | | 602/19 |
| 2004/0143204 | A1 | * | 7/2004 | Salmon et al. | | 602/19 |
| 2006/0161082 | A1 | * | 7/2006 | Rhee | | 602/4 |
| 2008/0319364 | A1 | * | 12/2008 | Josey | | 602/19 |

* cited by examiner

Primary Examiner — Susan E Krakower

(74) *Attorney, Agent, or Firm* — Sinorica, LLC

(57) **CLAIM**

The ornamental design for a posture device, as shown and described.

DESCRIPTION

FIG. 1 is a perspective view of a posture device;

FIG. 2 is a front elevational view thereof;

FIG. 3 is a rear elevational view thereof;

FIG. 4 is a top plan view thereof;

FIG. 5 is a bottom plan view thereof;

FIG. 6 is a left-side elevational view thereof; and,

FIG. 7 is a right-side elevational view thereof.

1 Claim, 5 Drawing Sheets

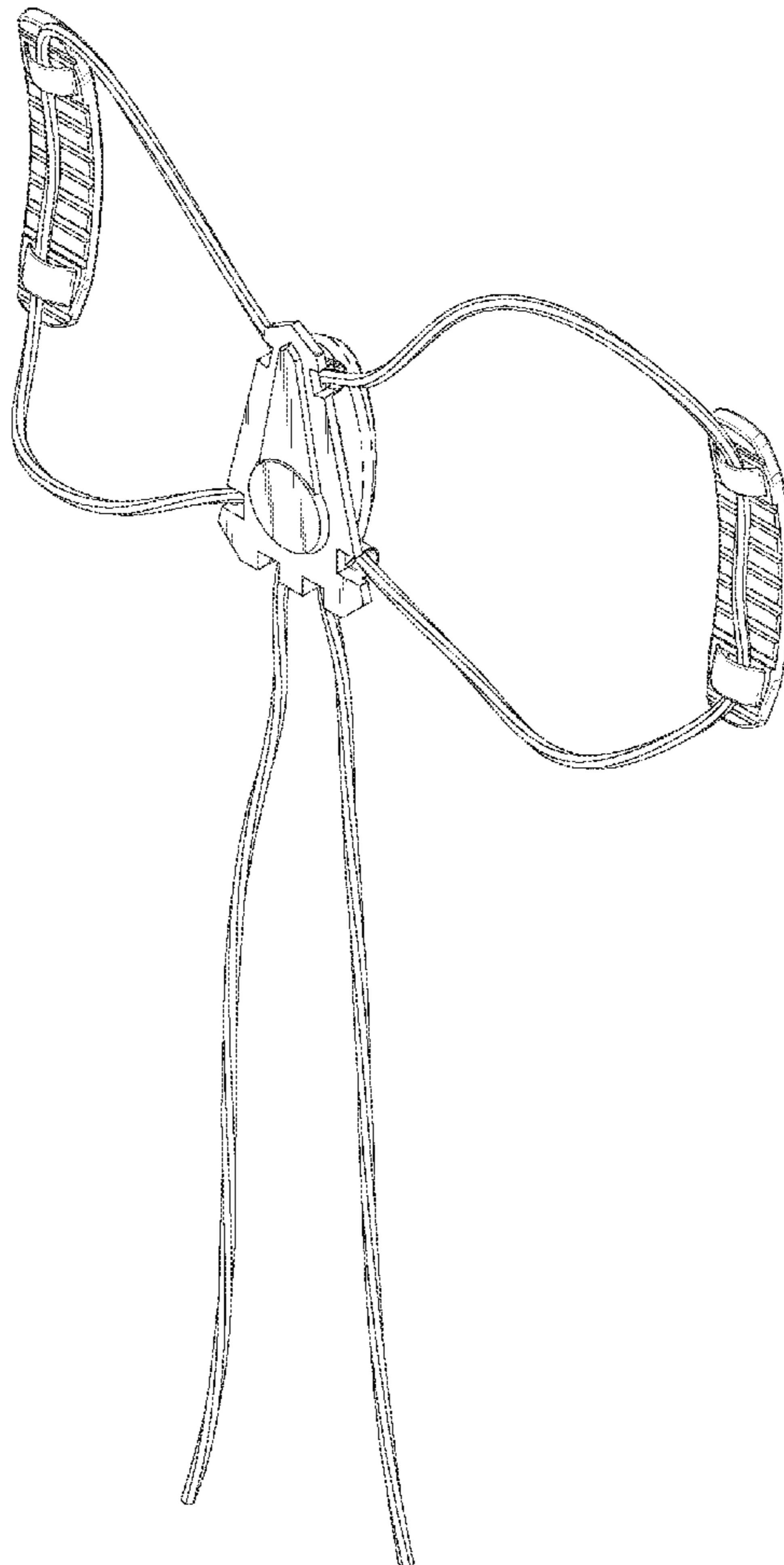

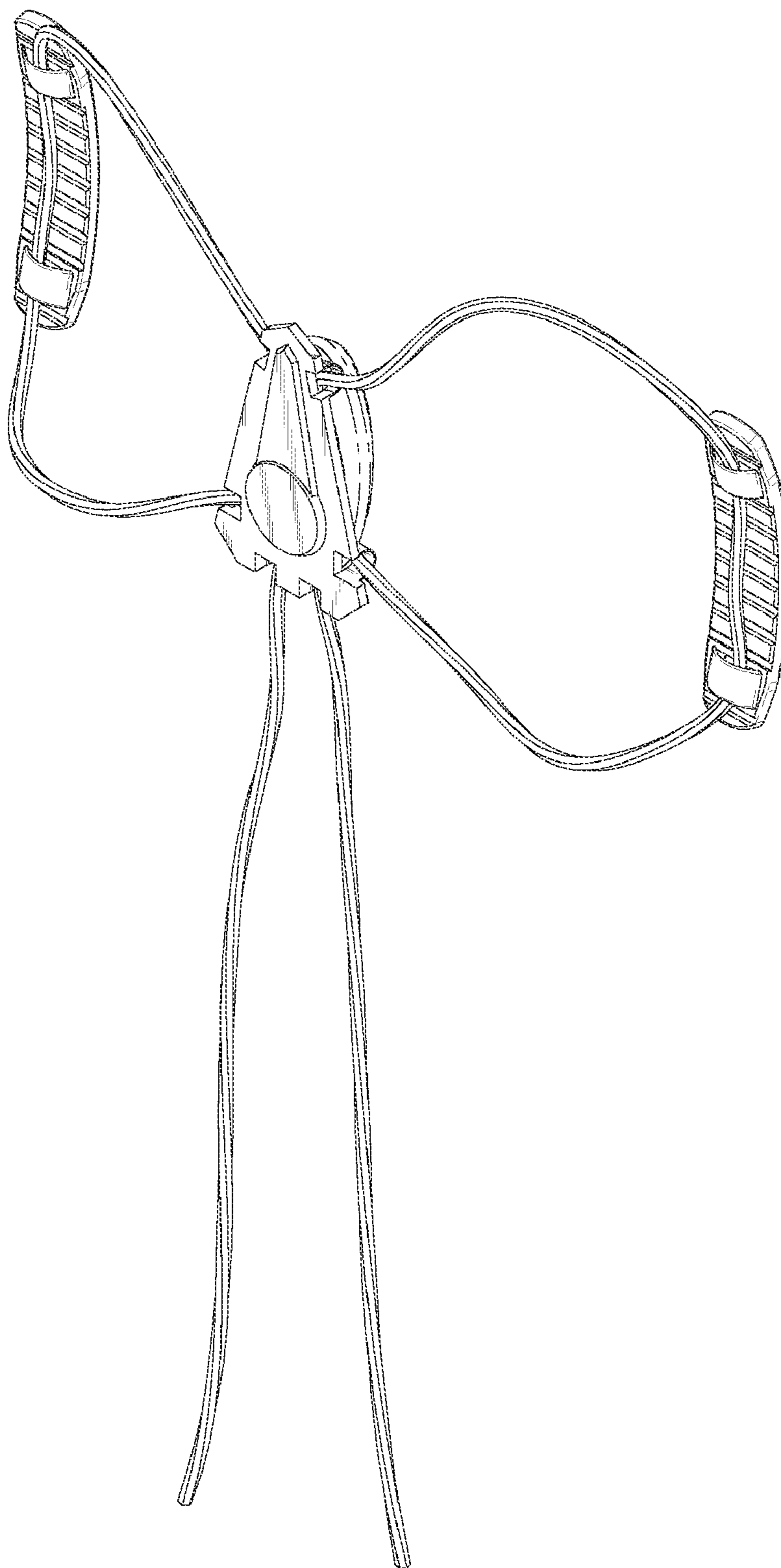

FIG. 1

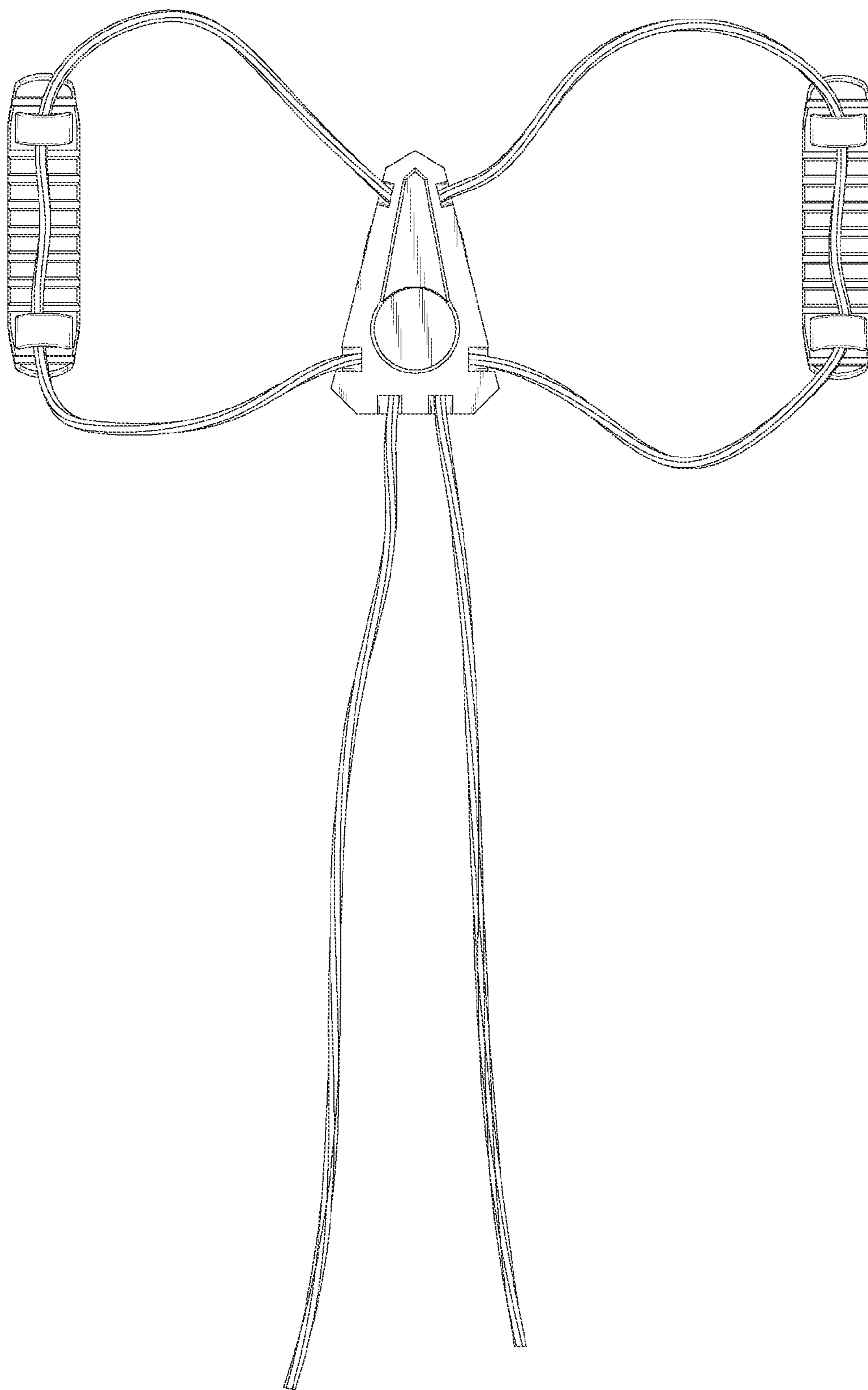

FIG. 2

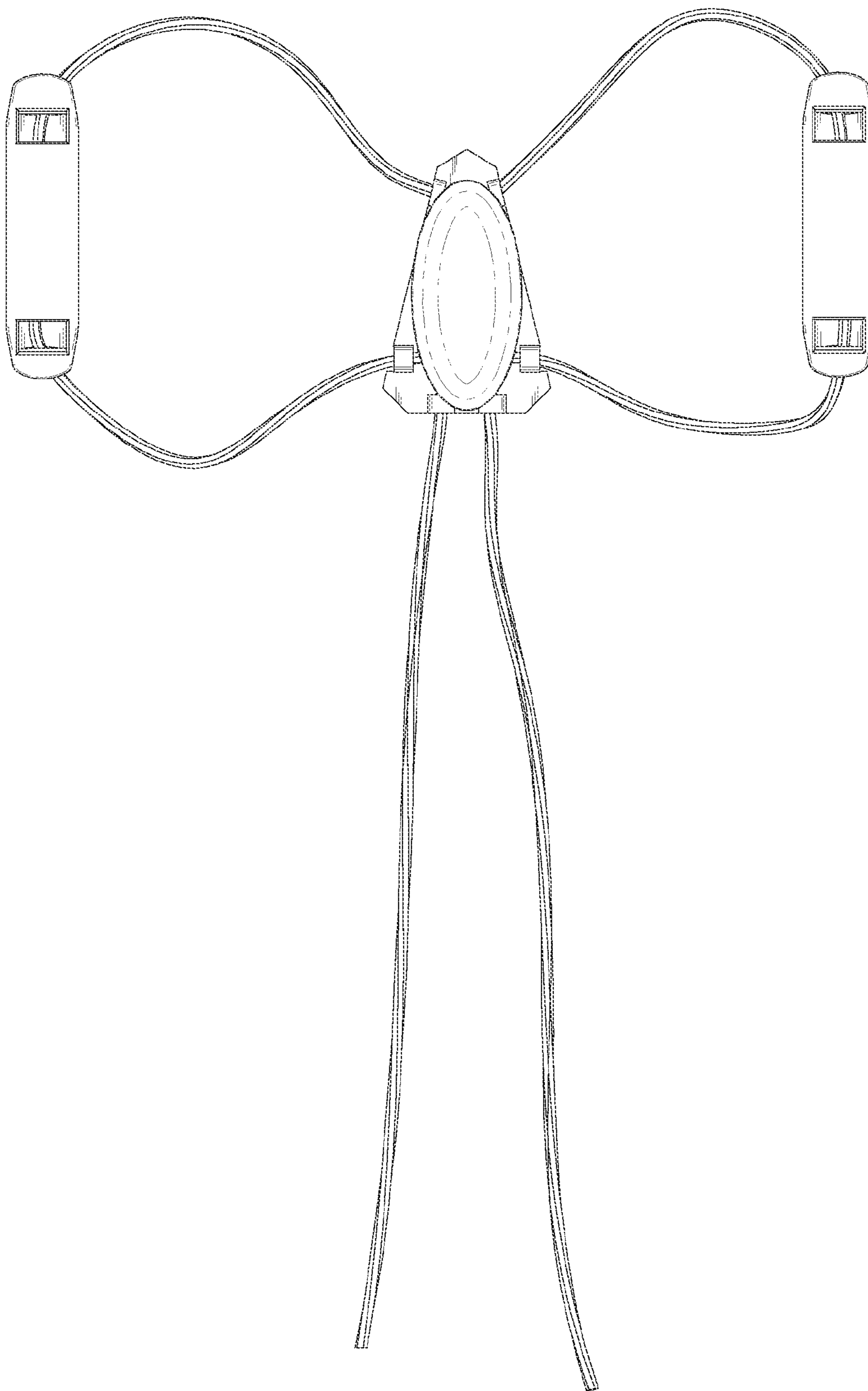

FIG. 3

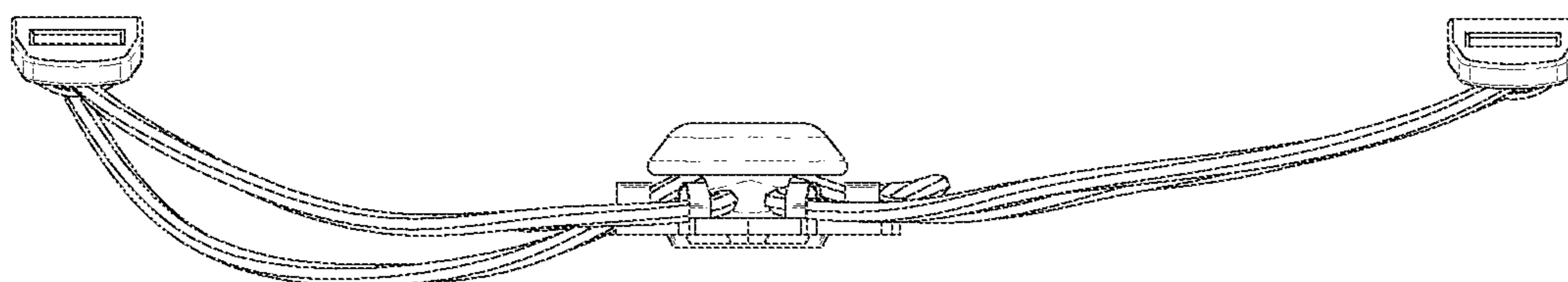

FIG. 4

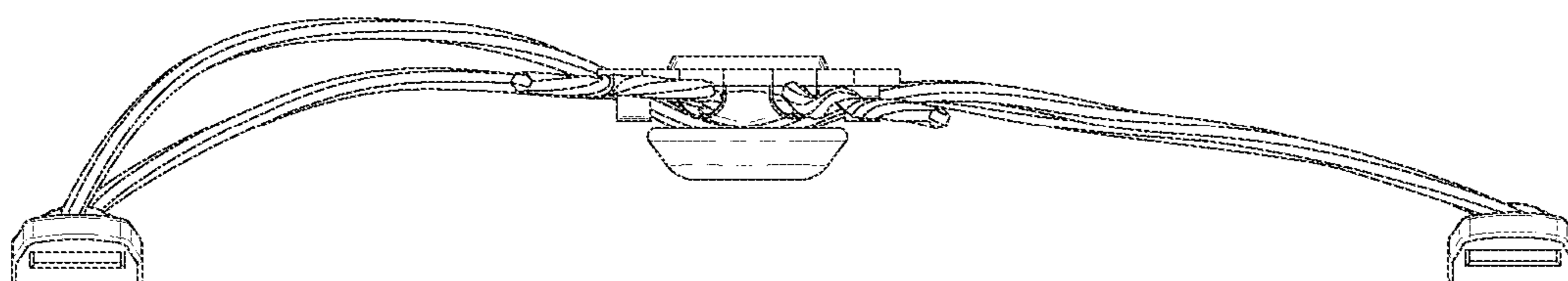

FIG. 5

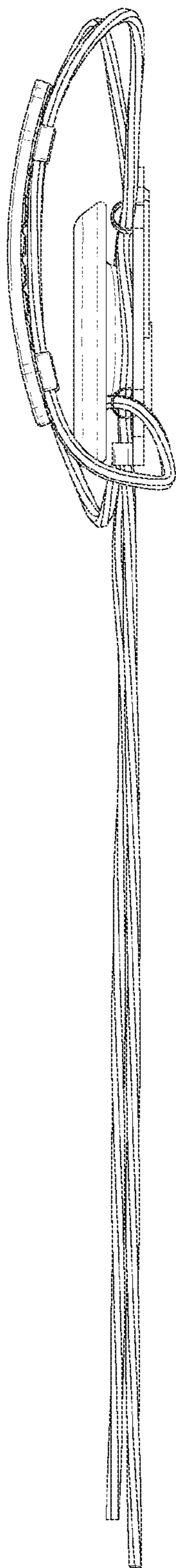

FIG. 6

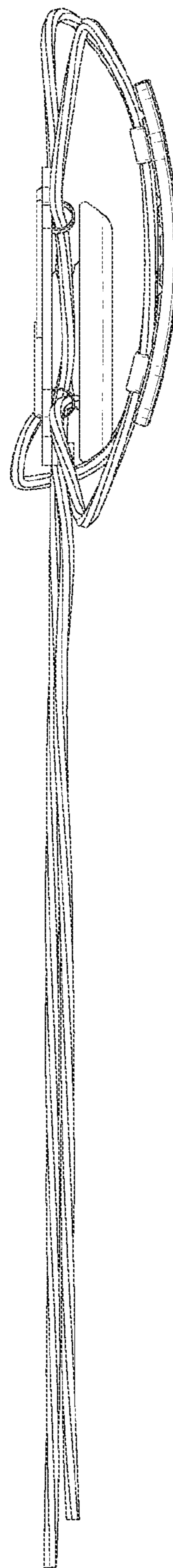

FIG. 7