



US00D635543S

(12) **United States Design Patent**
Li

(10) **Patent No.:** **US D635,543 S**

(45) **Date of Patent:** **** Apr. 5, 2011**

(54) **MOBILE PHONE**

- (75) Inventor: **Jian-Hui Li**, Shenzhen (CN)
- (73) Assignee: **FIH (Hong Kong) Limited**, Kowloon (HK)
- (**) Term: **14 Years**
- (21) Appl. No.: **29/367,351**

(22) Filed: **Aug. 6, 2010**

- (51) **LOC (9) Cl.** **14-03**
- (52) **U.S. Cl.** **D14/138 AB; D14/138 R; D14/138 AC**
- (58) **Field of Classification Search** D14/138 AB, D14/496, 341, 345, 346, 203.3, 203.4, 203.7, D14/138 R, 138 AD, 138 G, 138 AC, 240, D14/140.8, 140.11, 356; 455/575.3, 556.2; D21/517; 379/433.13

See application file for complete search history.

(56) **References Cited**

U.S. PATENT DOCUMENTS

D415,164 S *	10/1999	Hadar	D14/240
D463,424 S *	9/2002	Ausems	D14/343
D494,585 S *	8/2004	Aupperle	D14/346
D494,950 S *	8/2004	Keunecke	D14/138 AA
D499,710 S *	12/2004	Chauhan	D14/138 R
D502,466 S *	3/2005	Aupperle	D14/390
6,989,984 B2 *	1/2006	Sutton et al.	361/679.16
D539,812 S *	4/2007	Chuang	D14/203.7
D559,813 S *	1/2008	Cho et al.	D14/138 AB
D567,808 S *	4/2008	Kanne et al.	D14/240
D568,862 S *	5/2008	Kim et al.	D14/138 AB
D573,565 S *	7/2008	Edwards	D14/138 AA
7,433,721 B2 *	10/2008	Kuroda	455/575.3
D583,353 S *	12/2008	Brown et al.	D14/140.8
D595,253 S *	6/2009	Kim	D14/138 R
D613,716 S *	4/2010	Liu	D14/138 G
D620,471 S *	7/2010	Huang	D14/138 AC
7,756,554 B2 *	7/2010	Jung	455/575.3
D620,909 S *	8/2010	Lee et al.	D14/138 AD

(Continued)

OTHER PUBLICATIONS

Sagem MC 939 WAP telephone, announced 2000, [online], [site visited Dec. 1, 2010]. Available from Internet, <URL: <http://www.gsmarena.com>>.*

(Continued)

Primary Examiner — Jeffrey D Asch

(74) *Attorney, Agent, or Firm* — Steven M. Reiss

(57) **CLAIM**

The ornamental design for a mobile phone, as shown and described.

DESCRIPTION

FIG. 1 is a perspective view of the mobile phone in a first configuration;
 FIG. 2 is a front elevational view of the mobile phone in the first configuration;
 FIG. 3 is a rear elevational view of the mobile phone in the first configuration;
 FIG. 4 is a left side elevational view of the mobile phone in the first configuration;
 FIG. 5 is a right side elevational view of the mobile phone in the first configuration;
 FIG. 6 is a top plan view of the mobile phone in the first configuration;
 FIG. 7 is a bottom plan view of the mobile phone in the first configuration;
 FIG. 8 is a perspective view of the mobile phone of FIG. 1 in a second configuration;
 FIG. 9 is a front elevational view of the mobile phone in the second configuration;
 FIG. 10 is a rear elevational view of the mobile phone in the second configuration;
 FIG. 11 is a left side elevational view of the mobile phone in the second configuration;
 FIG. 12 is a right side elevational view of the mobile phone in the second configuration;
 FIG. 13 is a top plan view of the mobile phone in the second configuration; and,
 FIG. 14 is a bottom plan view of the mobile phone in the second configuration.

The broken lines immediately adjacent the claimed areas represent the bounds of the claimed design while all other broken lines are directed to environment and are for illustrative purposes only; the broken lines form no part of the claimed design.

1 Claim, 14 Drawing Sheets

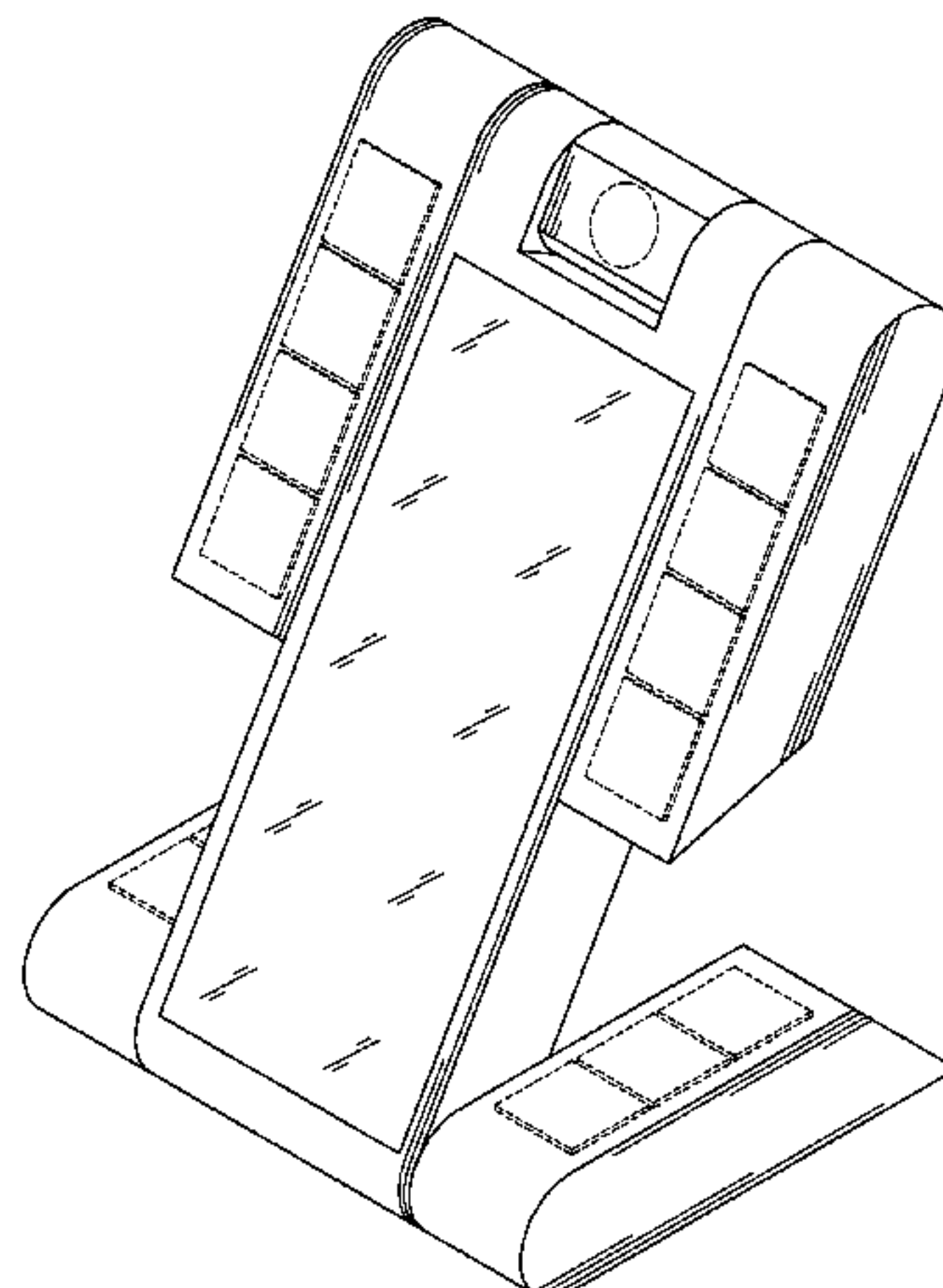
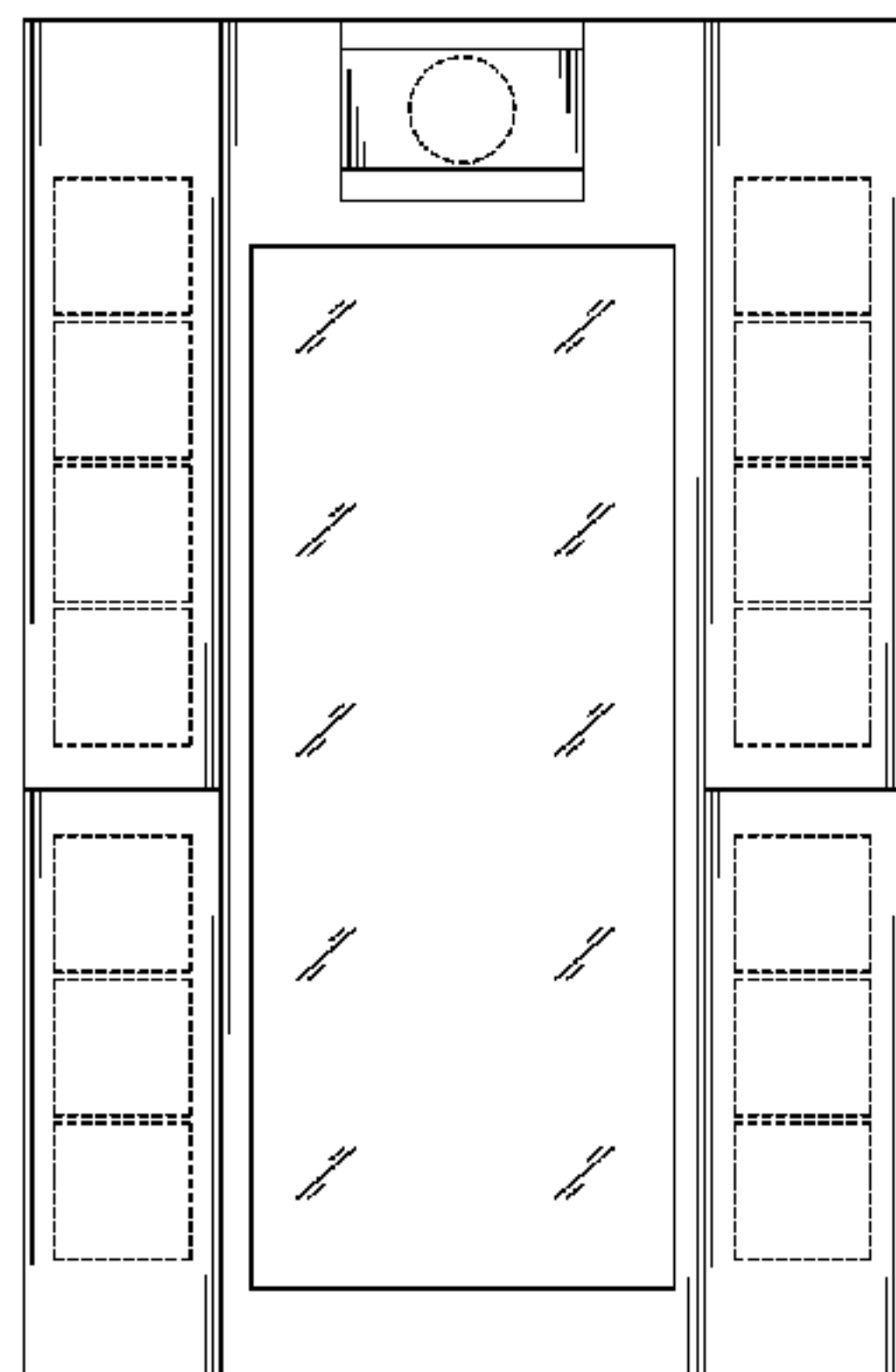

US D635,543 S

Page 2

U.S. PATENT DOCUMENTS

D625,284 S * 10/2010 Cha D14/138 AB
2003/0073414 A1 * 4/2003 Capps 455/90
2005/0070328 A1 * 3/2005 Wang et al. 455/556.1
2006/0035678 A1 * 2/2006 Jaakkola 455/566
2006/0142074 A1 * 6/2006 Impio et al. 455/575.4
2007/0198954 A1 * 8/2007 Dinn 715/864
2007/0259702 A1 * 11/2007 Kempainen 455/575.4
2009/0186663 A1 * 7/2009 Griffin et al. 455/566
2010/0004036 A1 * 1/2010 Liu 455/575.1
2010/0085697 A1 * 4/2010 Park et al. 361/679.27

OTHER PUBLICATIONS

Samsung B3310 telephone, announced Aug. 2009, [online], [site visited Dec. 1, 2010]. Available from Internet ,<URL: <http://www.gsmarena.com>>.*

NEC N200 telephone, announced 1st quarter 2005, [online], [site visited Dec. 1, 2010]. Available from Internet ,<URL: <http://www.gsmarena.com>>.*

* cited by examiner

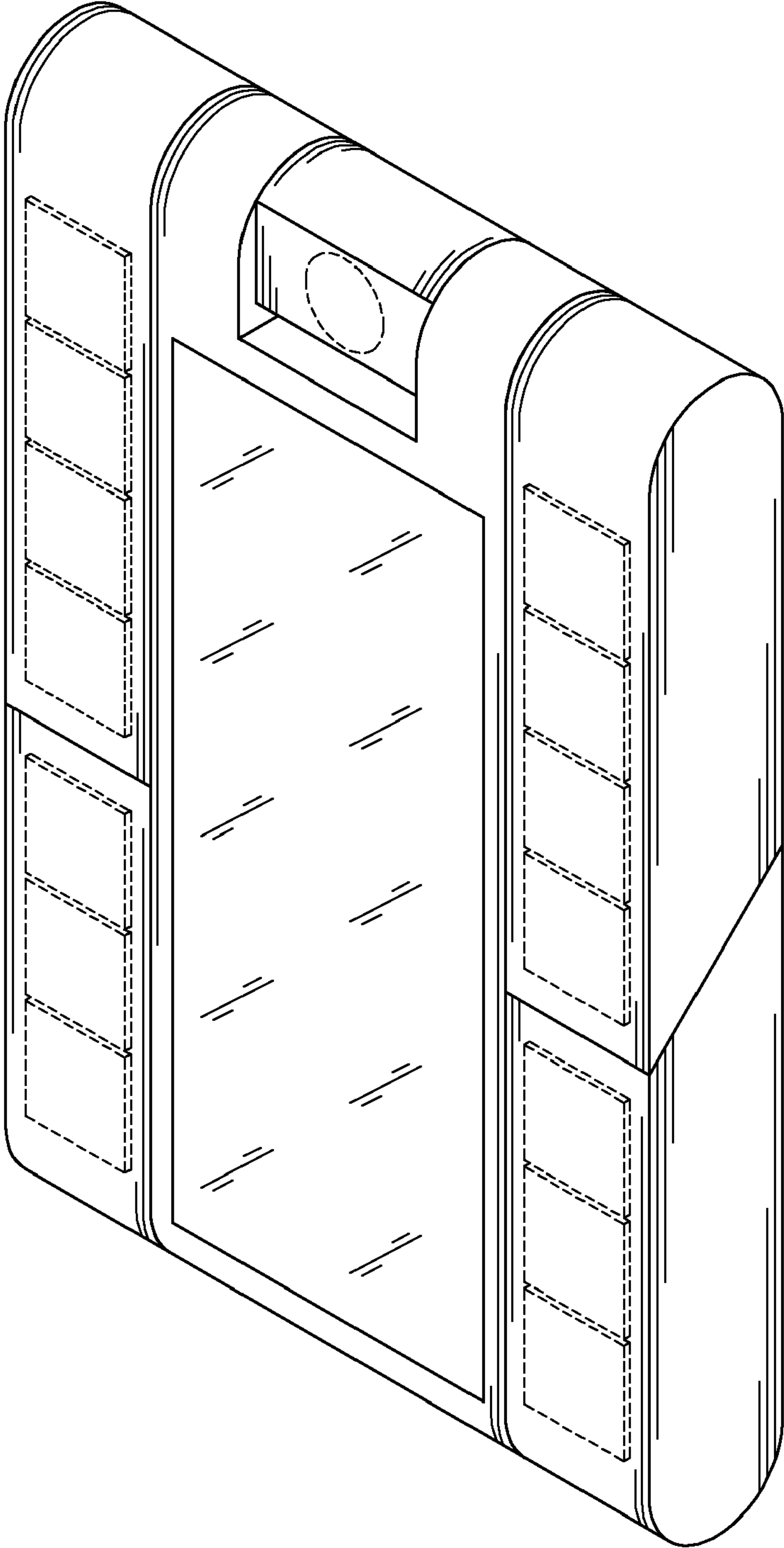

FIG. 1

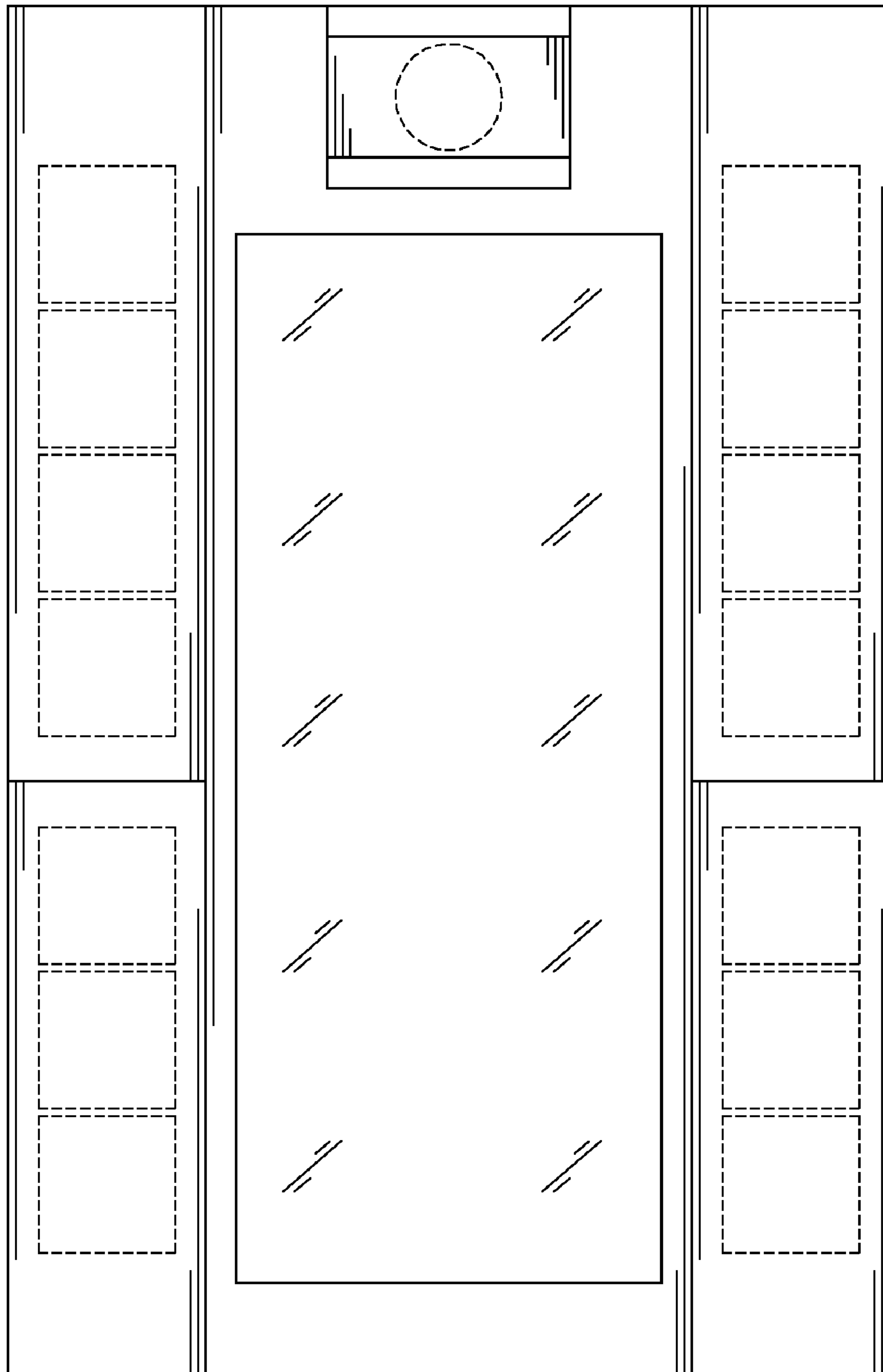

FIG. 2

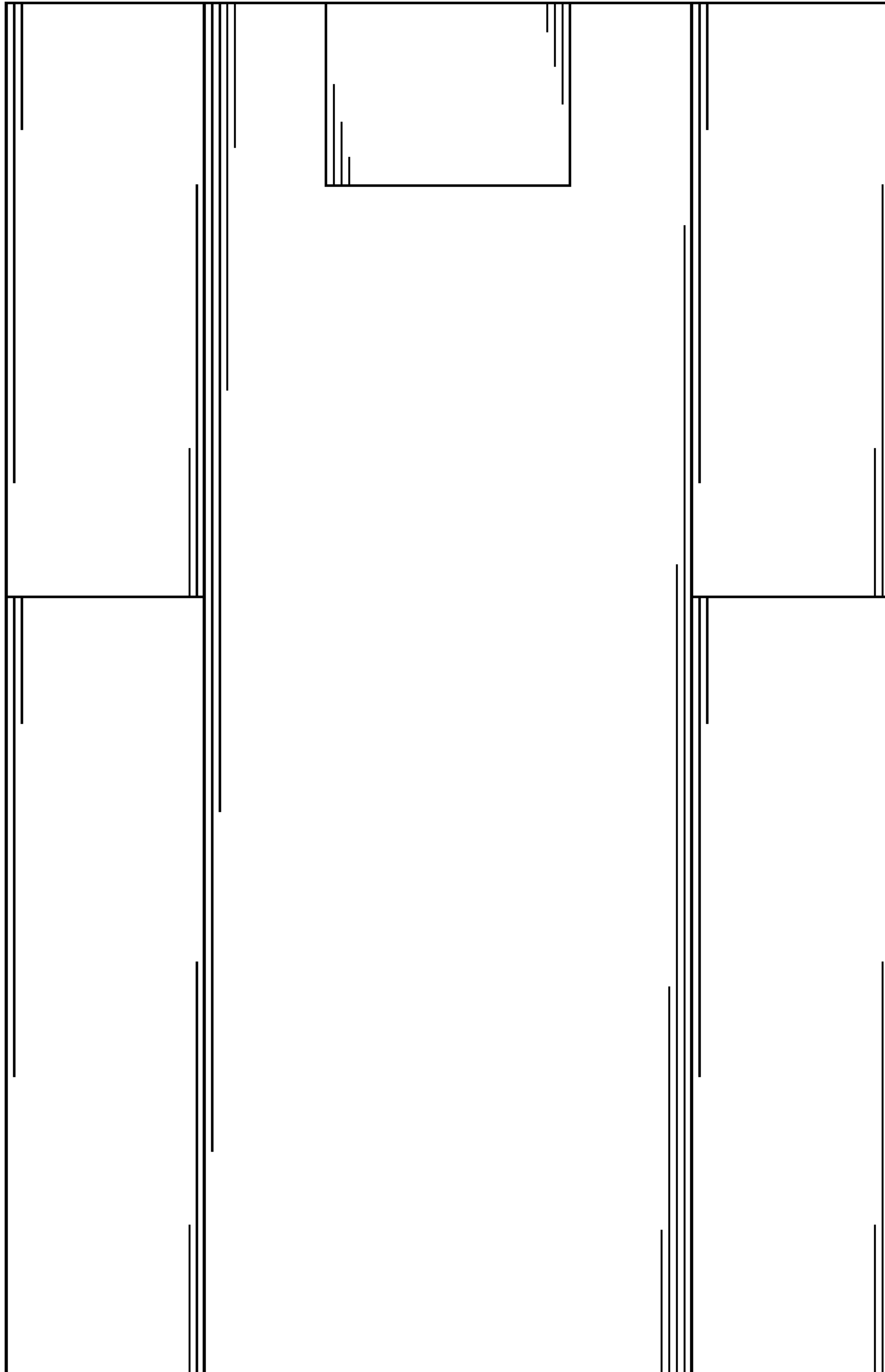

FIG. 3

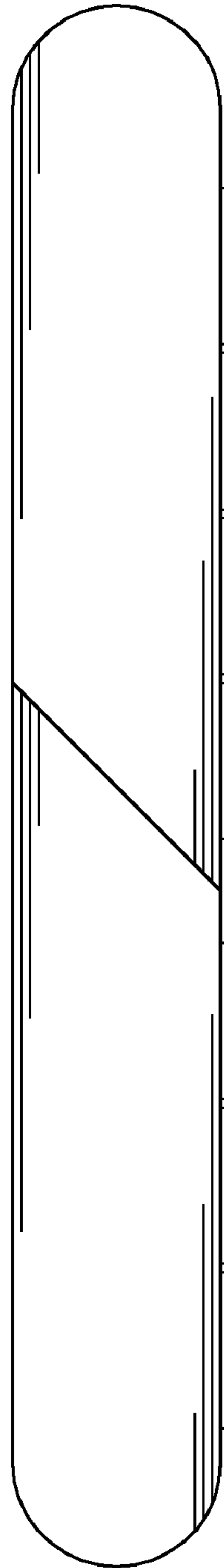

FIG. 4

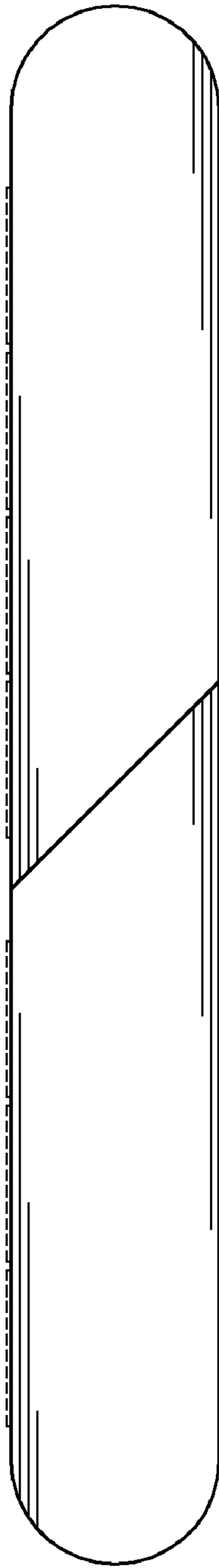

FIG. 5

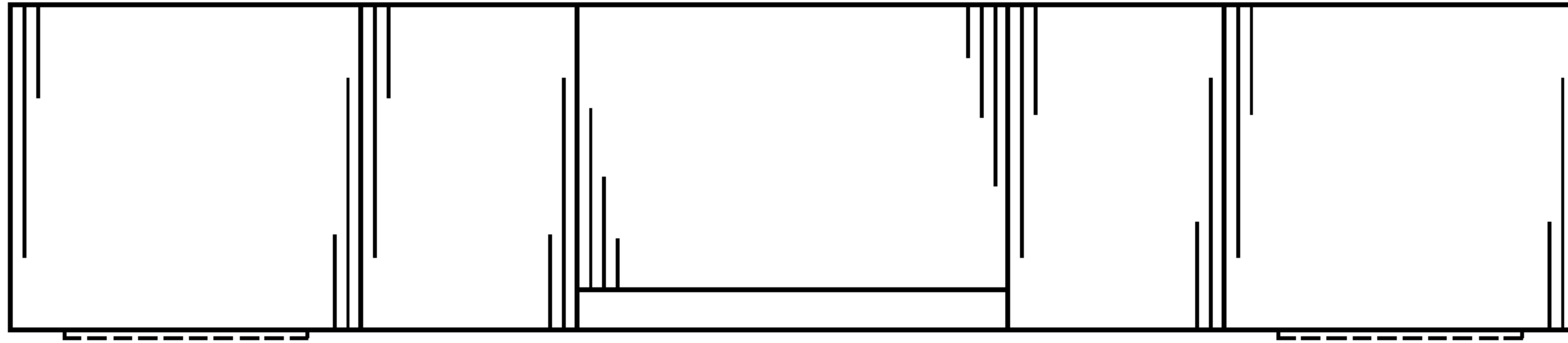

FIG. 6



FIG. 7

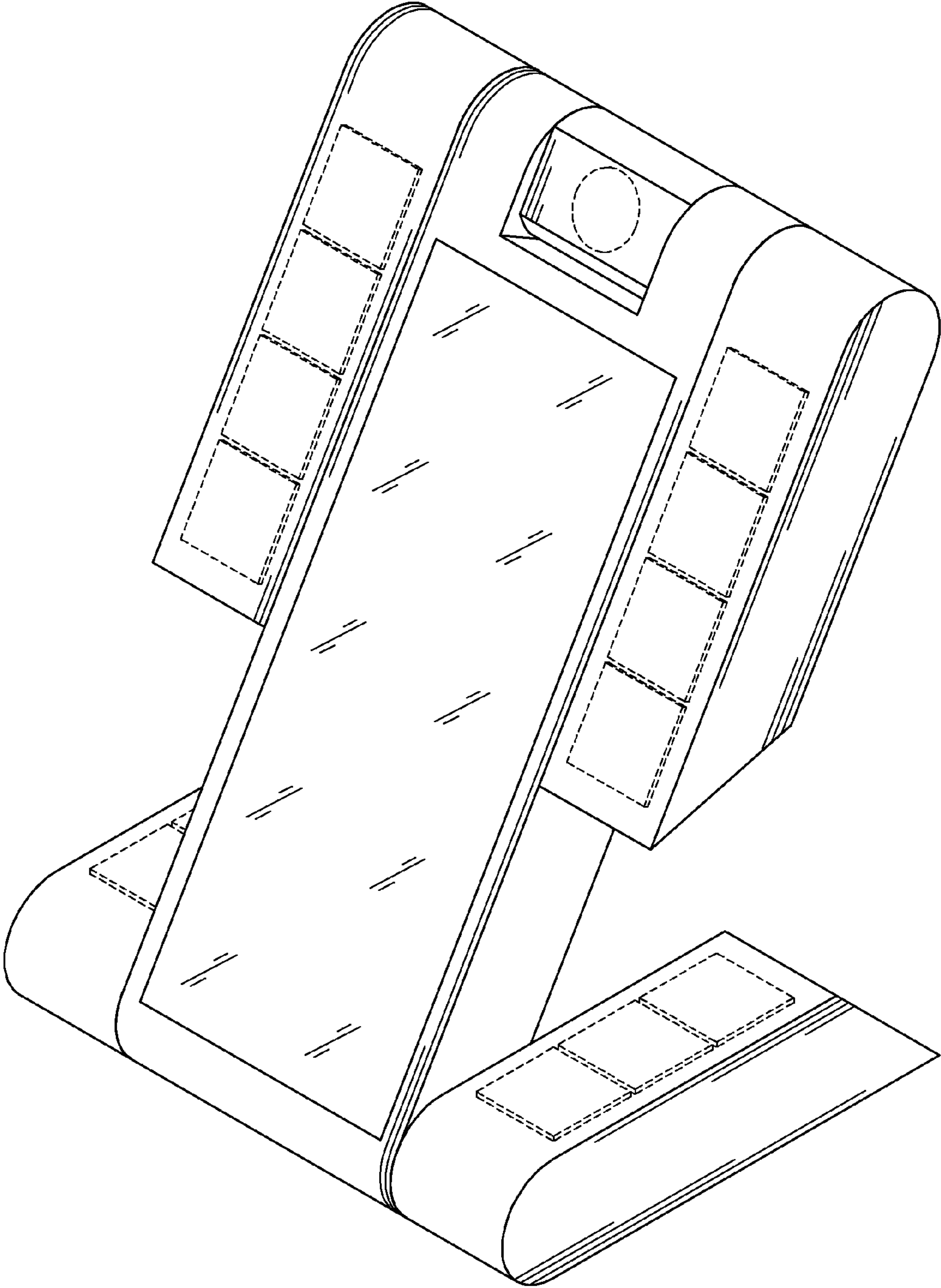

FIG. 8

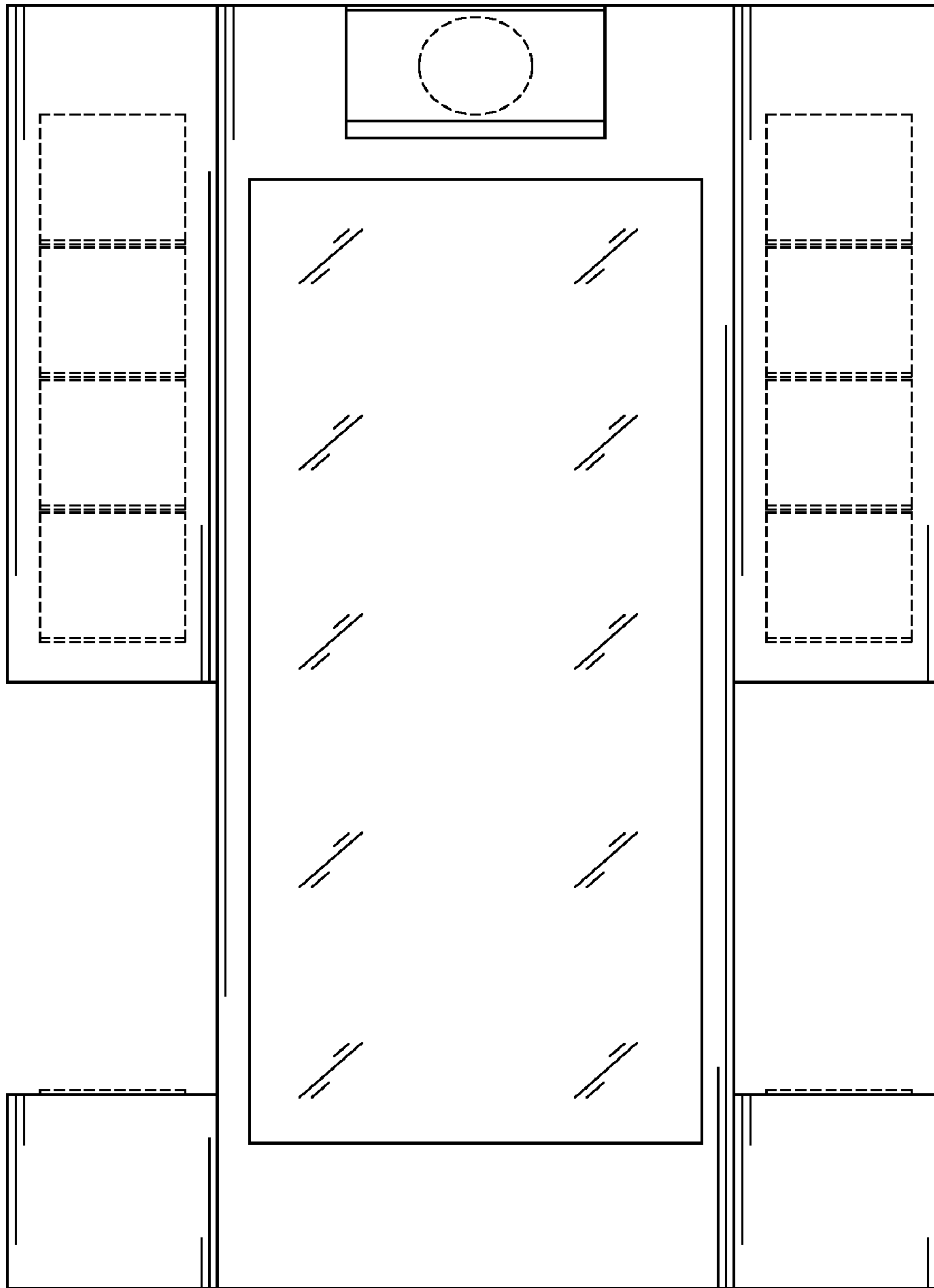

FIG. 9

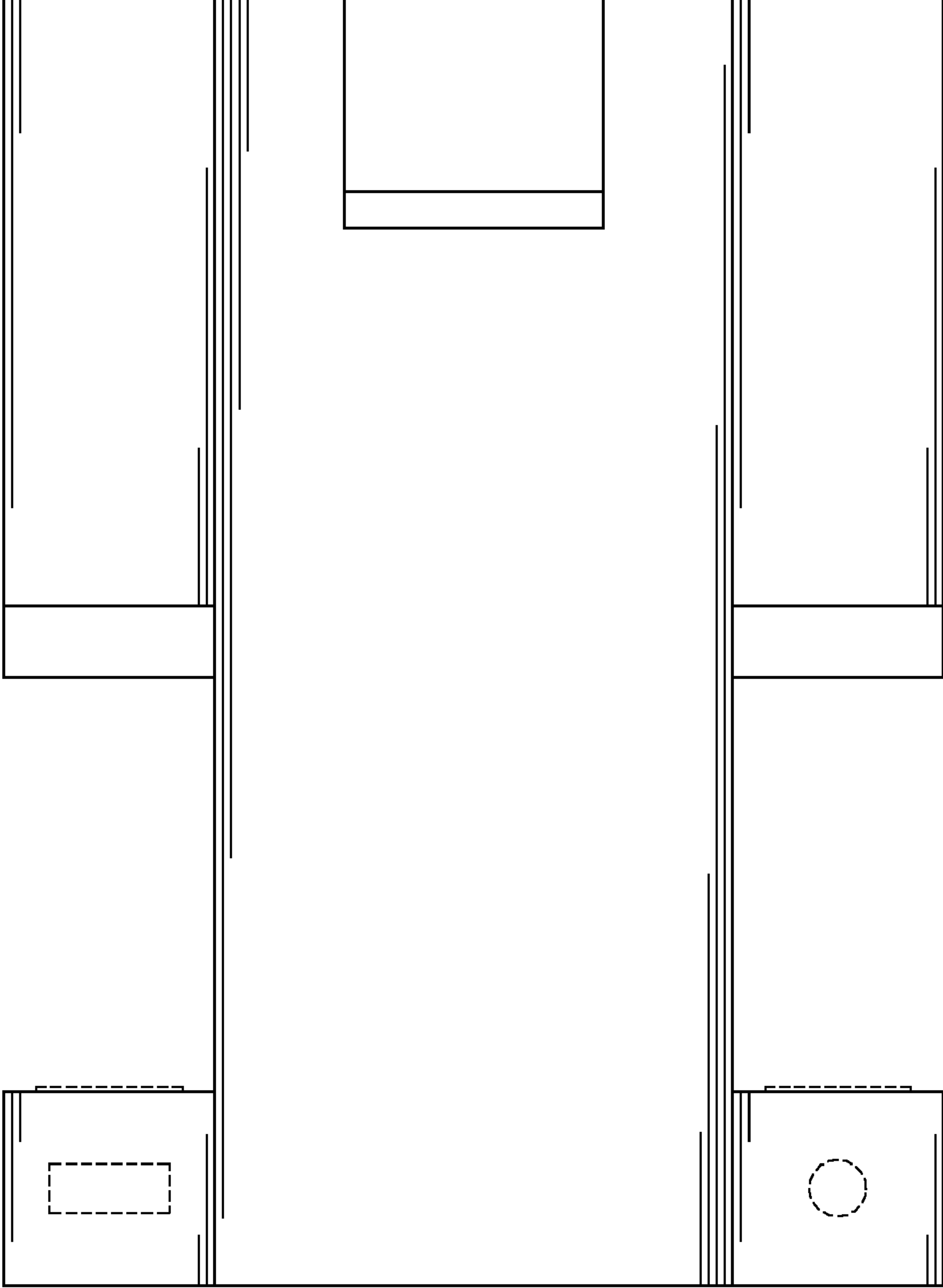

FIG. 10

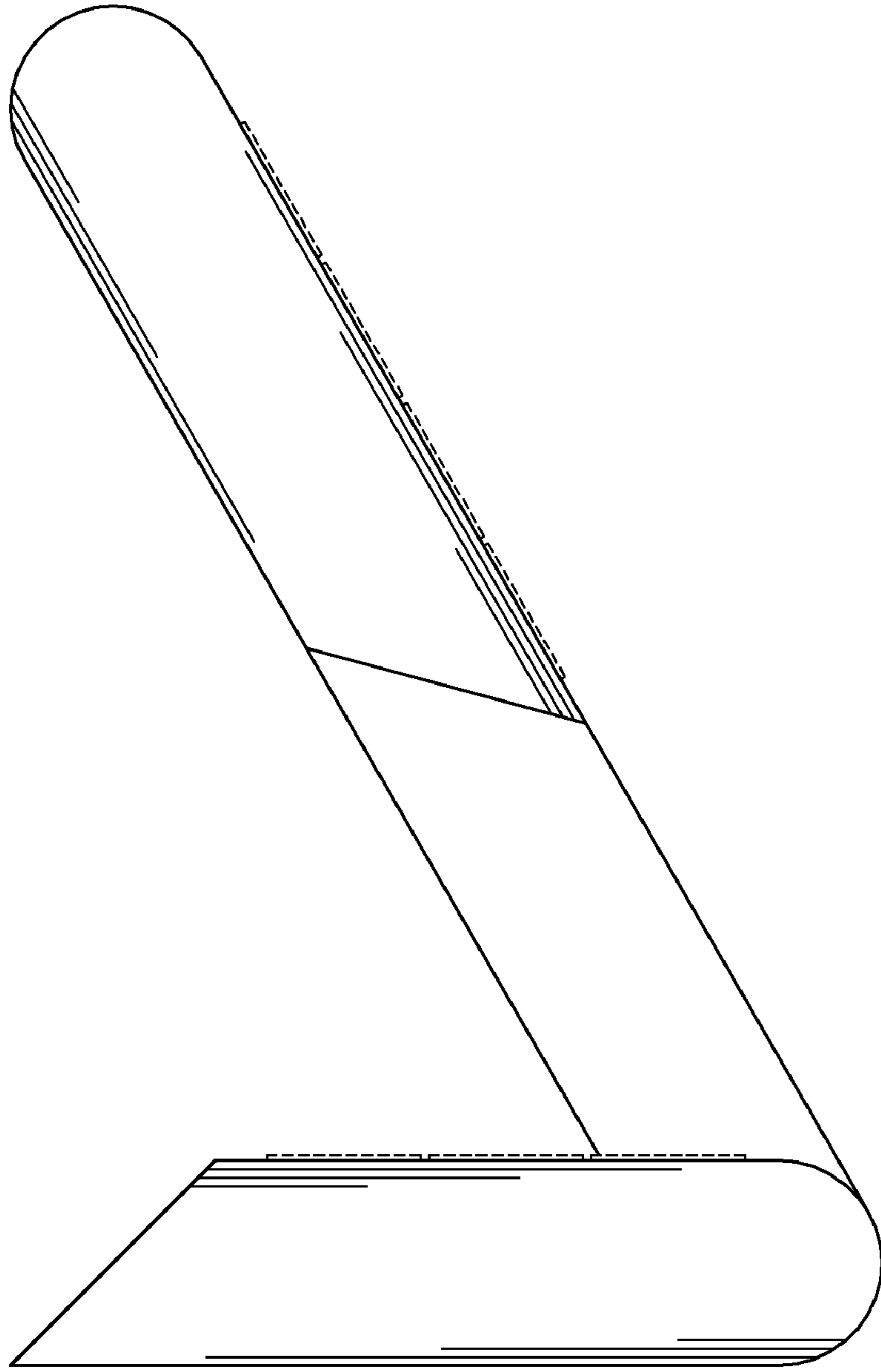

FIG. 11

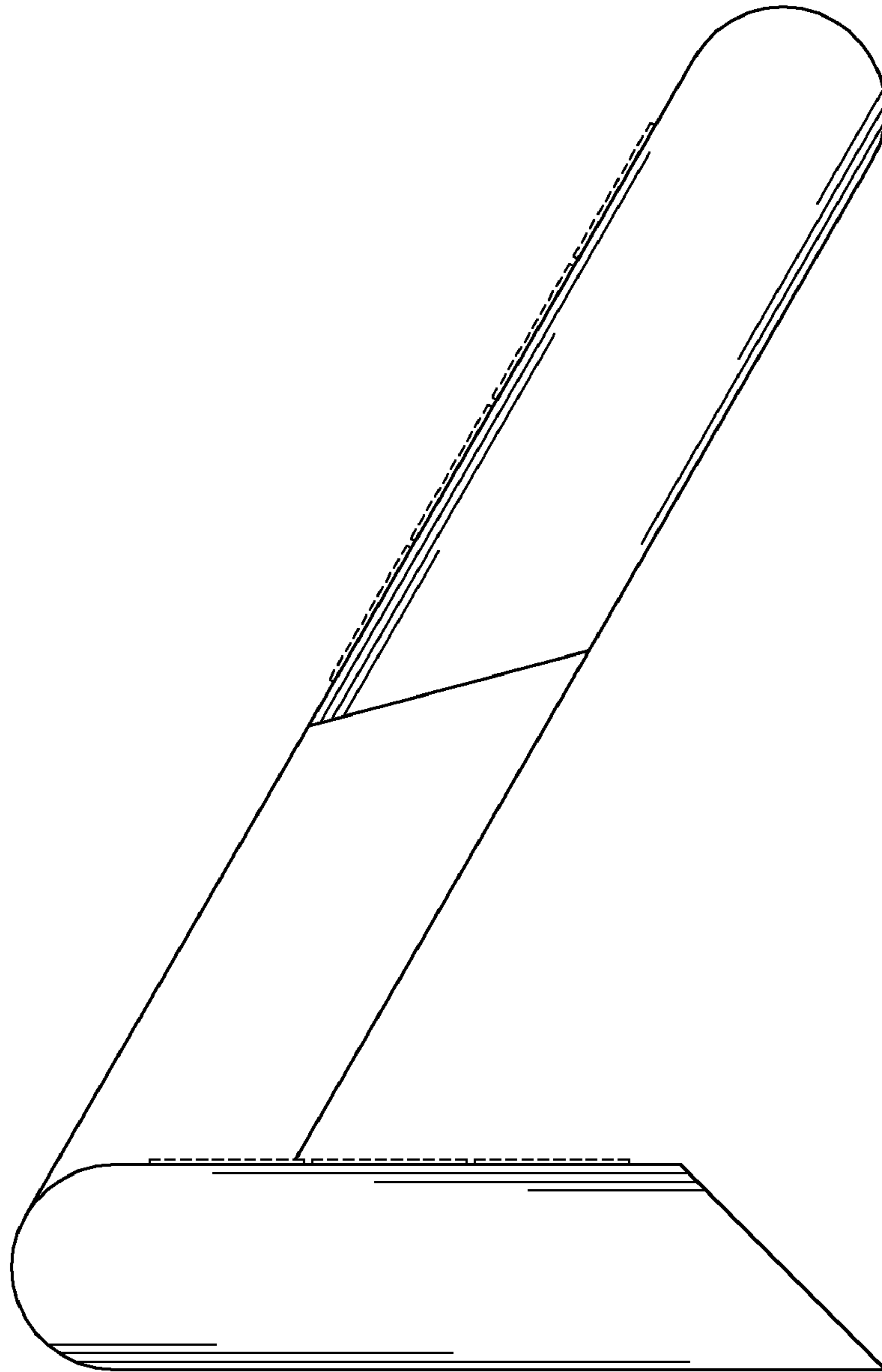

FIG. 12

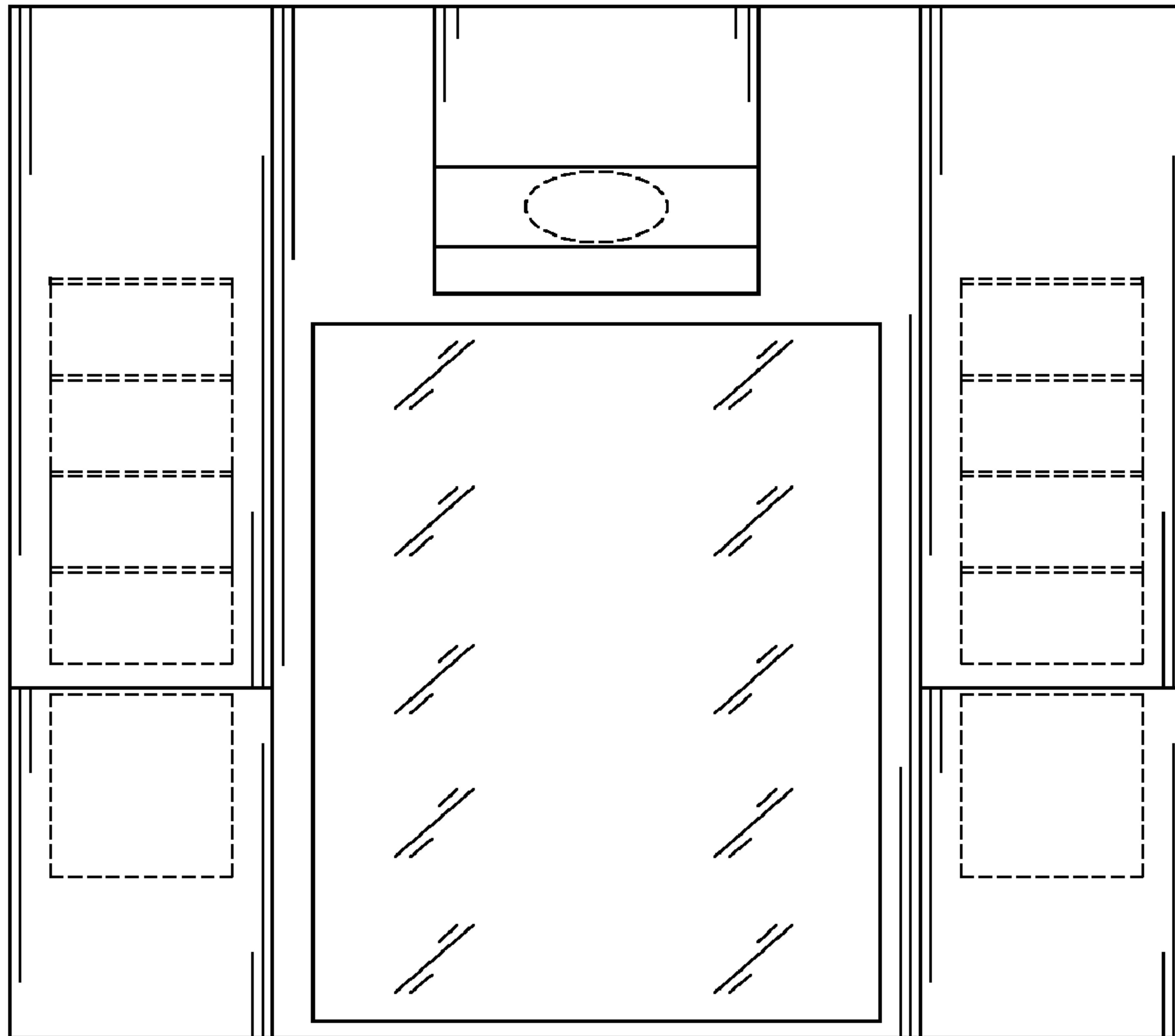

FIG. 13

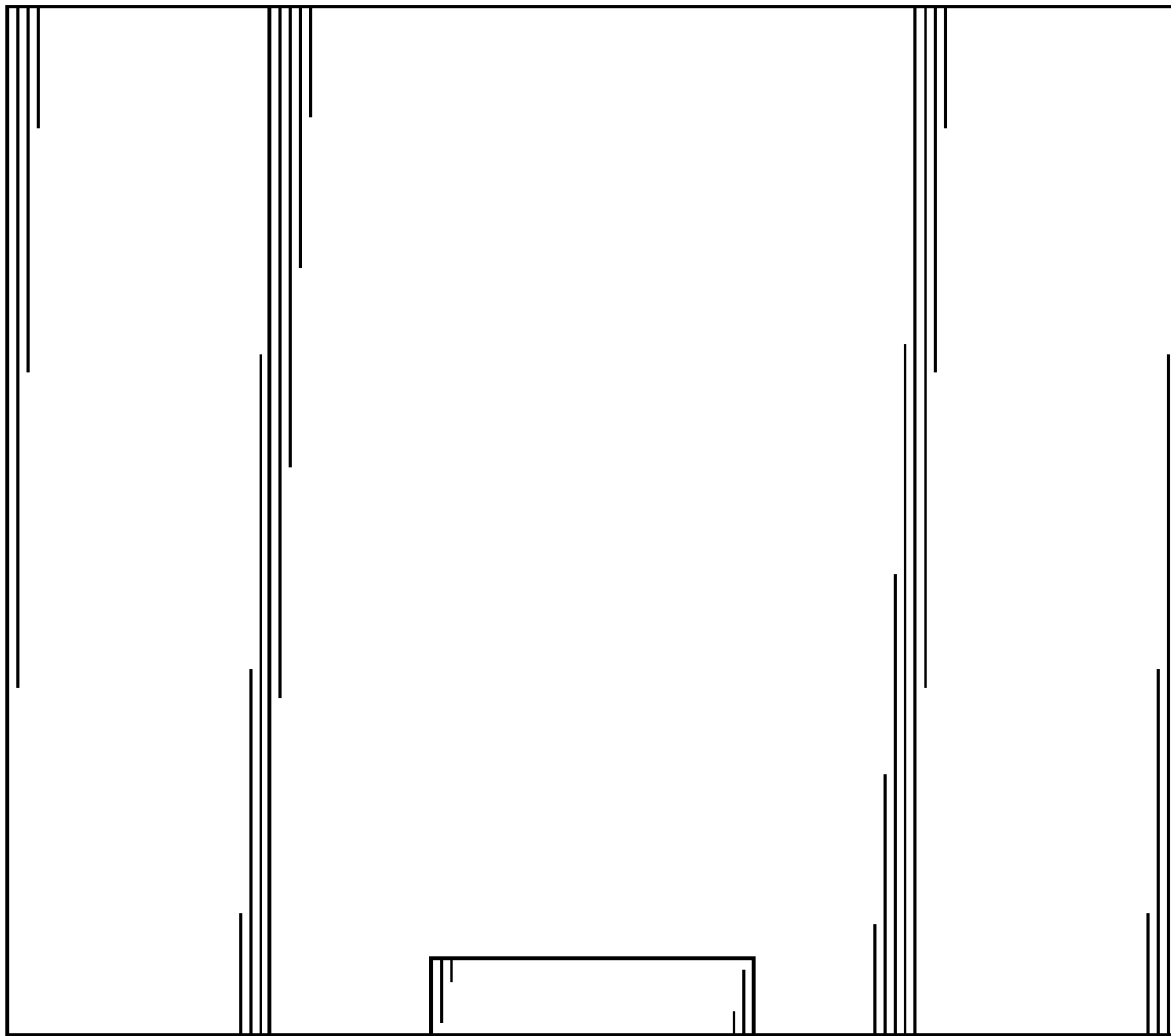

FIG. 14