



US00D635452S

(12) **United States Design Patent**
Jones

(10) **Patent No.:** **US D635,452 S**

(45) **Date of Patent:** **** Apr. 5, 2011**

(54) **BUNGEE CORD KEEPER**

(76) Inventor: **Mack E Jones**, Palm Springs, CA (US)

(**) Term: **14 Years**

(21) Appl. No.: **29/349,069**

(22) Filed: **Mar. 5, 2010**

(51) **LOC (9) Cl.** **08-08**

(52) **U.S. Cl.** **D8/383**

(58) **Field of Classification Search** D8/383,
D8/356; D11/216, 215, 212; 24/170, 191,
24/22, 16 R, 33 A, 33 F, 68 E, 115 G, 115 M,
24/115 R

See application file for complete search history.

(56) **References Cited**

U.S. PATENT DOCUMENTS

D312,207 S *	11/1990	Bateman	D8/383
D556,033 S *	11/2007	Ennest et al.	D8/383
D567,641 S *	4/2008	Clarke	D8/383
D568,730 S *	5/2008	Clarke	D8/383
D572,099 S *	7/2008	Fontaine et al.	D8/44
D574,701 S *	8/2008	Clarke	D8/383
D610,036 S *	2/2010	Balensiefer, II	D11/201

* cited by examiner

Primary Examiner — Holly H Baynham

Assistant Examiner — Sheryl Lane

(74) *Attorney, Agent, or Firm* — Loyal McKinley Hanson

(57) **CLAIM**

I claim the ornamental design for a bungee cord keeper, as shown and described.

DESCRIPTION

FIG. 1 of the drawings is a perspective view showing the front, left side, and top of a bungee cord keeper embodying the design of my invention;

FIG. 2 is a front elevation view of the bungee cord keeper;

FIG. 3 is a left side elevation view;

FIG. 4 is a top plan view;

FIG. 5 is a right side elevation view;

FIG. 6 is a back elevation view;

FIG. 7 is a bottom view; and,

FIG. 8 is another perspective view of the bungee cord keeper shown reduced in size and in its usual bungee cord environment. The broken lines depict a typical bungee cord and they form no part of the claimed design.

1 Claim, 3 Drawing Sheets

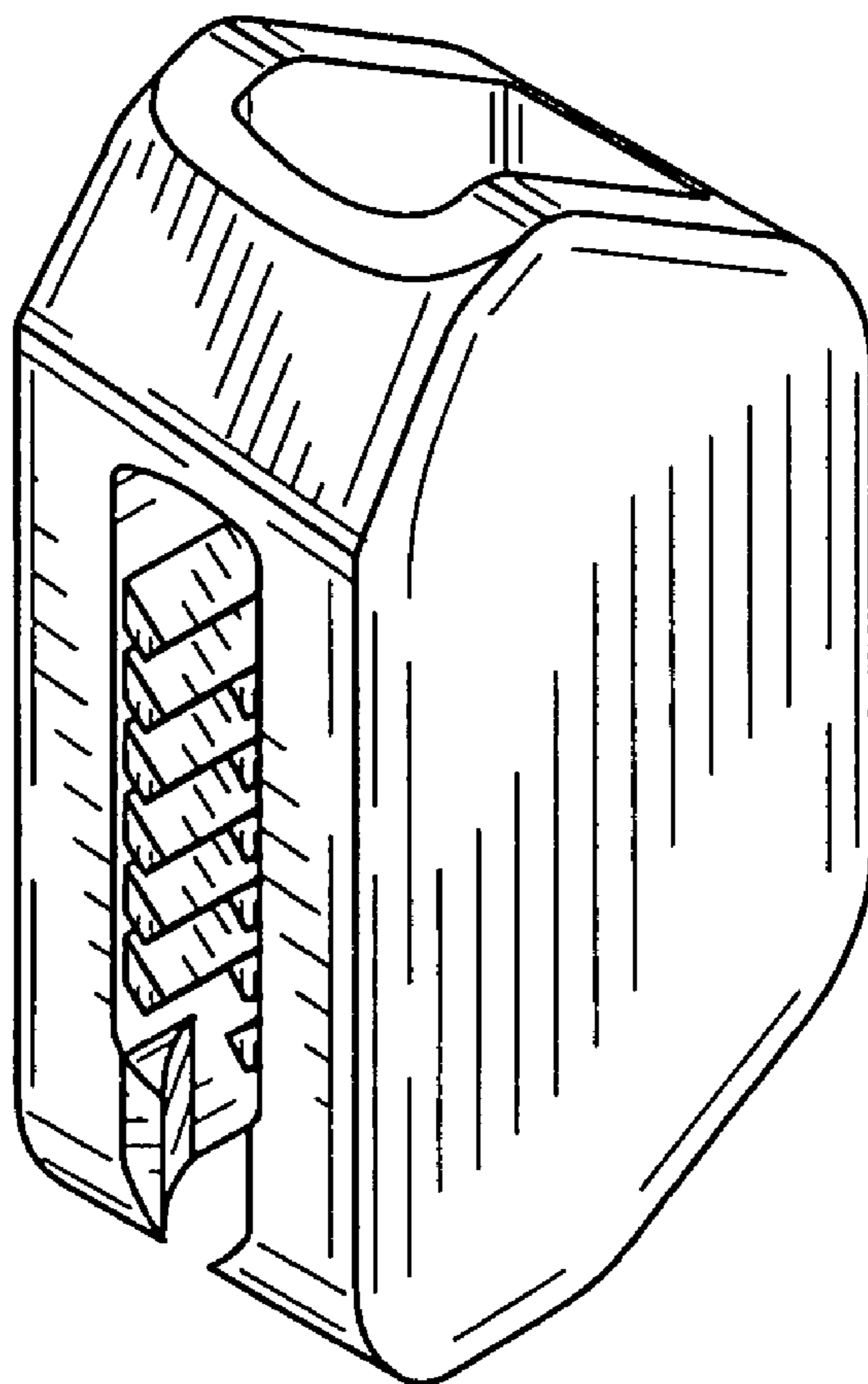

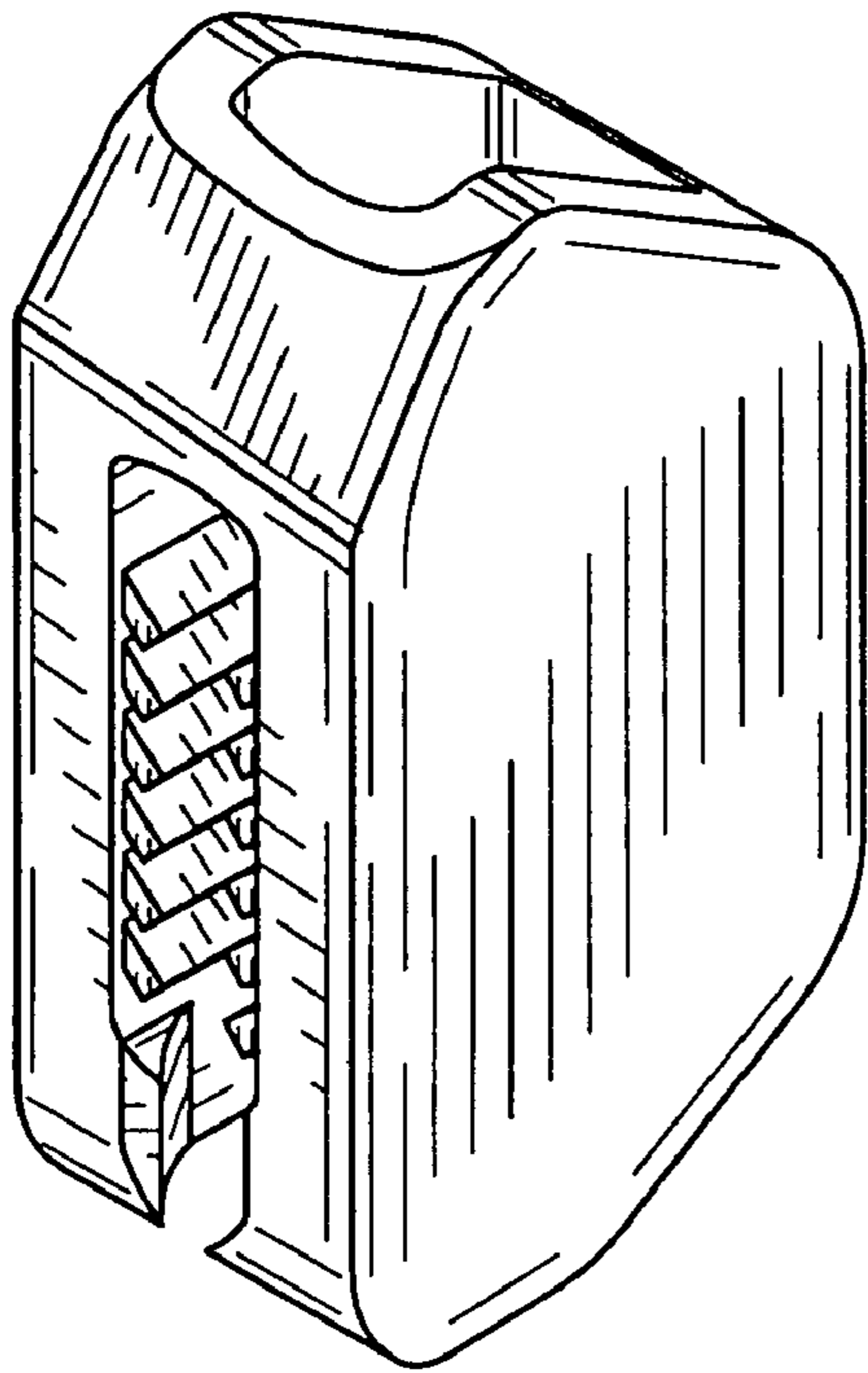

Fig. 1

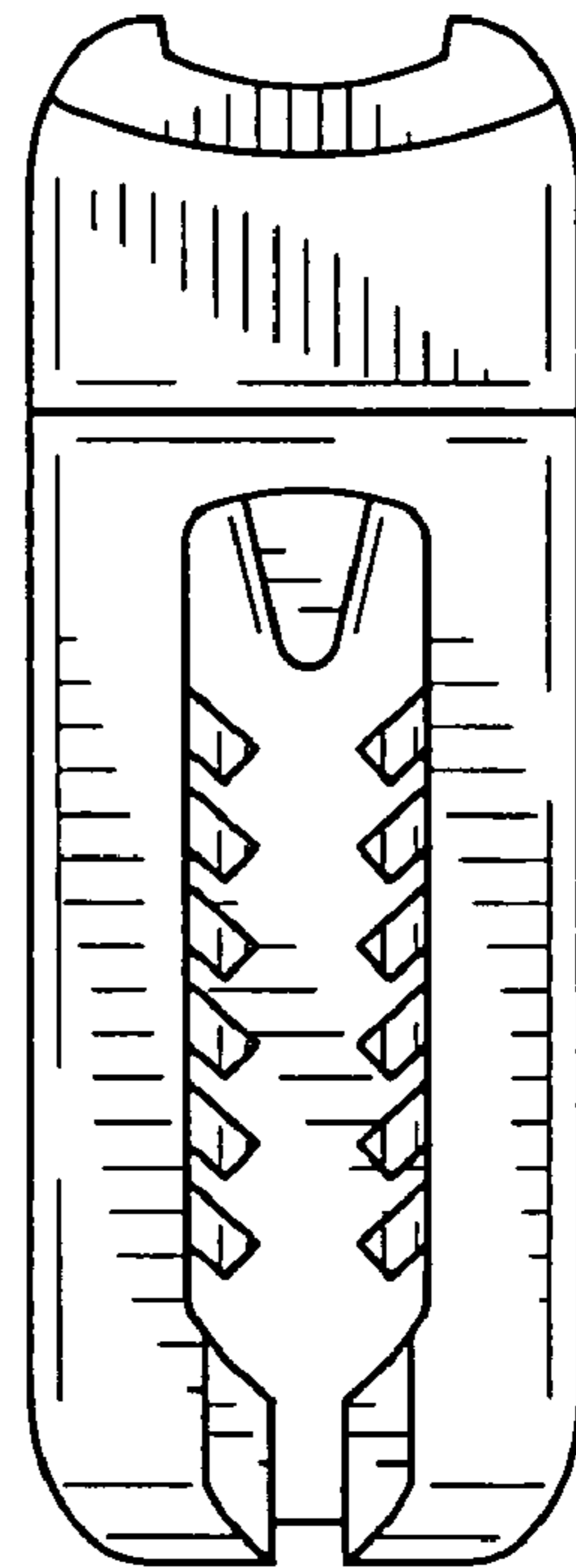

Fig. 2

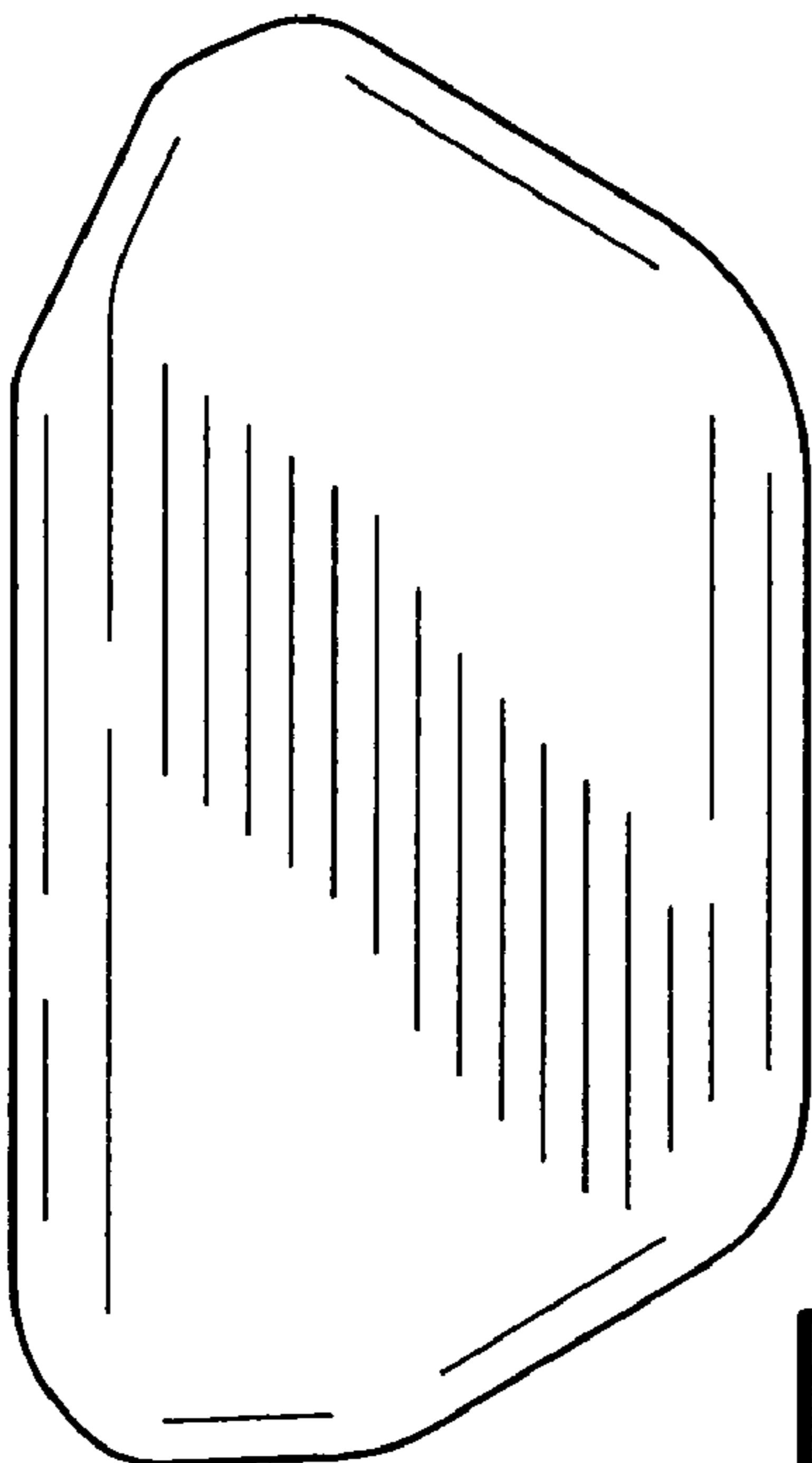

Fig. 3

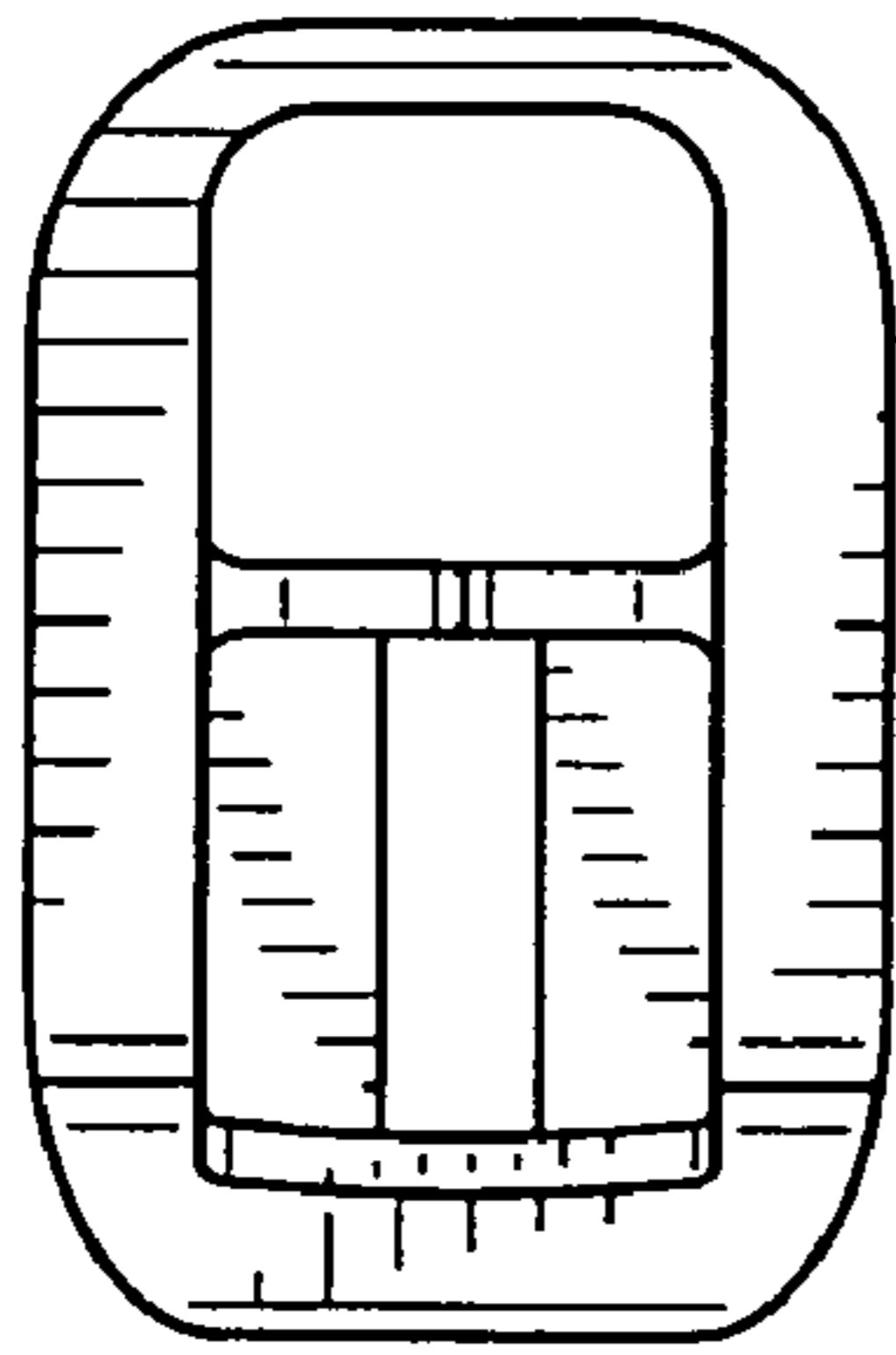

Fig. 4

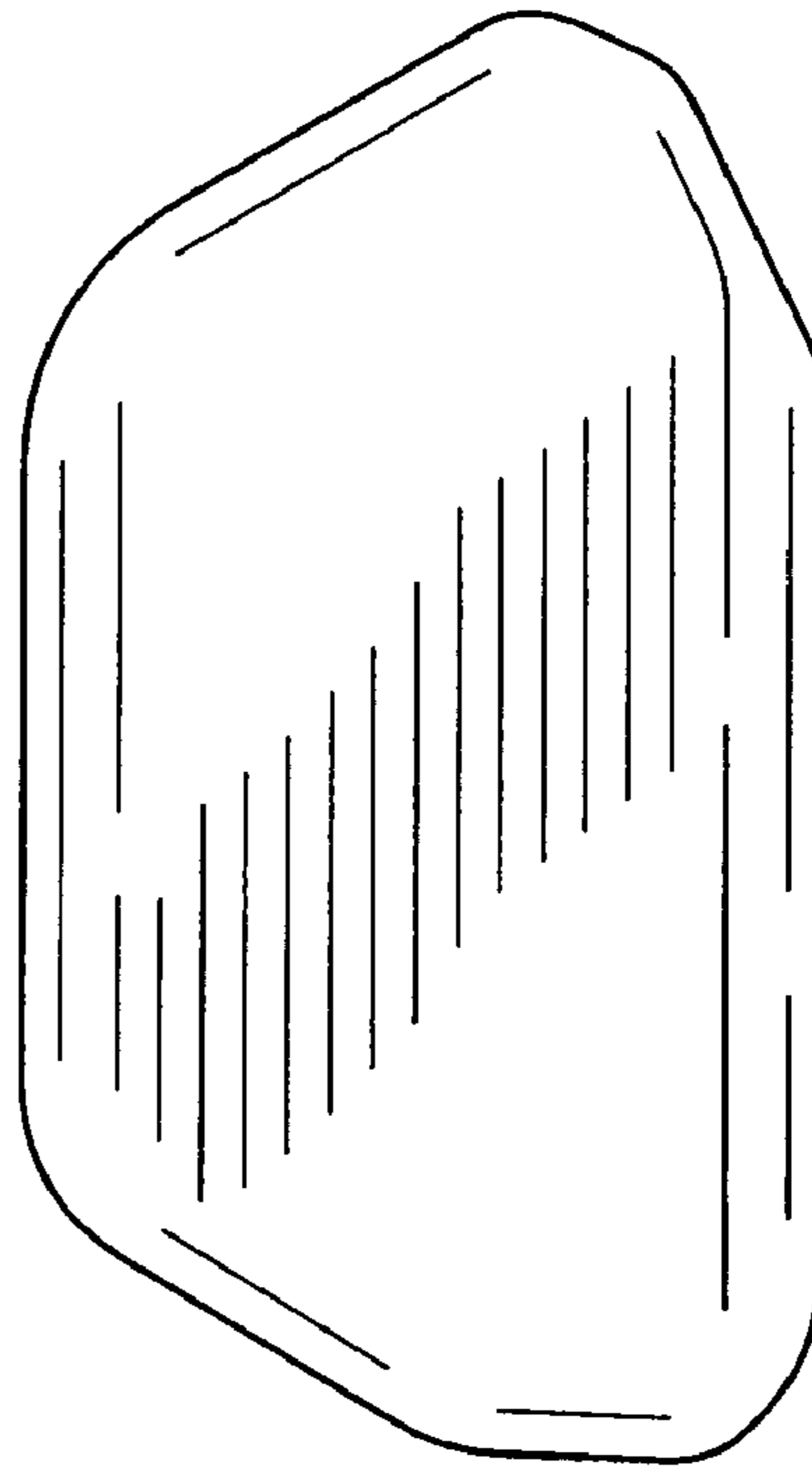

Fig. 5

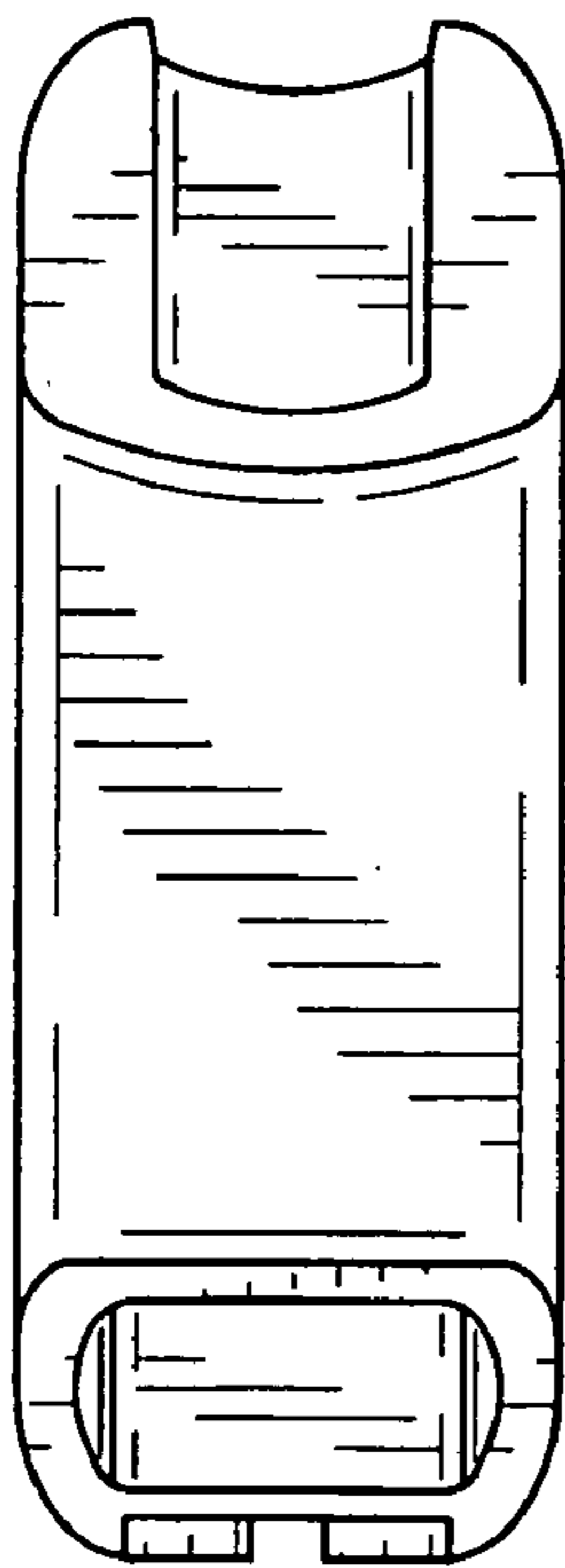

Fig. 6

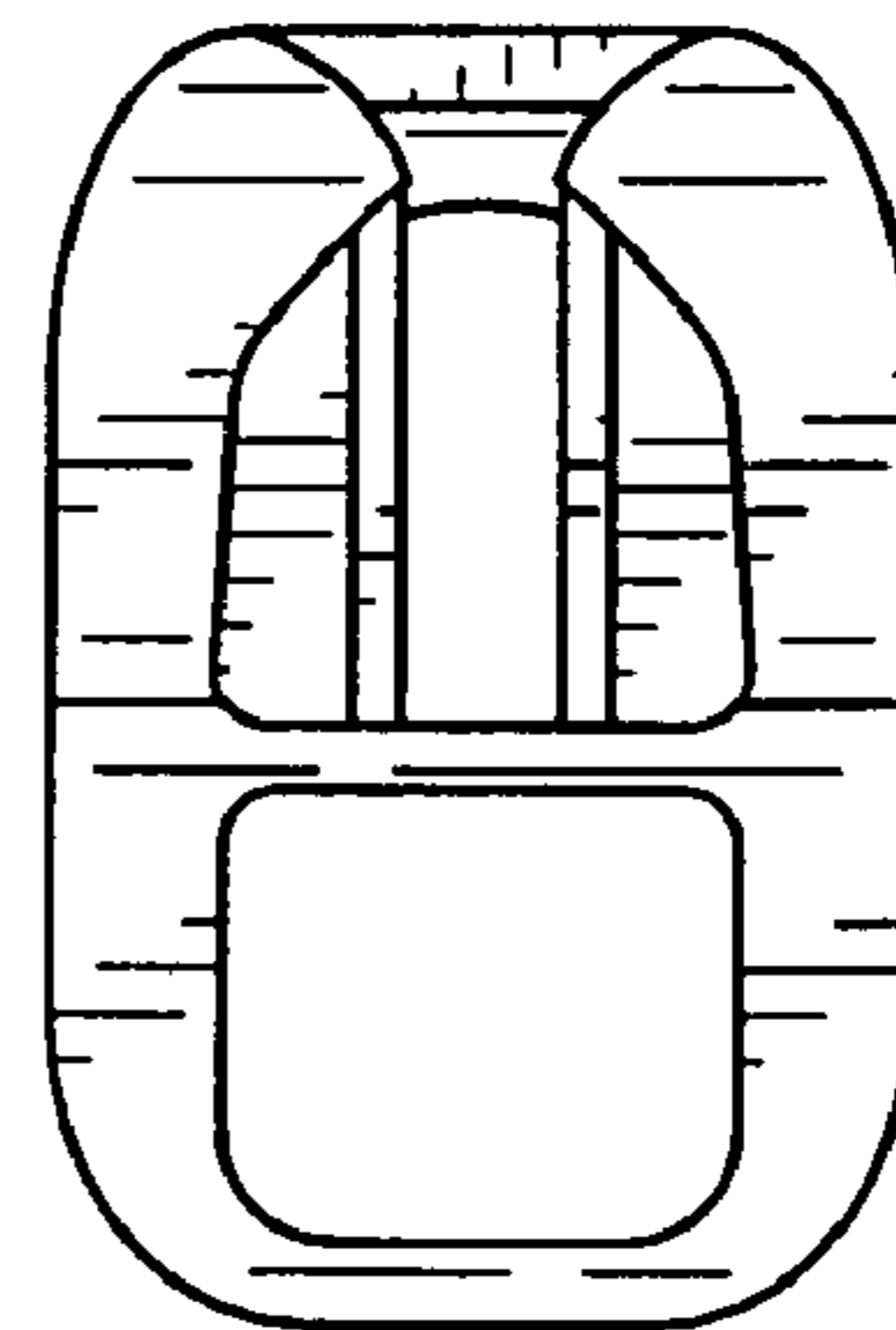

Fig. 7

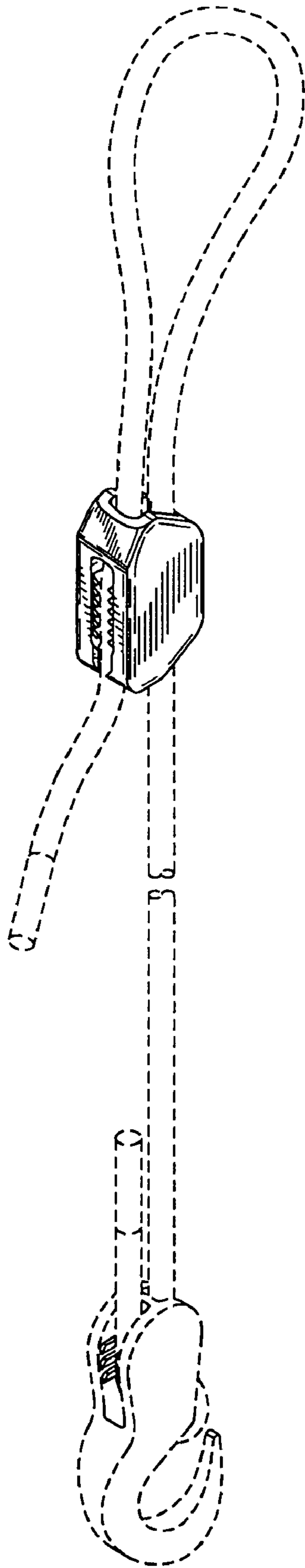

Fig. 8