



US00D635419S

(12) **United States Design Patent**
Chen

(10) **Patent No.:** **US D635,419 S**

(45) **Date of Patent:** **** Apr. 5, 2011**

(54) **HAND TOOL**

(76) Inventor: **Shu-Ju Chen**, Taichung (TW)

(**) Term: **14 Years**

(21) Appl. No.: **29/376,979**

(22) Filed: **Oct. 15, 2010**

(51) **LOC (9) Cl.** **08-05**

(52) **U.S. Cl.** **D8/25; D8/29**

(58) **Field of Classification Search** D8/21-29,
D8/40, 42, 98; 81/58.3-59.16, 177.1, 177.85,
81/121.1, 124.3, 165-170, 110.1, 176.2,
81/124.6, 176.1, 176.15, 60, 62, 177.2; 16/110.1;
D15/144.1; 219/75, 227, 229, 121.16, 121.18
See application file for complete search history.

(56) **References Cited**

U.S. PATENT DOCUMENTS

D271,937	S	*	12/1983	Combs	D8/83
D292,771	S	*	11/1987	Kim	D8/25
D387,964	S	*	12/1997	Urvoy	D8/83
D400,430	S	*	11/1998	McDonough et al.	D8/387
6,079,298	A	*	6/2000	Gasperi et al.	81/63.1
6,138,531	A	*	10/2000	Lamons	81/60

D470,369	S	*	2/2003	Byram et al.	D8/25
D472,947	S	*	4/2003	Wu	D21/694
D496,845	S	*	10/2004	Smeja et al.	D8/107
7,240,527	B2	*	7/2007	Boyd	70/456 R
7,448,300	B2	*	11/2008	Barniak, Jr.	81/124.2

* cited by examiner

Primary Examiner — Raphael Barkai

Assistant Examiner — Randall Gholson

(74) *Attorney, Agent, or Firm* — Alan Kamrath; Kamrath & Associates PA

(57) **CLAIM**

The ornamental design for hand tool, as shown and described.

DESCRIPTION

FIG. 1 is a perspective view of a hand tool showing our new design;
FIG. 2 is a front view thereof;
FIG. 3 is a rear view thereof;
FIG. 4 is a left view thereof;
FIG. 5 is a right view thereof;
FIG. 6 is a top view thereof; and,
FIG. 7 is a bottom view thereof.

1 Claim, 7 Drawing Sheets

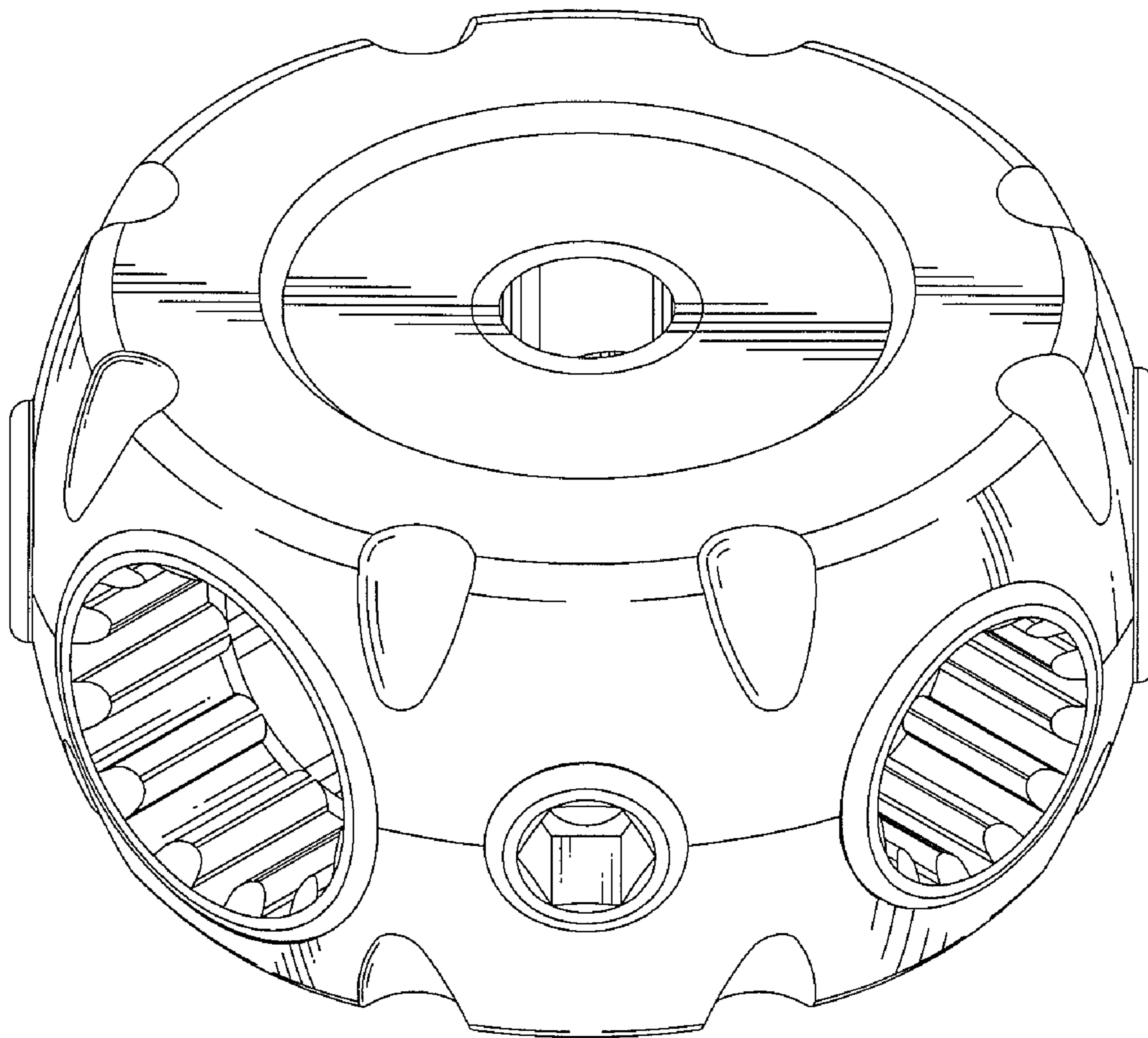
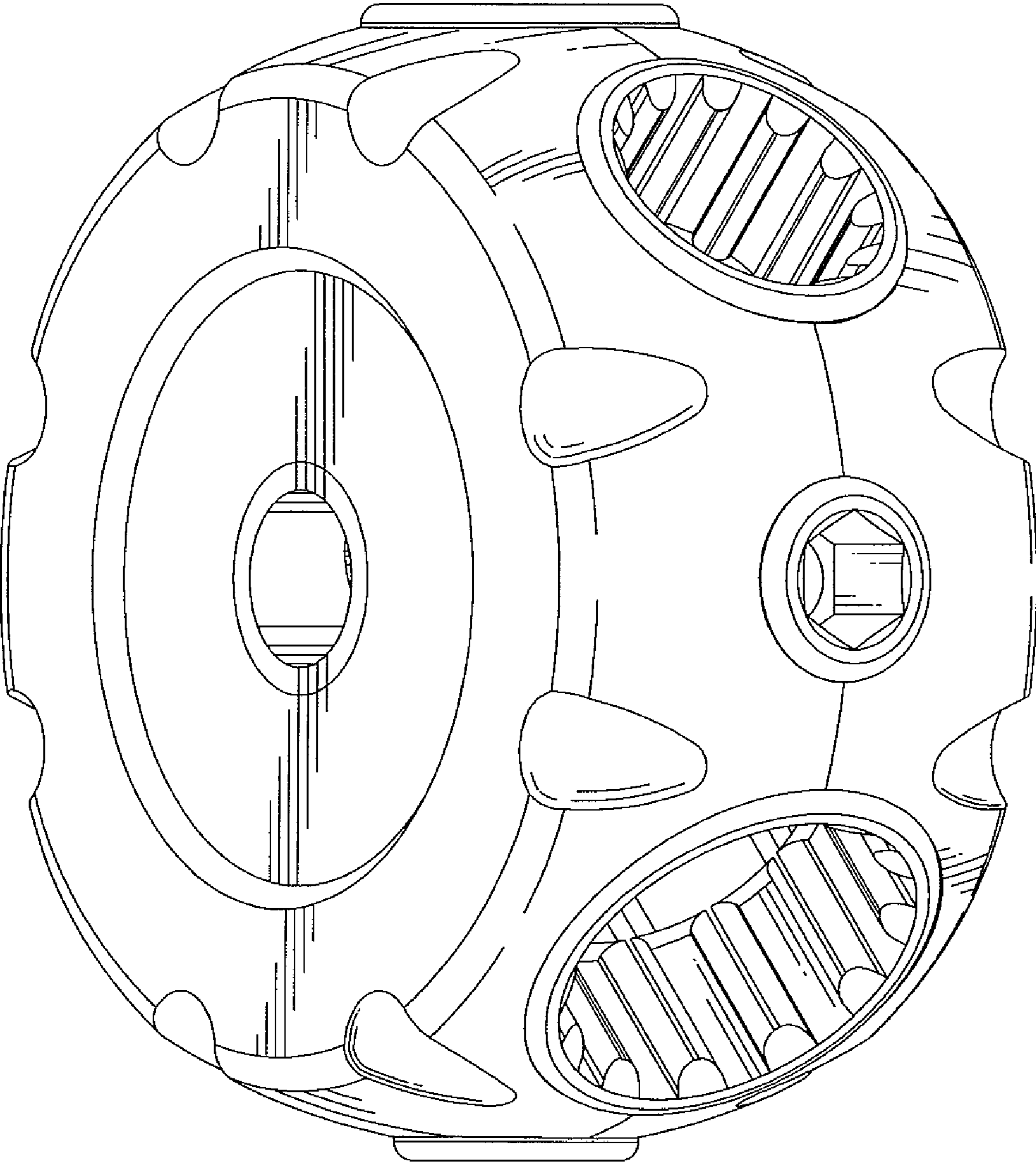

FIG. 1



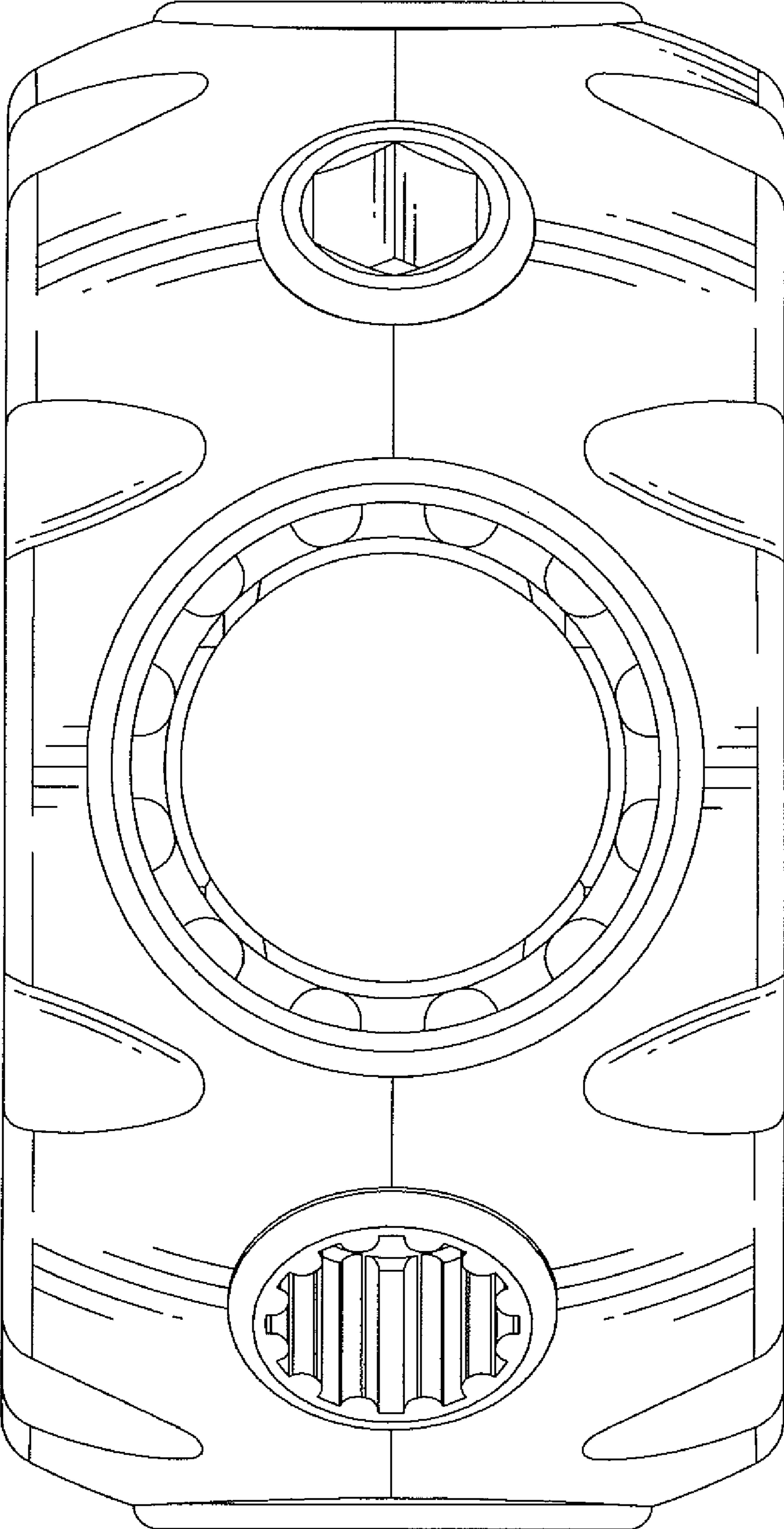

FIG.2

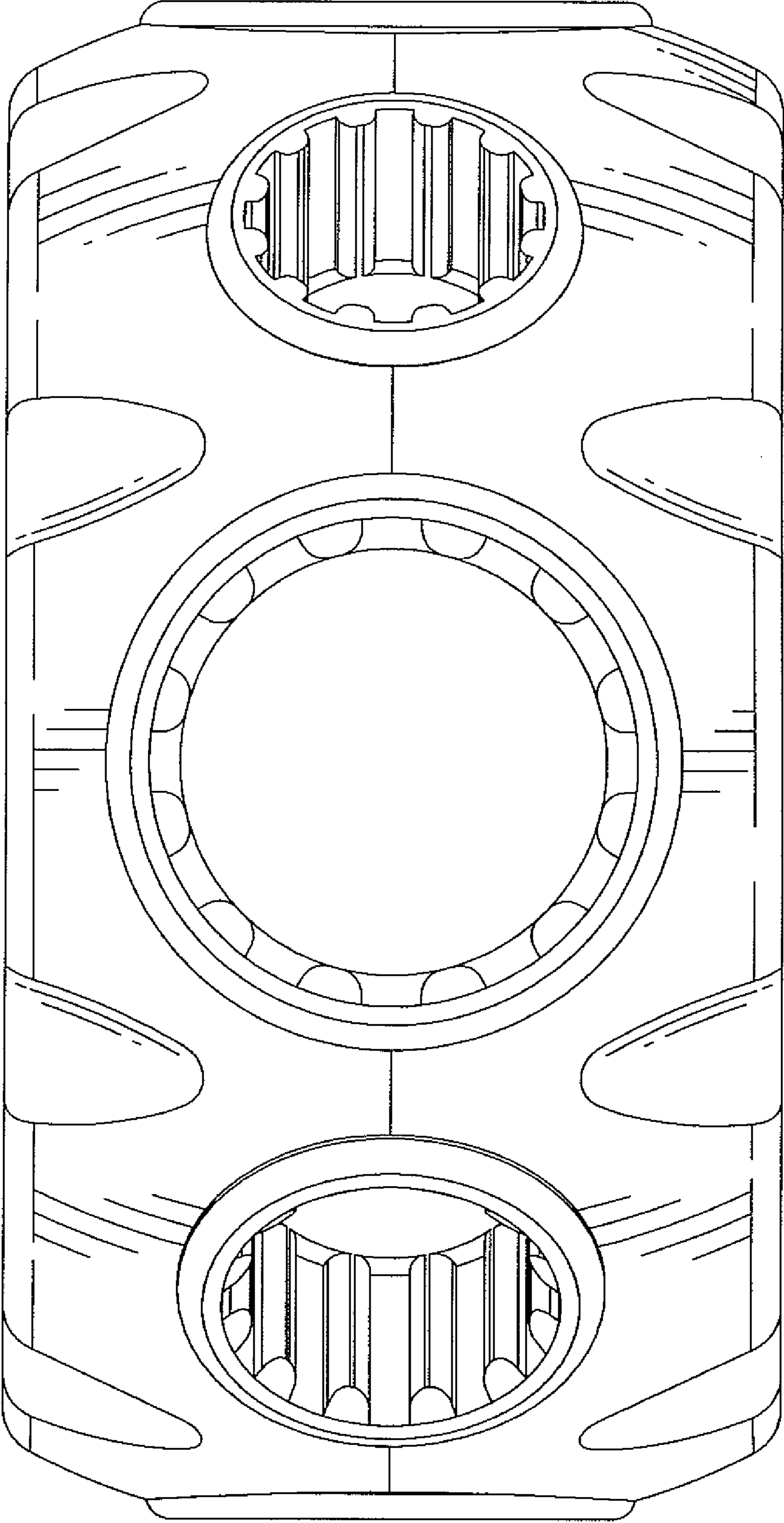

FIG.3

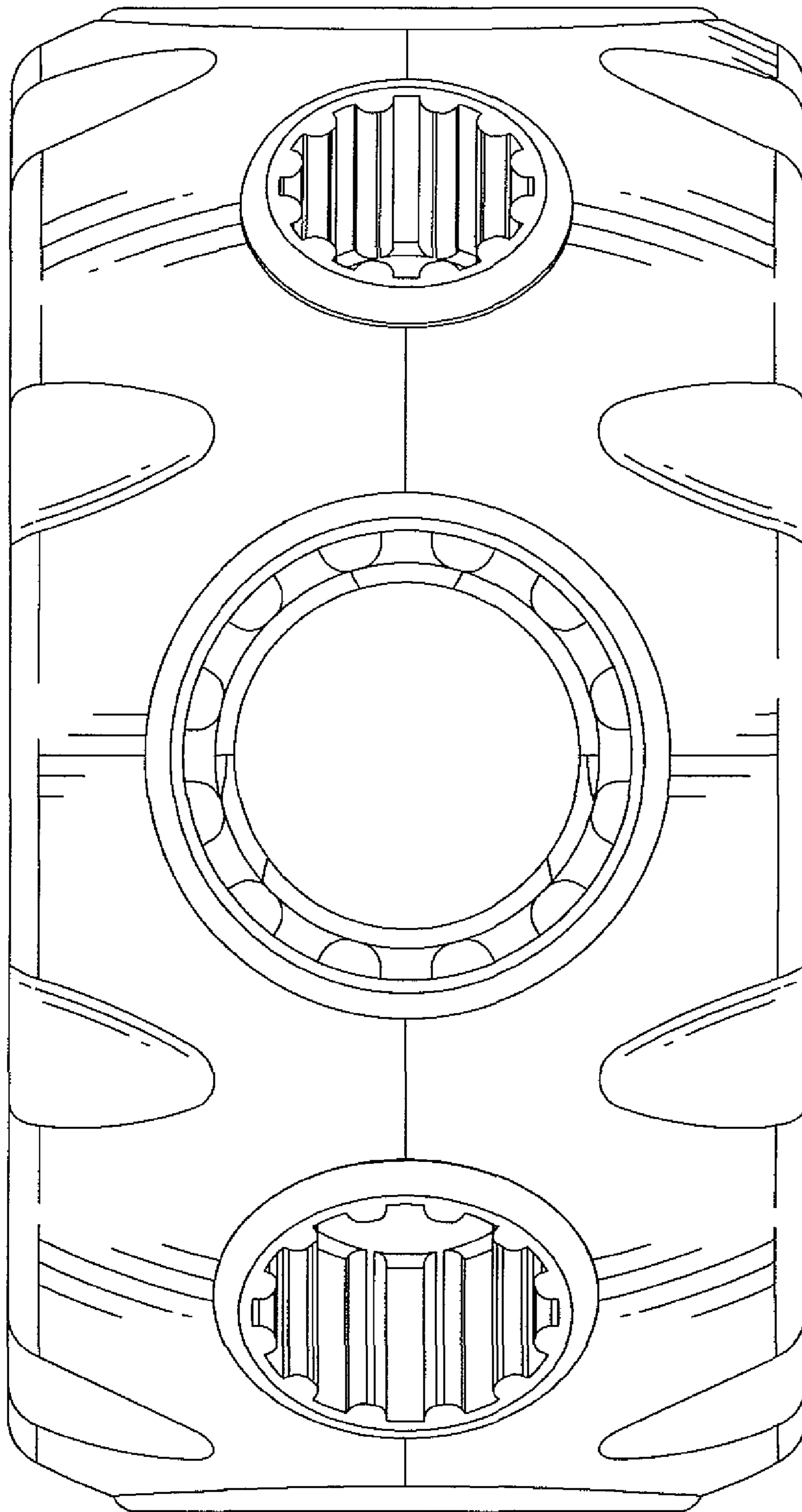

FIG.4

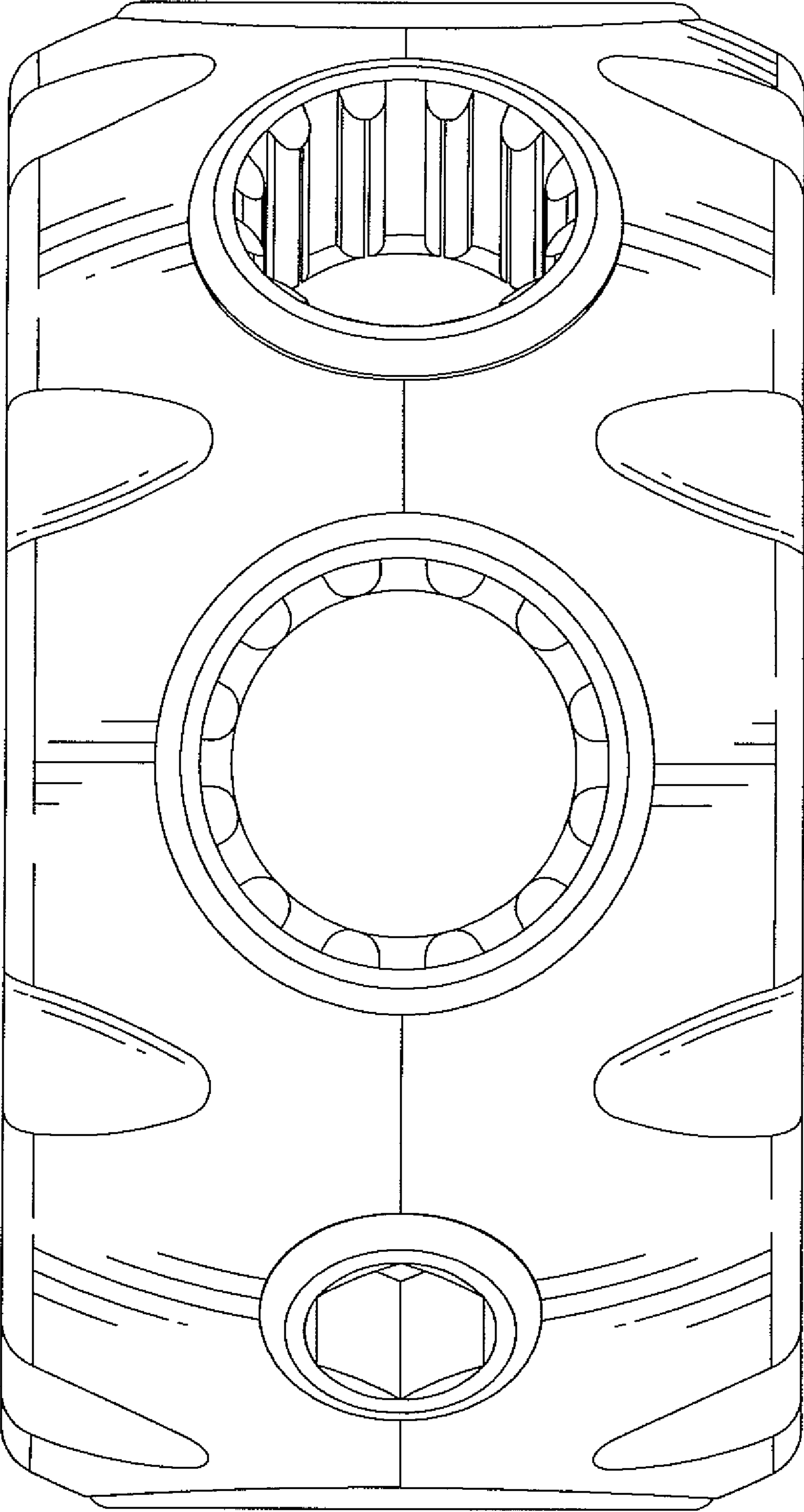

FIG.5

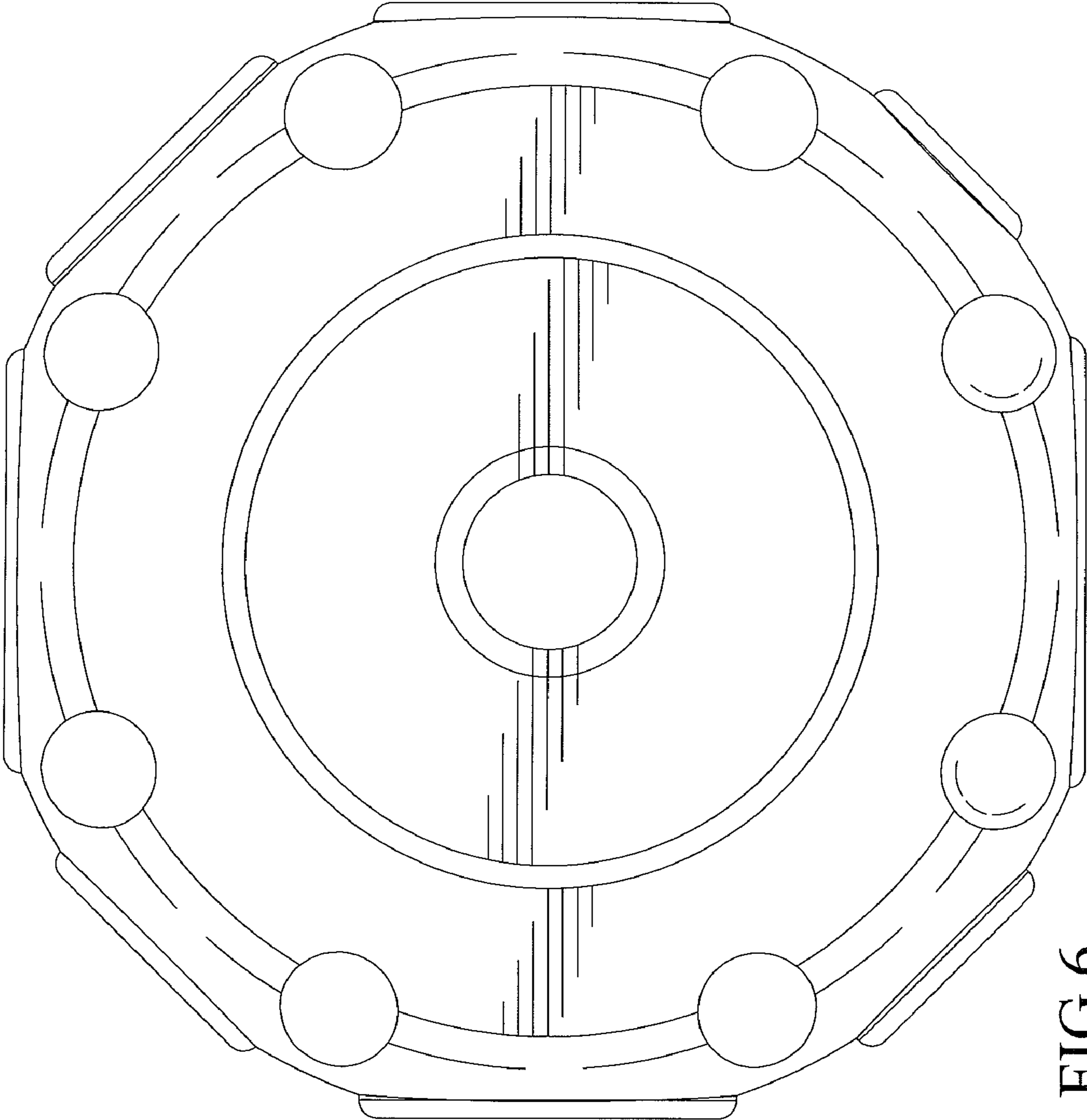

FIG.6

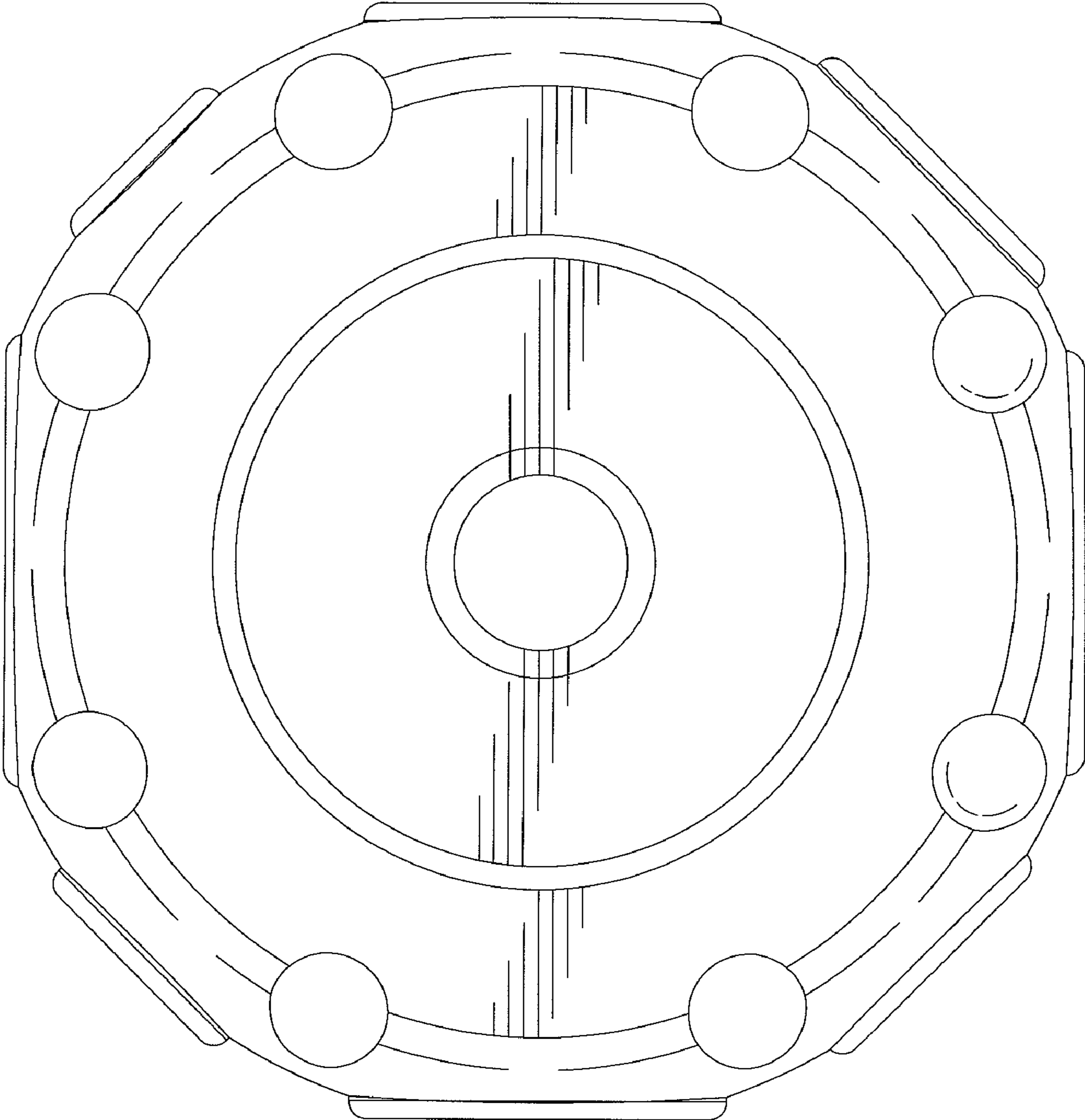

FIG. 7