



US00D635305S

(12) **United States Design Patent**
Lebel et al.

(10) **Patent No.:** **US D635,305 S**
(45) **Date of Patent:** **** Mar. 29, 2011**

(54) **HELMET ASSEMBLY**

(75) Inventors: **Stéphane Lebel**, Saint-Rédempteur (CA); **Marie-Pierre Gendron**, Châteauguay (CA); **Martin Bélanger**, Québec (CA); **Richard Coomber**, Montréal (CA); **Stéphan Morency**, Montréal (CA)

(73) Assignee: **Recision Eyewear, inc.**, Montreal, Quebec (CA)

(**) Term: **14 Years**

(21) Appl. No.: **29/342,925**

(22) Filed: **Sep. 3, 2009**

(51) **LOC (9) Cl.** **02-03**

(52) **U.S. Cl.** **D29/102**

(58) **Field of Classification Search** D29/102-107, D29/109, 111, 122; 2/6.1, 6.3, 6.5, 6.7, 414, 2/421-425, 427, 468, 209.13, 175.6, 184.5, 2/10; D2/882, 886, 893

See application file for complete search history.

(56) **References Cited**

U.S. PATENT DOCUMENTS

D207,900 S * 6/1967 Feldmann et al. D29/105
D268,220 S * 3/1983 Gooding D29/105
D283,940 S * 5/1986 Bally D29/107

5,687,427 A 11/1997 Lamattina
D510,644 S * 10/2005 Batstone D29/107
D521,688 S * 5/2006 Makris et al. D29/107
D527,847 S * 9/2006 Broersma D29/105
D536,833 S * 2/2007 Broersma D29/107
D601,308 S * 9/2009 Broersma D29/122
2002/0148033 A1 * 10/2002 Dufresne 2/424
2007/0083967 A1 4/2007 Crossman et al.
2009/0126059 A1 5/2009 Tack
2009/0144872 A1 * 6/2009 Lebel et al. 2/6.7
2009/0229043 A1 * 9/2009 Cyr 2/422

* cited by examiner

Primary Examiner — Ruth McInroy

(74) *Attorney, Agent, or Firm* — Erickson Law Group, PC

(57) **CLAIM**

The ornamental design for a helmet assembly, as shown and described.

DESCRIPTION

FIG. 1 is a perspective view of a helmet assembly; FIG. 2 is a right side view of the helmet assembly; FIG. 3 is a left side view of the helmet assembly; FIG. 4 is a rear view of the helmet assembly; FIG. 5 is a front view of the helmet assembly; FIG. 6 is a top view of the helmet assembly; and, FIG. 7 is a bottom view of the helmet assembly.

1 Claim, 7 Drawing Sheets

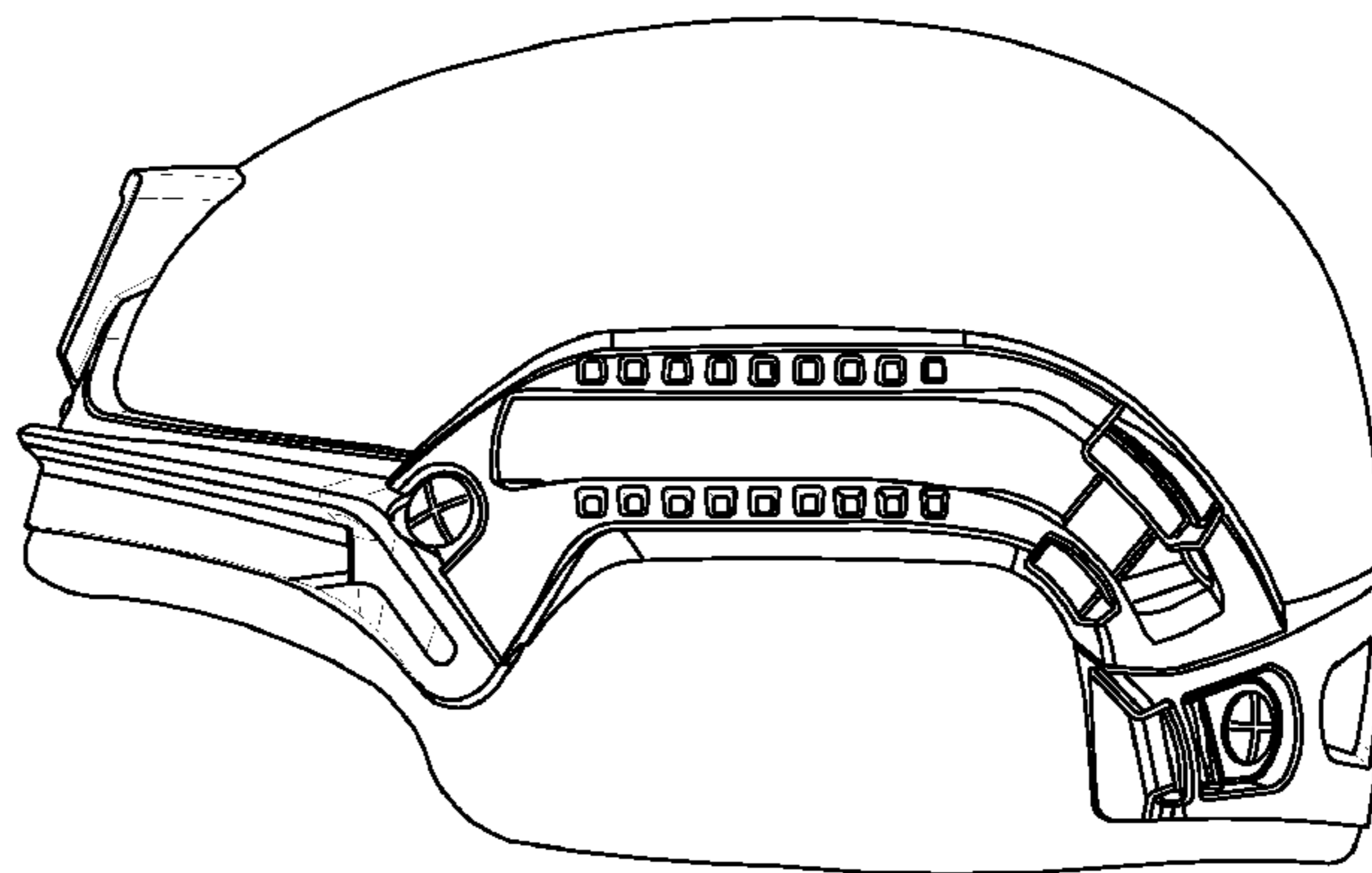
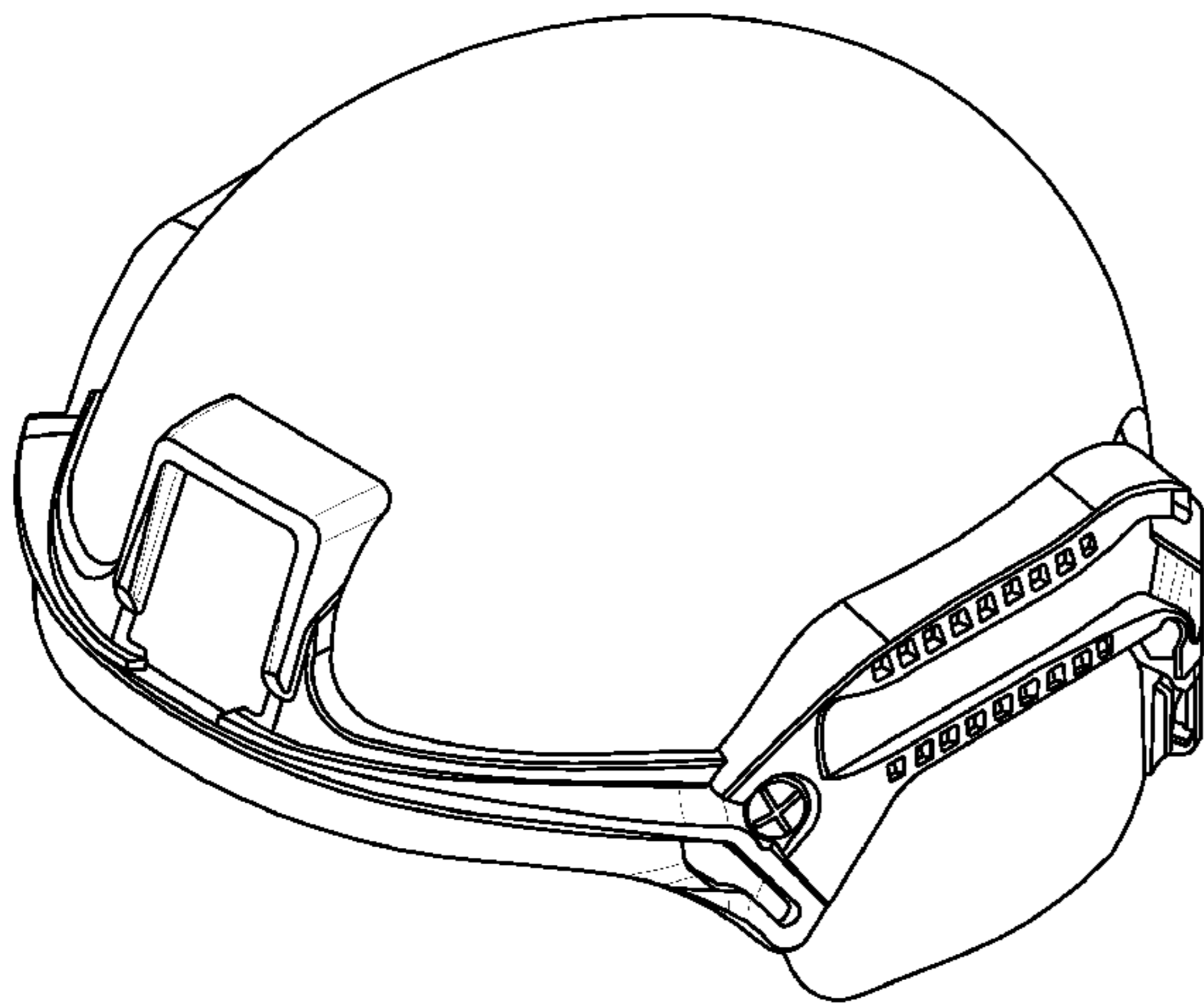

FIG. 1

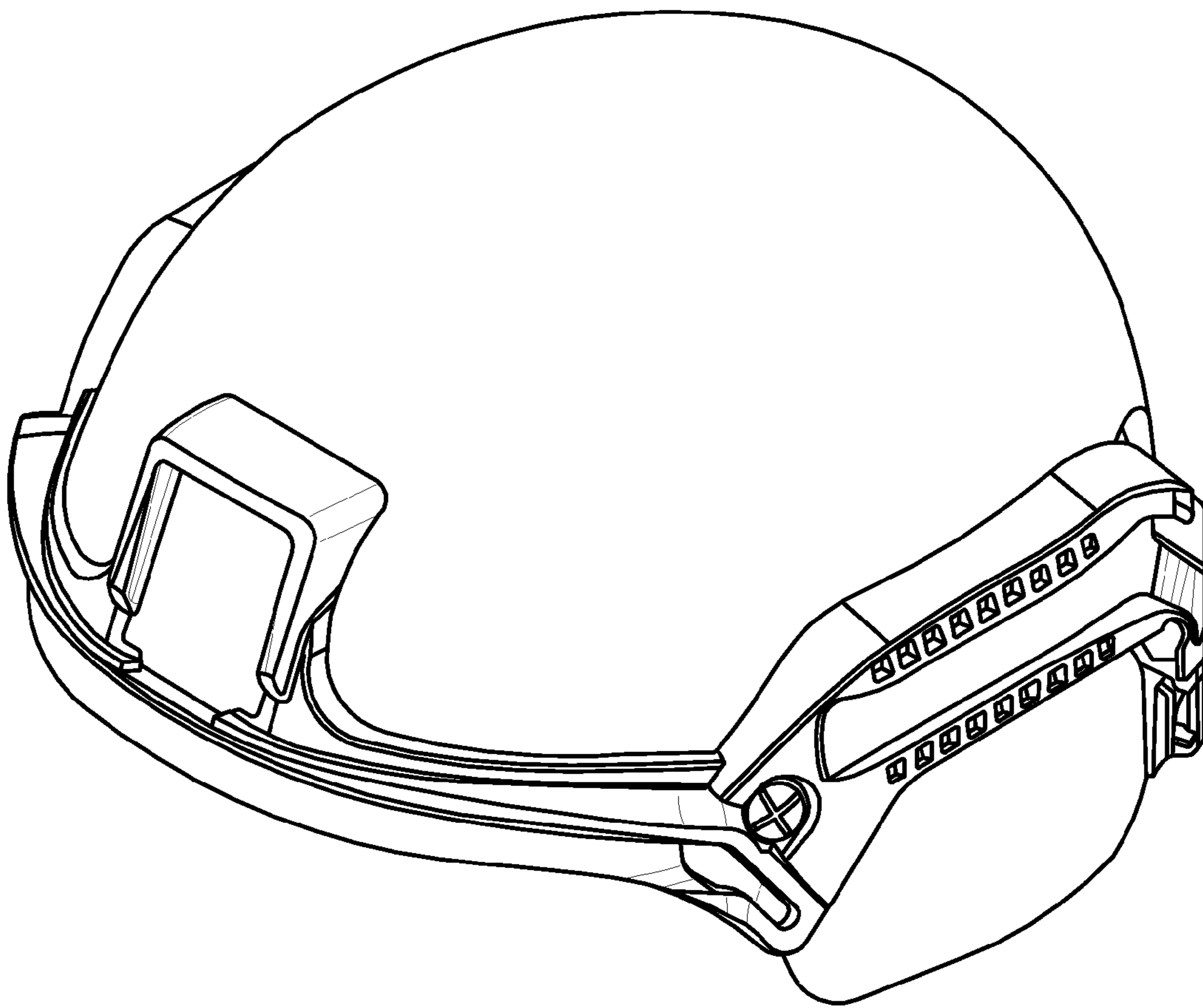

FIG. 2

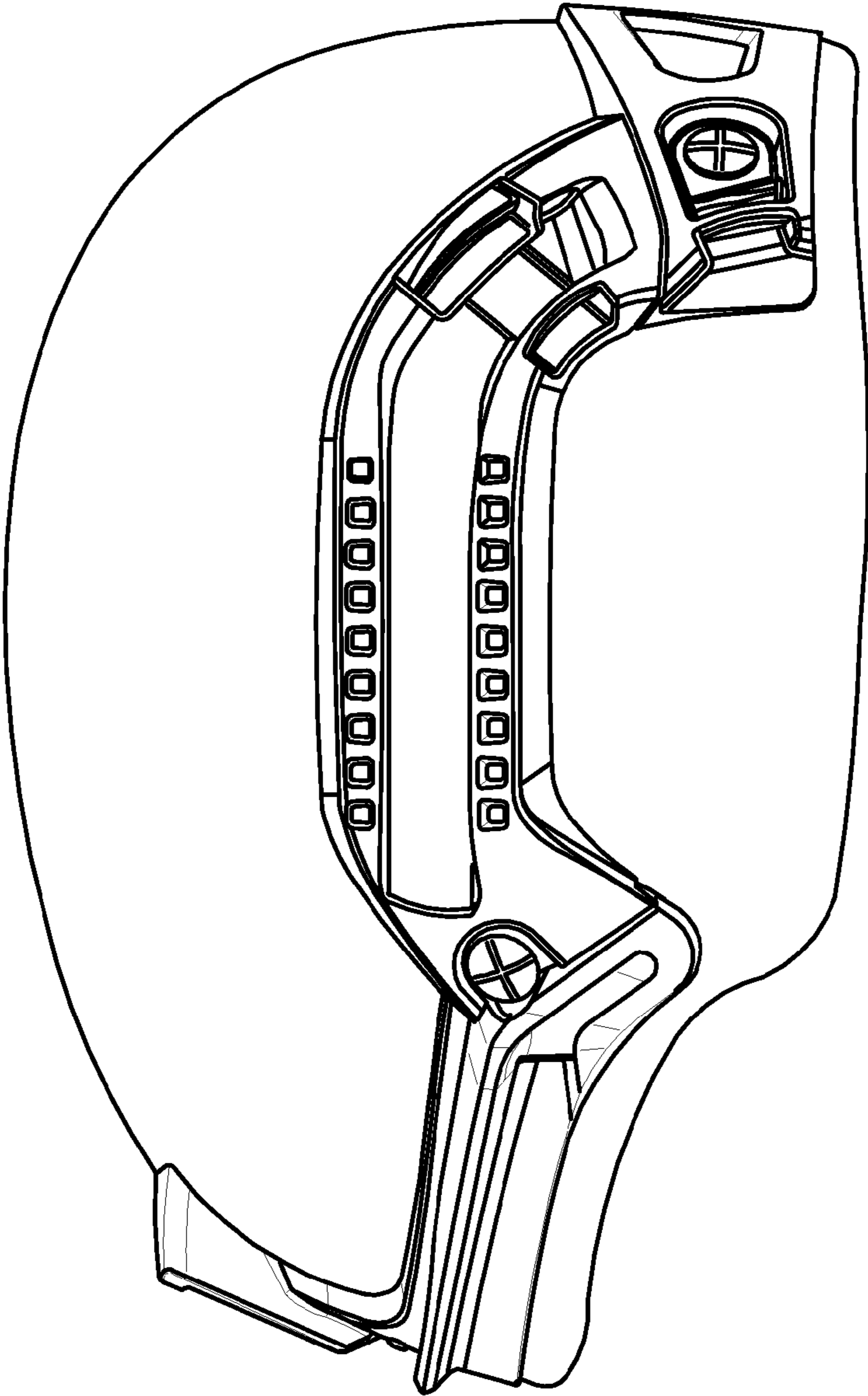

FIG. 3

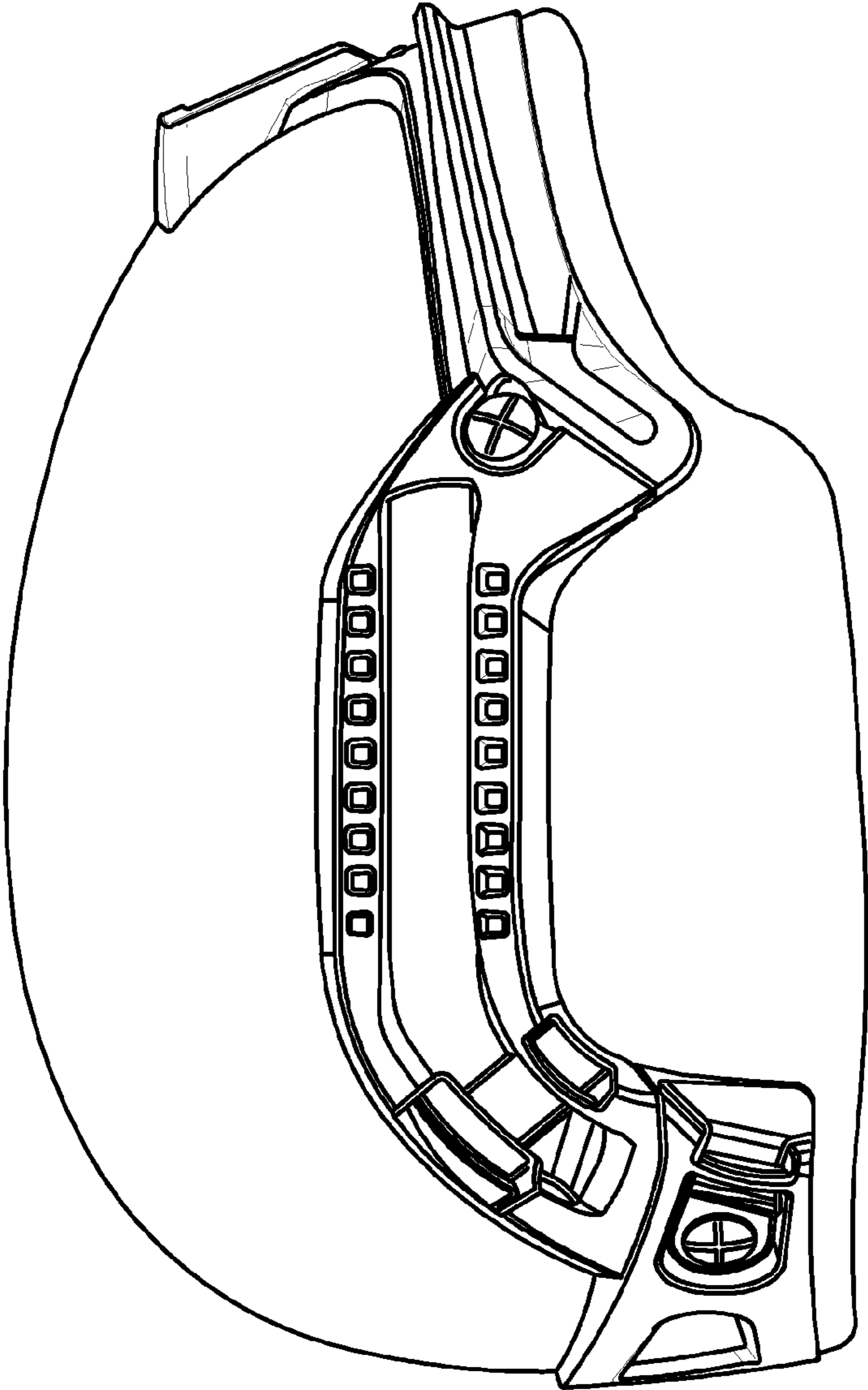

FIG. 4

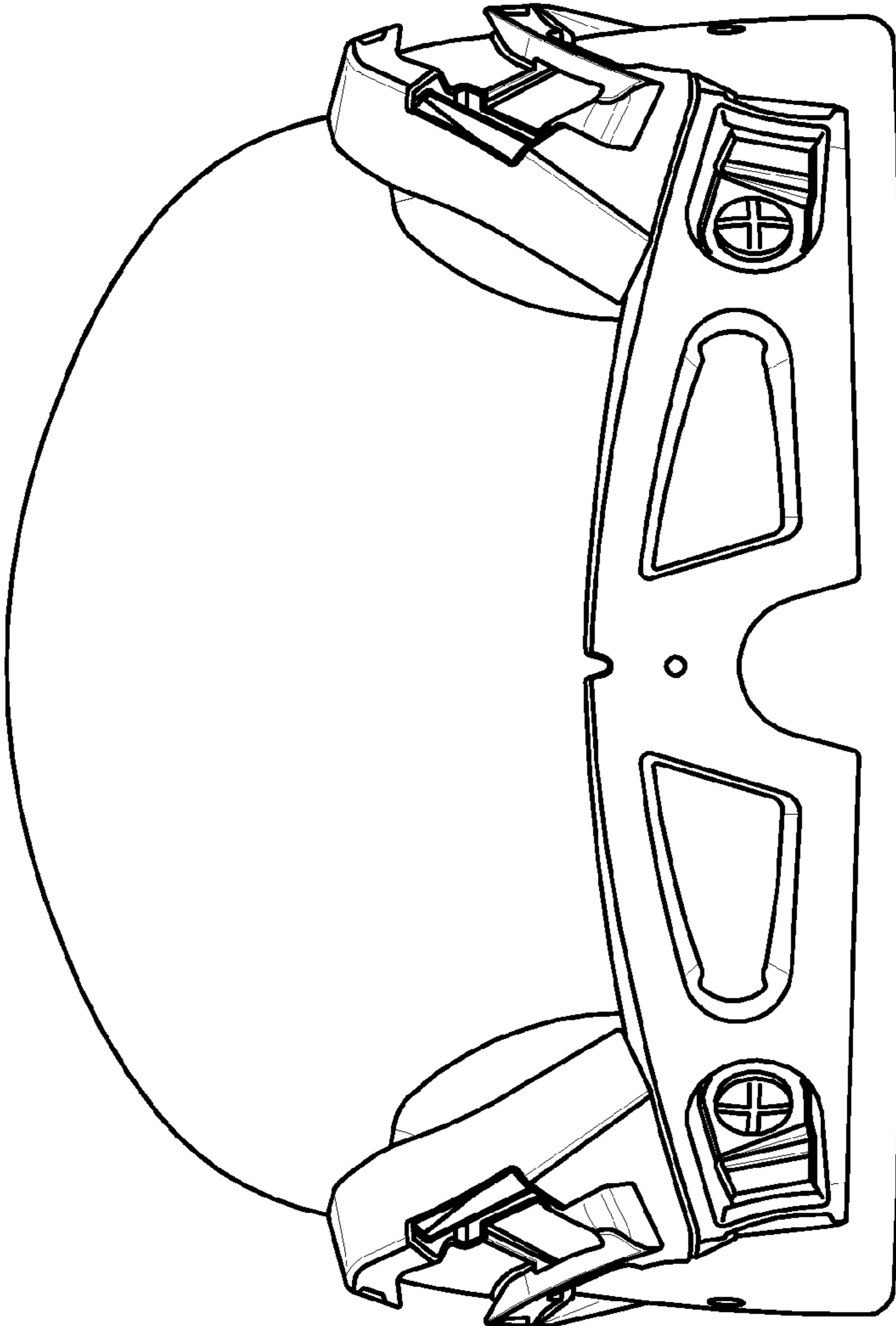

FIG. 5

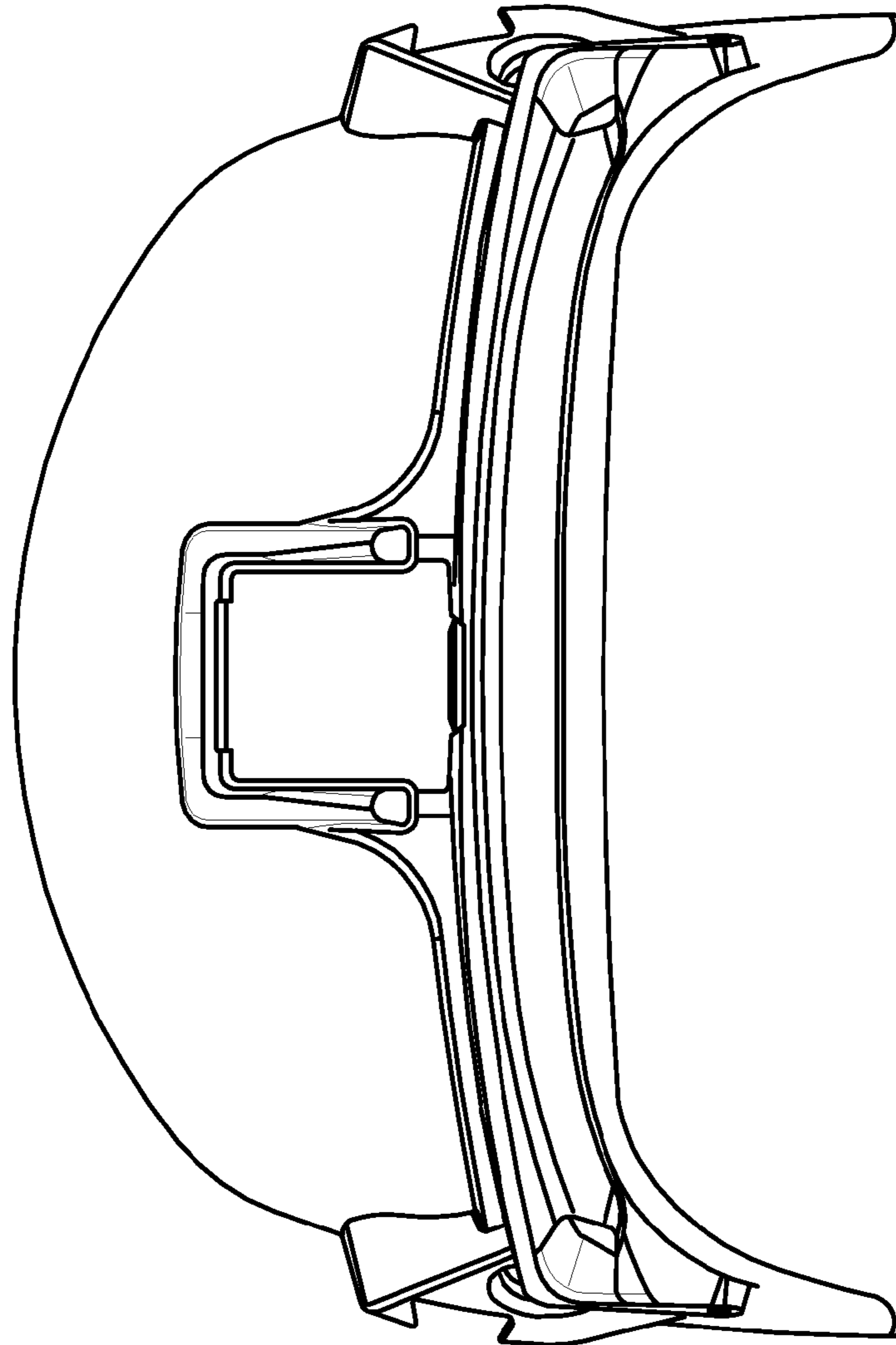

FIG. 6

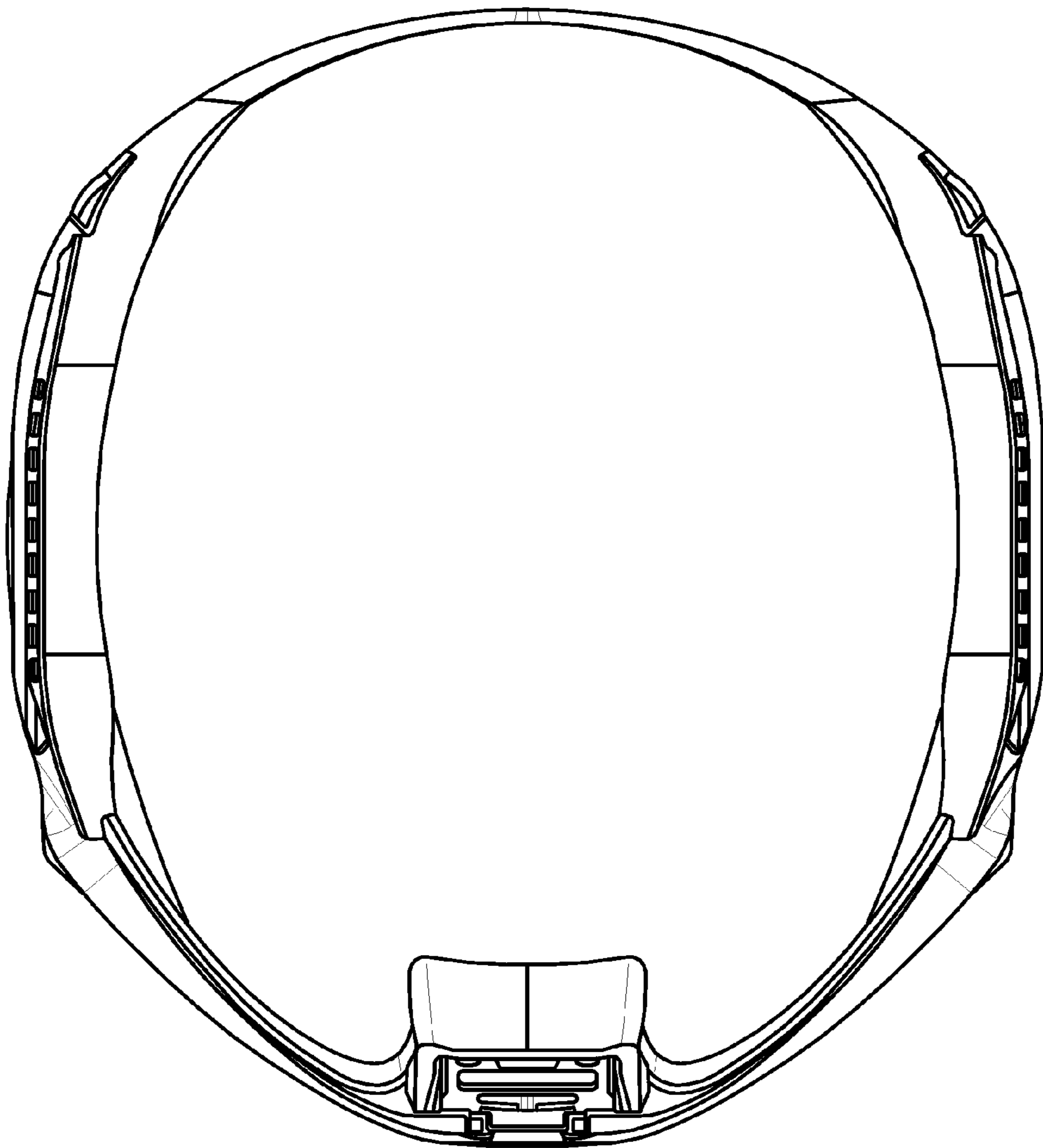

FIG. 7

