



US00D635202S

(12) **United States Design Patent**
Chang

(10) **Patent No.:** **US D635,202 S**
(45) **Date of Patent:** **** Mar. 29, 2011**

- (54) **VIBRATION MACHINE**
 - (75) Inventor: **Chang-Chi Chang**, Taichung (TW)
 - (73) Assignee: **Quin Form Industrial Co., Ltd.**,
Taichung (TW)
 - (**) Term: **14 Years**
 - (21) Appl. No.: **29/347,159**
 - (22) Filed: **Oct. 8, 2009**
 - (51) **LOC (9) Cl.** **21-02**
 - (52) **U.S. Cl.** **D21/662**
 - (58) **Field of Classification Search** D21/662,
D21/668, 671, 686, 688, 689; D24/200,
D24/215; 601/23, 49, 51, 66, 70, 90; 482/27,
482/51, 145, 146, 91
- See application file for complete search history.

- D591,366 S * 4/2009 Decommer D21/662
- D591,804 S * 5/2009 Tsuchida D21/662
- 7,530,960 B2 * 5/2009 Cook 601/46
- D599,862 S * 9/2009 Decommer D21/662
- D601,211 S * 9/2009 Wu D21/686
- D602,540 S * 10/2009 Minter D21/662
- D602,541 S * 10/2009 Iozzia D21/662
- 2007/0239088 A1 * 10/2007 Wu 601/49
- 2007/0290632 A1 * 12/2007 Stevens 318/37

* cited by examiner

Primary Examiner — Susan E Krakower

(74) *Attorney, Agent, or Firm* — Rosenberg, Klein & Lee

(57) **CLAIM**

The ornamental design for a vibration machine, as shown and described.

DESCRIPTION

FIG. 1 is a perspective view of a vibration machine showing my new design;

FIG. 2 is a front elevational view thereof;

FIG. 3 is a rear elevational view thereof;

FIG. 4 is a left side elevational view thereof;

FIG. 5 is a right side elevational view thereof;

FIG. 6 is a top plan view thereof; and,

FIG. 7 is a bottom plan view thereof.

The environmental elements of the disclosure shown in broken lines form no part of the claimed design.

1 Claim, 7 Drawing Sheets

(56) **References Cited**

U.S. PATENT DOCUMENTS

- 4,638,996 A * 1/1987 Simjian 482/147
- D380,508 S * 7/1997 Chang D21/688
- D518,533 S * 4/2006 van der Meer D21/662
- D538,358 S * 3/2007 Glier D21/662
- D559,924 S * 1/2008 Wu D21/661
- D561,273 S * 2/2008 Wu D21/662
- D574,900 S * 8/2008 Meile Marcel
Tamminga D21/662
- D586,468 S * 2/2009 Petersen D24/200
- D586,867 S * 2/2009 Wu D21/662

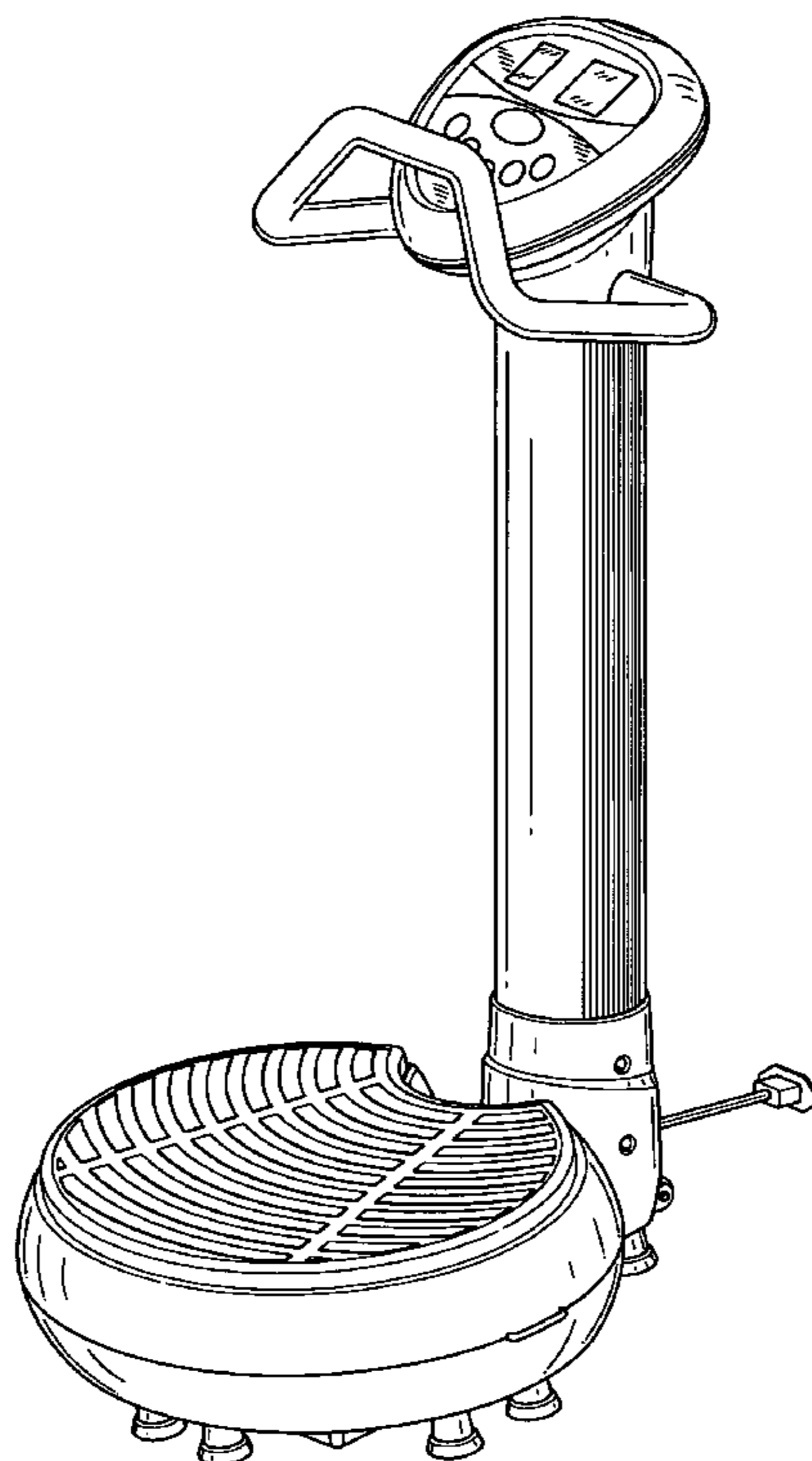

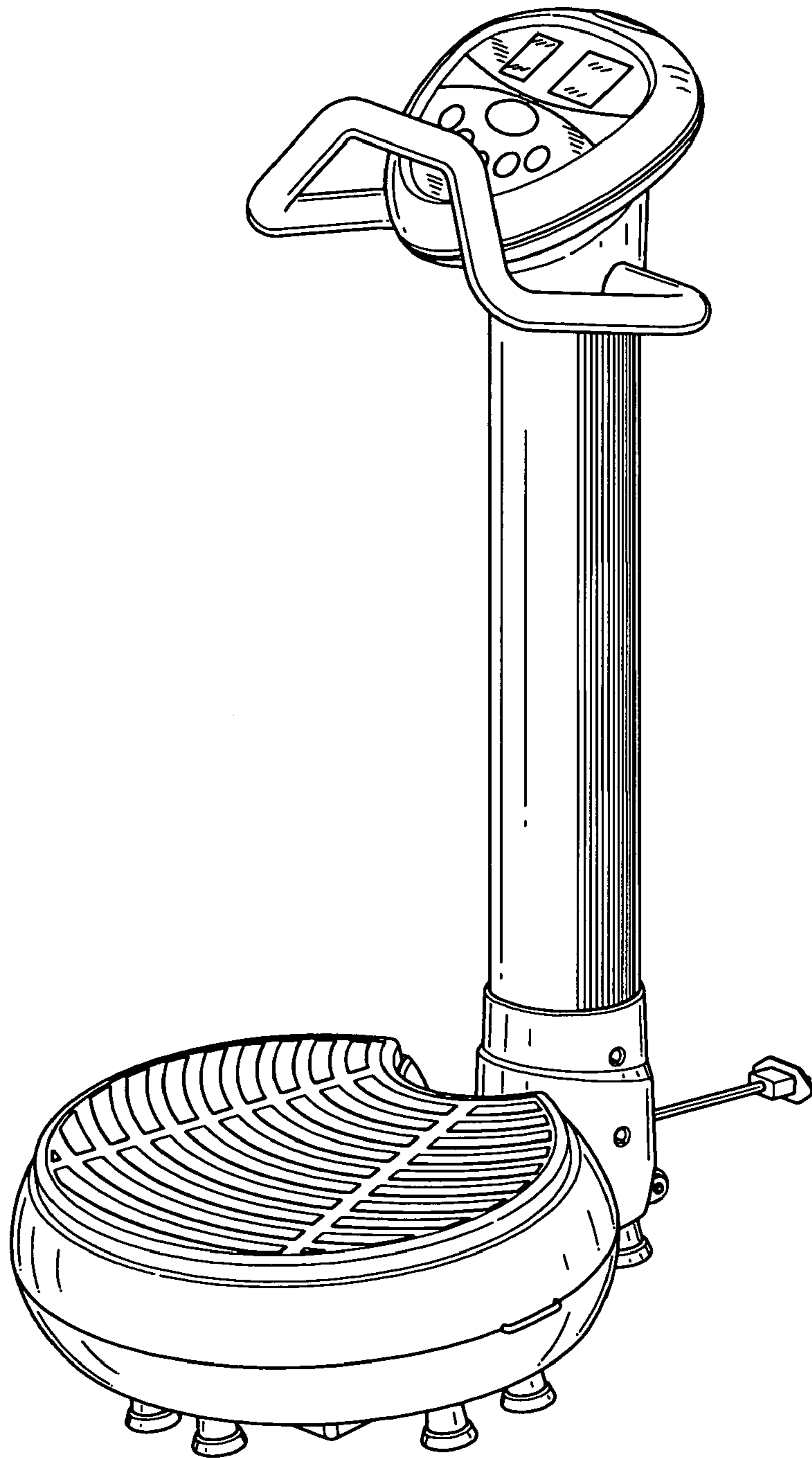

FIG. 1

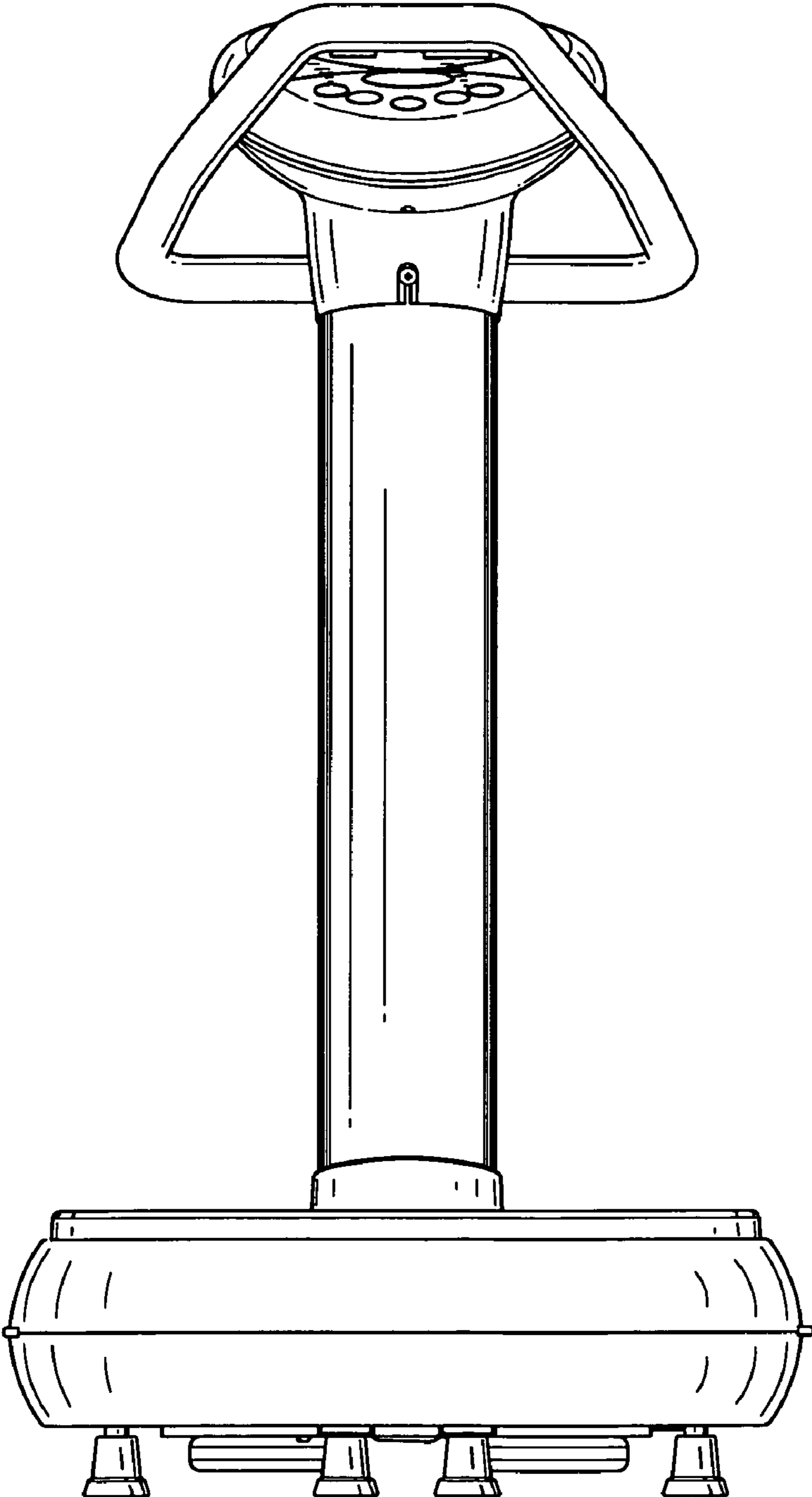

FIG.2

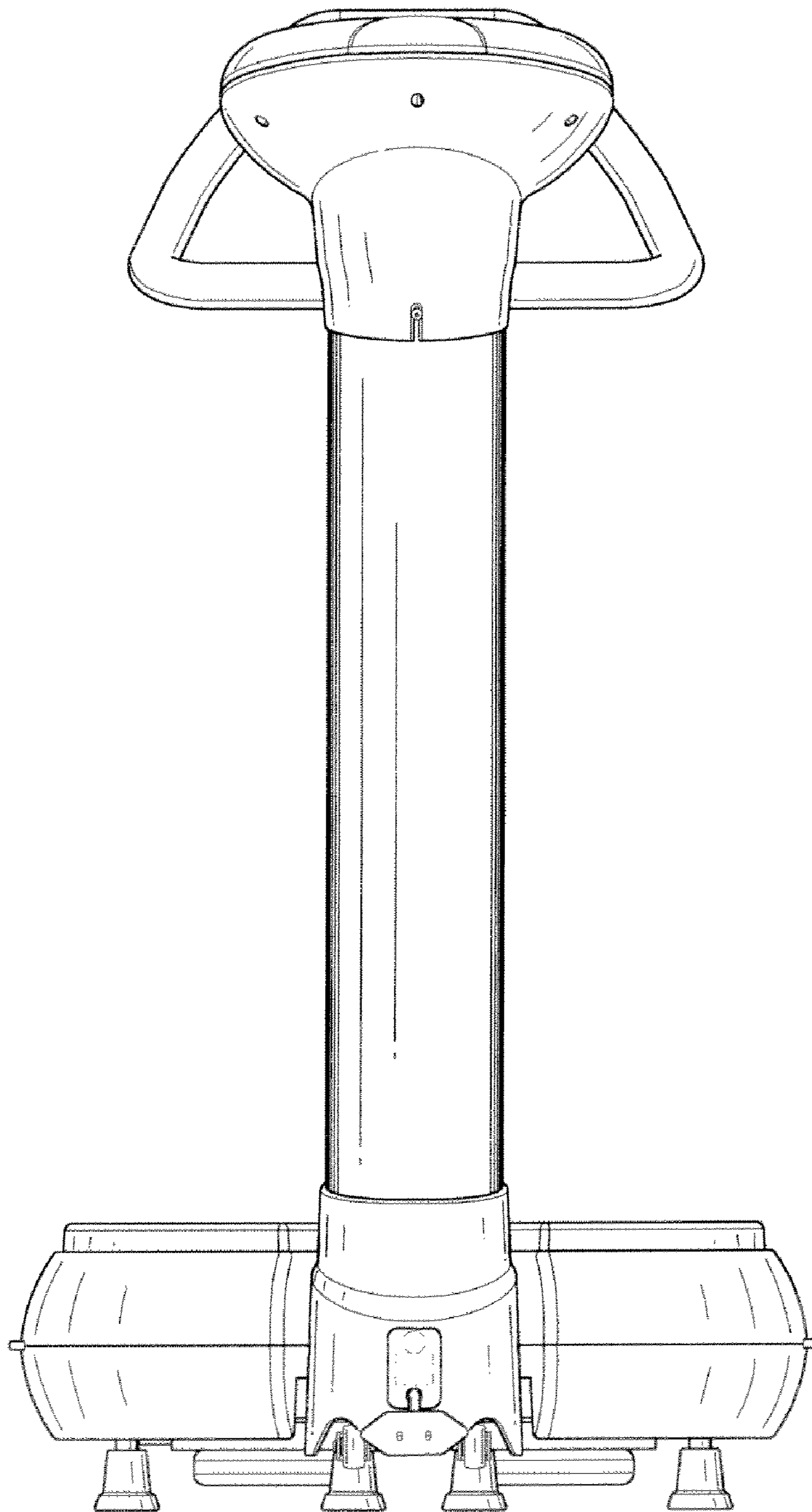

FIG.3

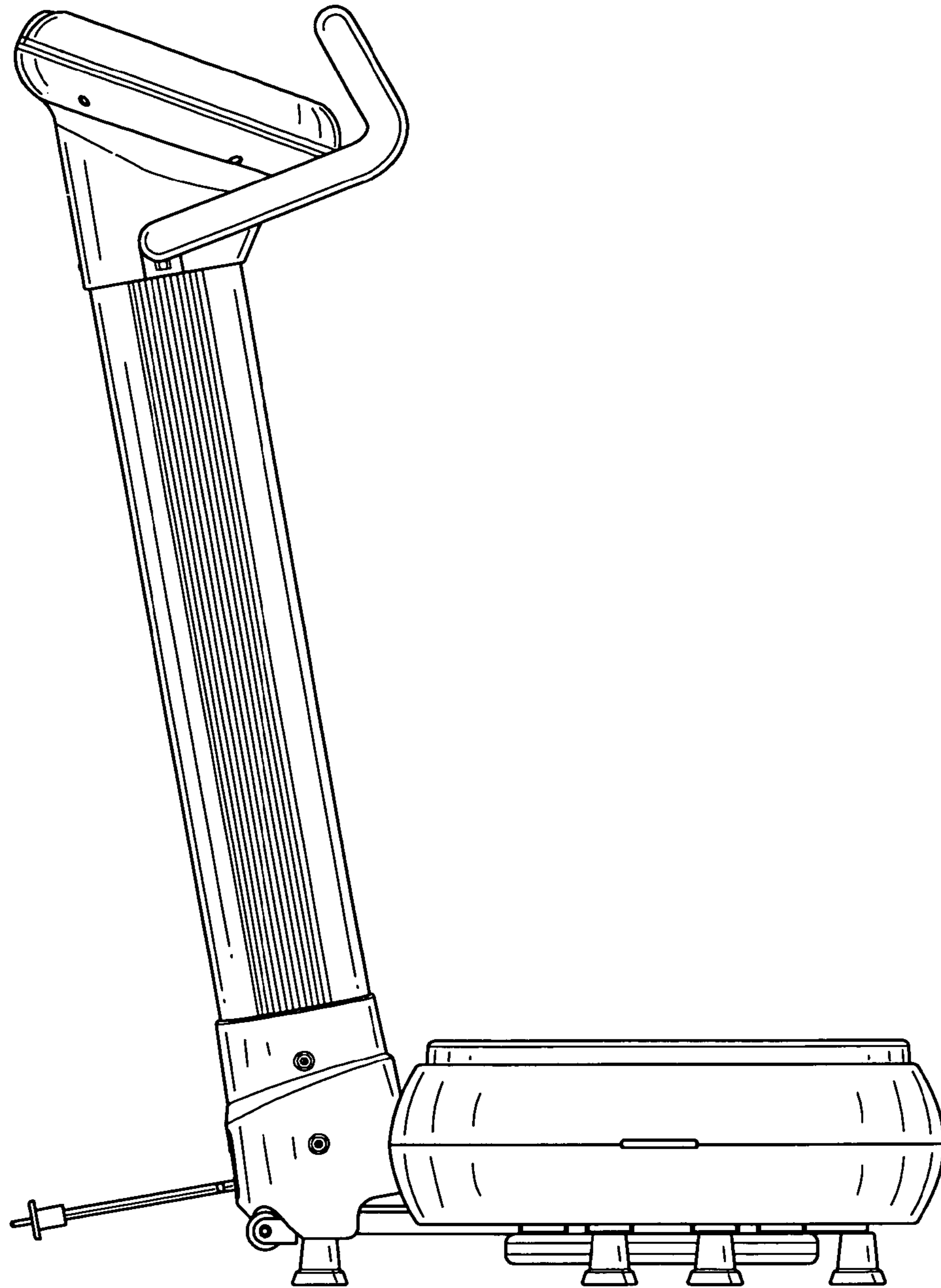

FIG.4

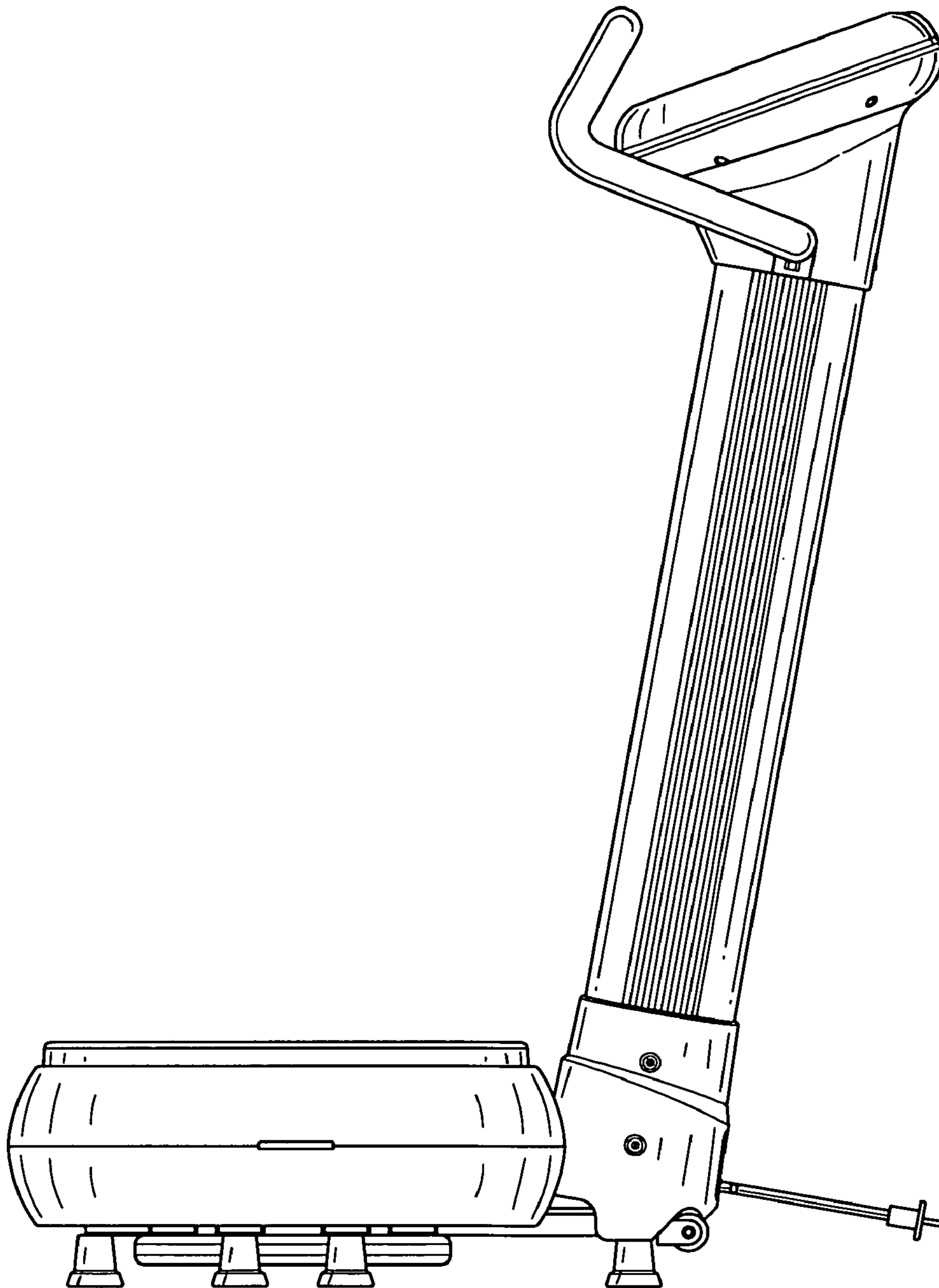

FIG.5

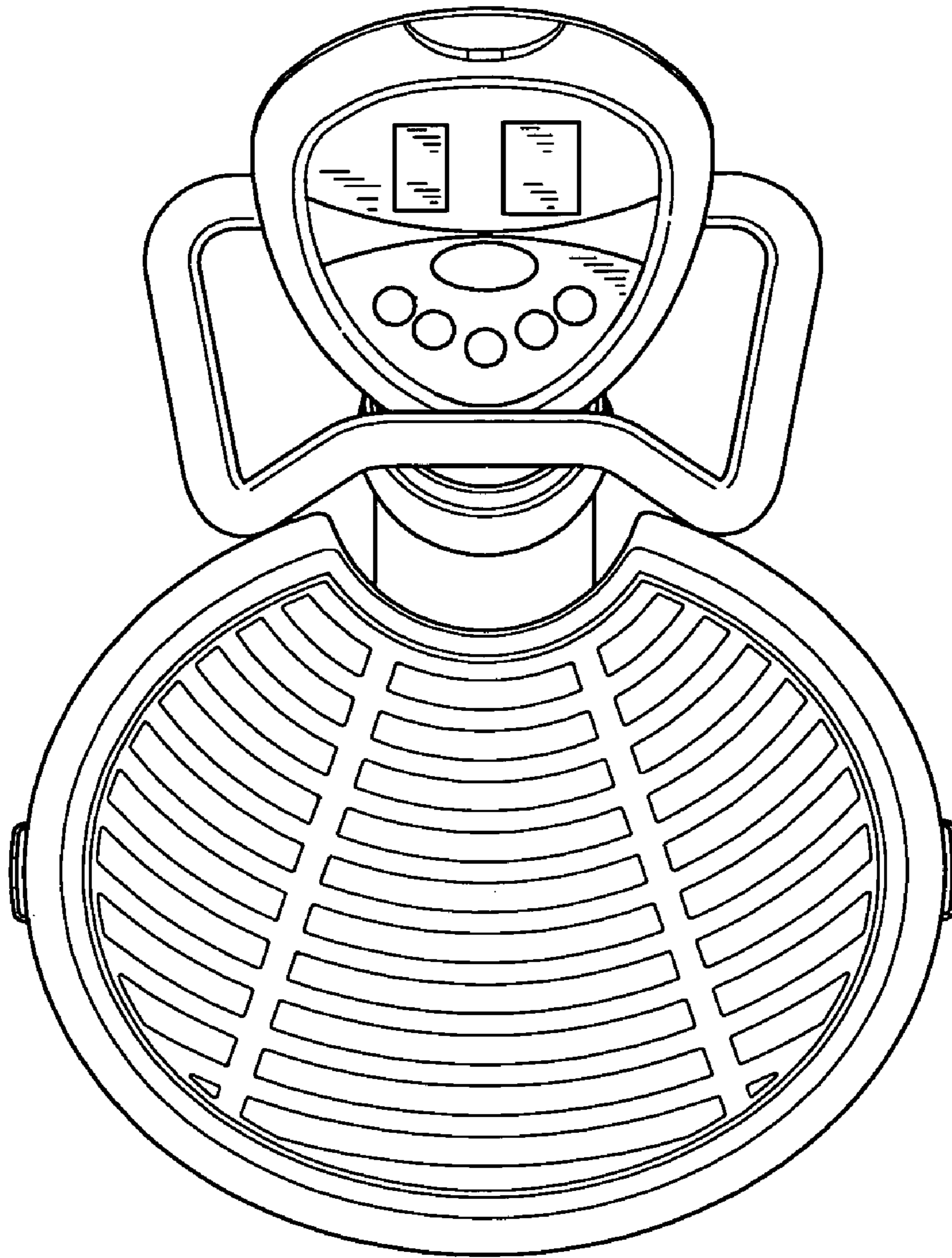

FIG.6

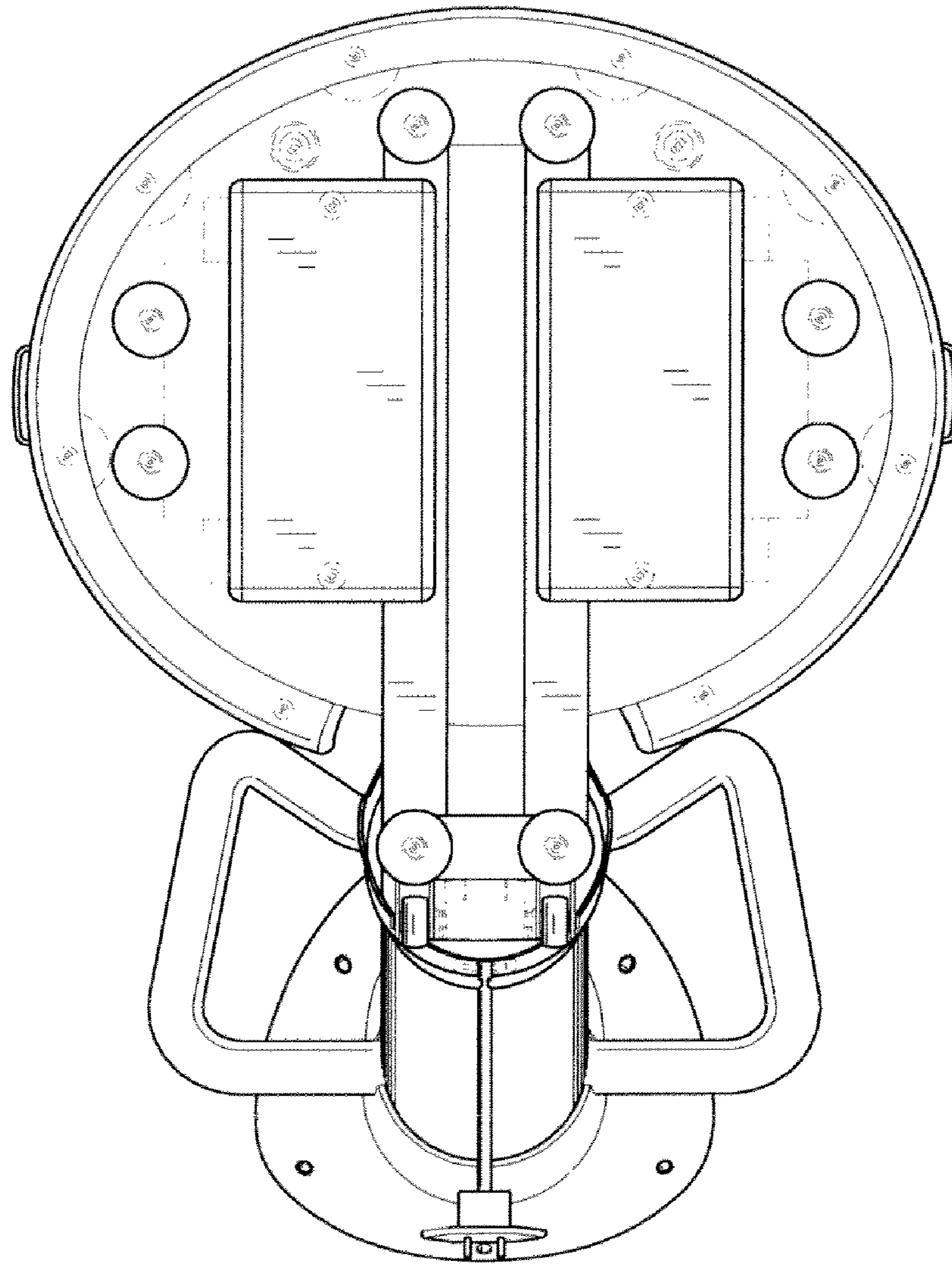

FIG. 7