



US00D635190S

(12) **United States Design Patent**  
**Merrill et al.**

(10) **Patent No.:** **US D635,190 S**  
(45) **Date of Patent:** **\*\* Mar. 29, 2011**

(54) **INTERACTIVE PLAY AND LEARNING SYSTEM**

(75) Inventors: **David Jeffrey Merrill**, San Francisco, CA (US); **Jeevan James Kalanithi**, San Francisco, CA (US); **Brent Paul Fitzgerald**, San Francisco, CA (US)

(73) Assignee: **SIFTEO, Inc.**, San Francisco, CA (US)

(\*\*) Term: **14 Years**

(21) Appl. No.: **29/376,968**

(22) Filed: **Oct. 14, 2010**

(51) **LOC (9) Cl.** ..... **19-07**

(52) **U.S. Cl.** ..... **D19/60**

(58) **Field of Classification Search** ..... D21/331-332, D21/346, 595; D19/59-64; 434/112, 128, 434/156, 157, 159, 169, 309, 322; D14/158, D14/334, 339, 341-346, 390, 395

See application file for complete search history.

(56) **References Cited**

**U.S. PATENT DOCUMENTS**

D329,062	S	*	9/1992	Chin	.....	D21/331
5,263,865	A	*	11/1993	Zipf	.....	434/309
5,865,625	A	*	2/1999	Baskerville	.....	434/157
D447,179	S	*	8/2001	Lusala	.....	D19/60
D537,119	S	*	2/2007	Traub	.....	D19/59
D557,338	S	*	12/2007	Delman et al.	.....	D19/60
D583,416	S	*	12/2008	Cisneros	.....	D19/59
D601,628	S	*	10/2009	Escobar	.....	D19/59
D619,652	S	*	7/2010	Voss	.....	D19/60
2008/0113321	A1	*	5/2008	Kelley et al.	.....	434/169

\* cited by examiner

*Primary Examiner* — T. Chase Nelson  
*Assistant Examiner* — Mark Cavanna  
(74) *Attorney, Agent, or Firm* — Gregory & Martensen LLP

(57) **CLAIM**

The ornamental design for an interactive play and learning system, as shown and described.

**DESCRIPTION**

FIG. 1 is a top rear perspective view of an interactive play and learning system showing our new design;  
FIG. 2 is a top rear perspective view of the clear cover;  
FIG. 3 is a bottom front perspective view of the clear cover;  
FIG. 4 is a top view of the clear cover;  
FIG. 5 is a bottom view of the clear cover;  
FIG. 6 is a front view of the clear cover;  
FIG. 7 is a rear view of the clear cover;  
FIG. 8 are right and left side views of the clear cover;  
FIG. 9 is a top front perspective view of the base and siftables with one siftable removed for clarity of illustration;  
FIG. 10 is a top rear perspective view of the base and siftables;  
FIG. 11 is a top rear perspective view of the base;  
FIG. 12 is a top view of the base;  
FIG. 13 is a bottom view of the base;  
FIG. 14 is a front view of the base;  
FIG. 15 is a rear view of the base;  
FIG. 16 is a right side view of the base;  
FIG. 17 is a left side view of the base;  
FIG. 18 is a front perspective view of a siftable;  
FIG. 19 is a rear perspective view of a siftable;  
FIG. 20 is a front view of a siftable;  
FIG. 21 is a rear view of a siftable; and,  
FIG. 22 is a view of all sides of a siftable.  
The broken lines are included for the purpose of illustrating portions of the interactive play and learning system that form no part of the claimed design.

**1 Claim, 17 Drawing Sheets**

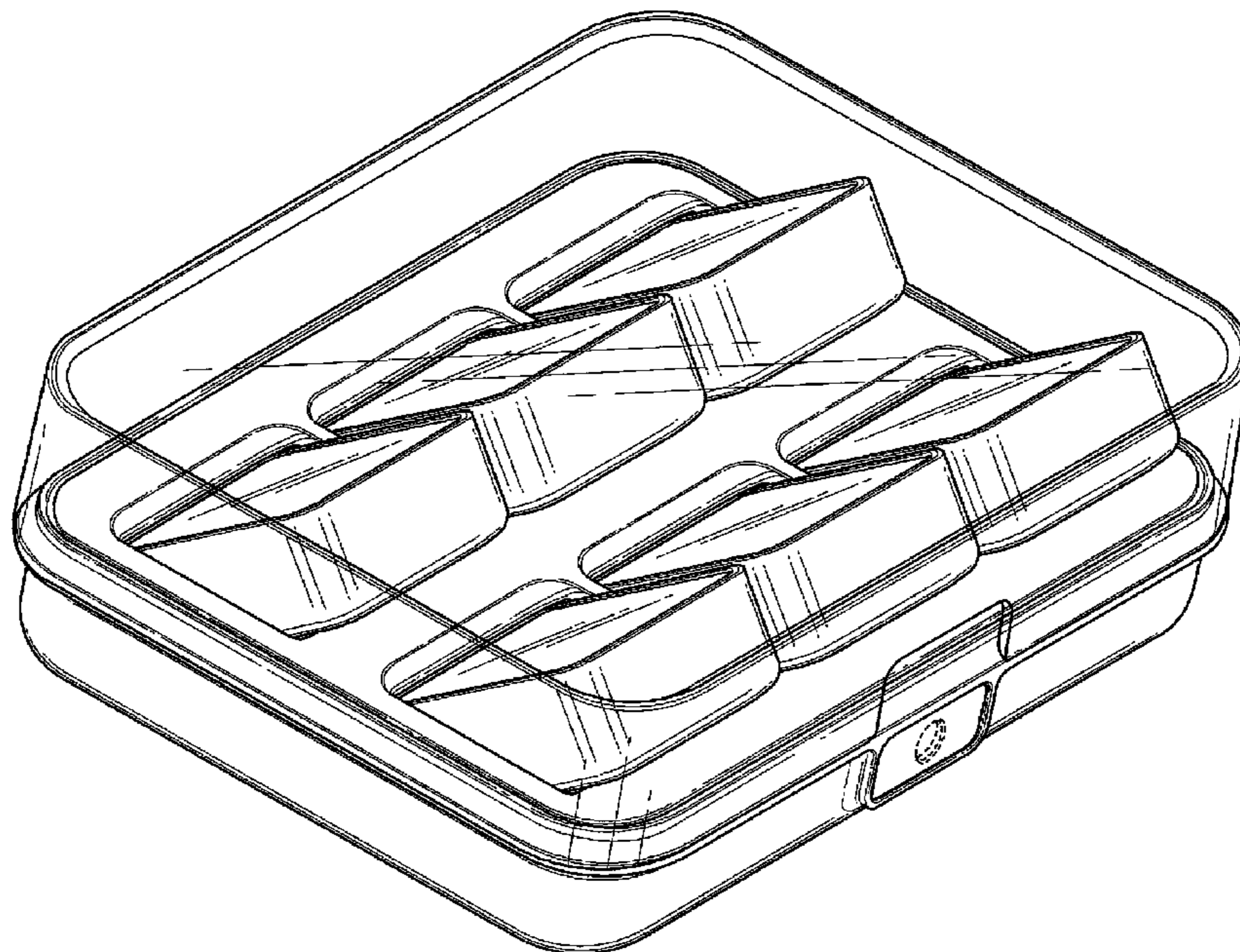

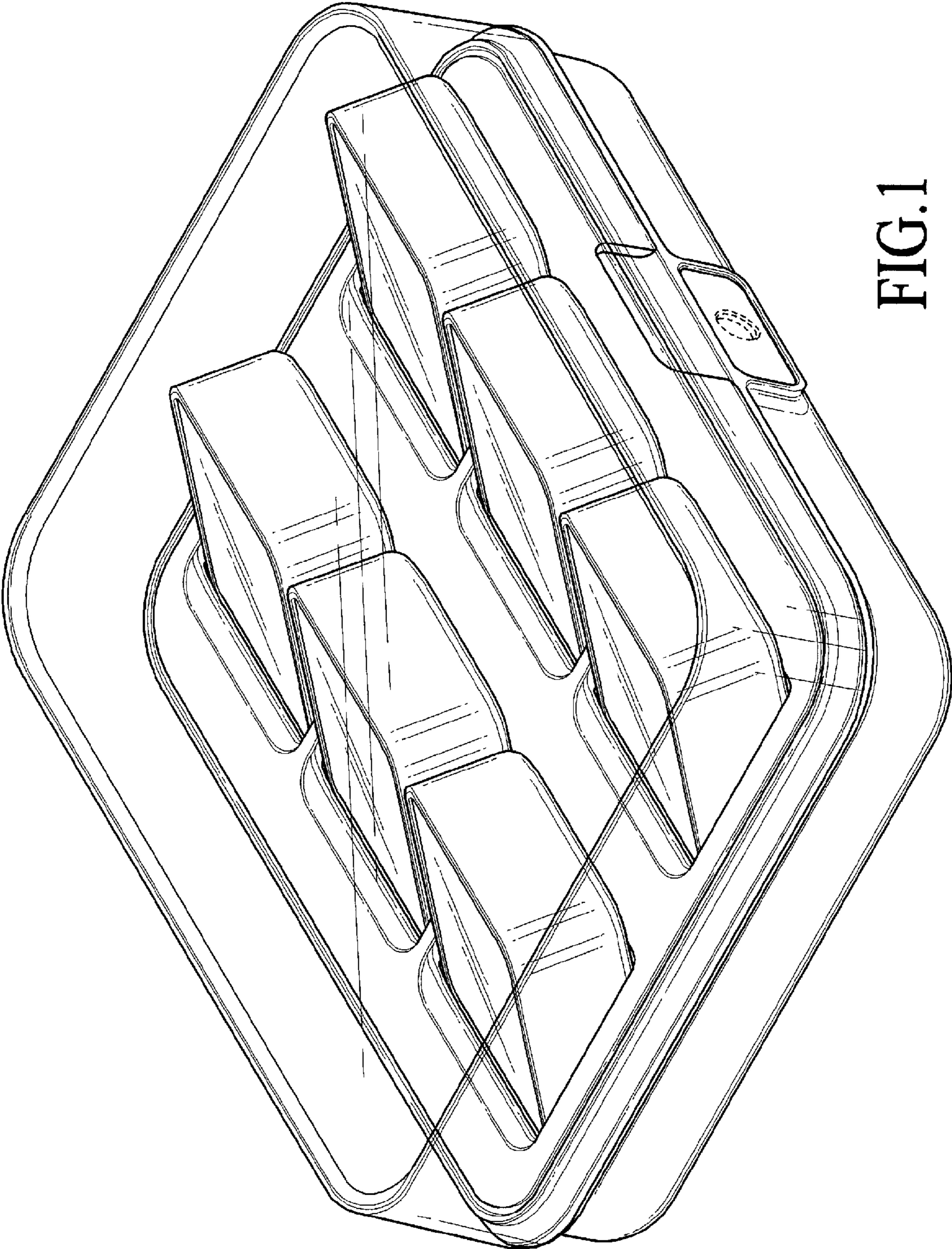

FIG.1

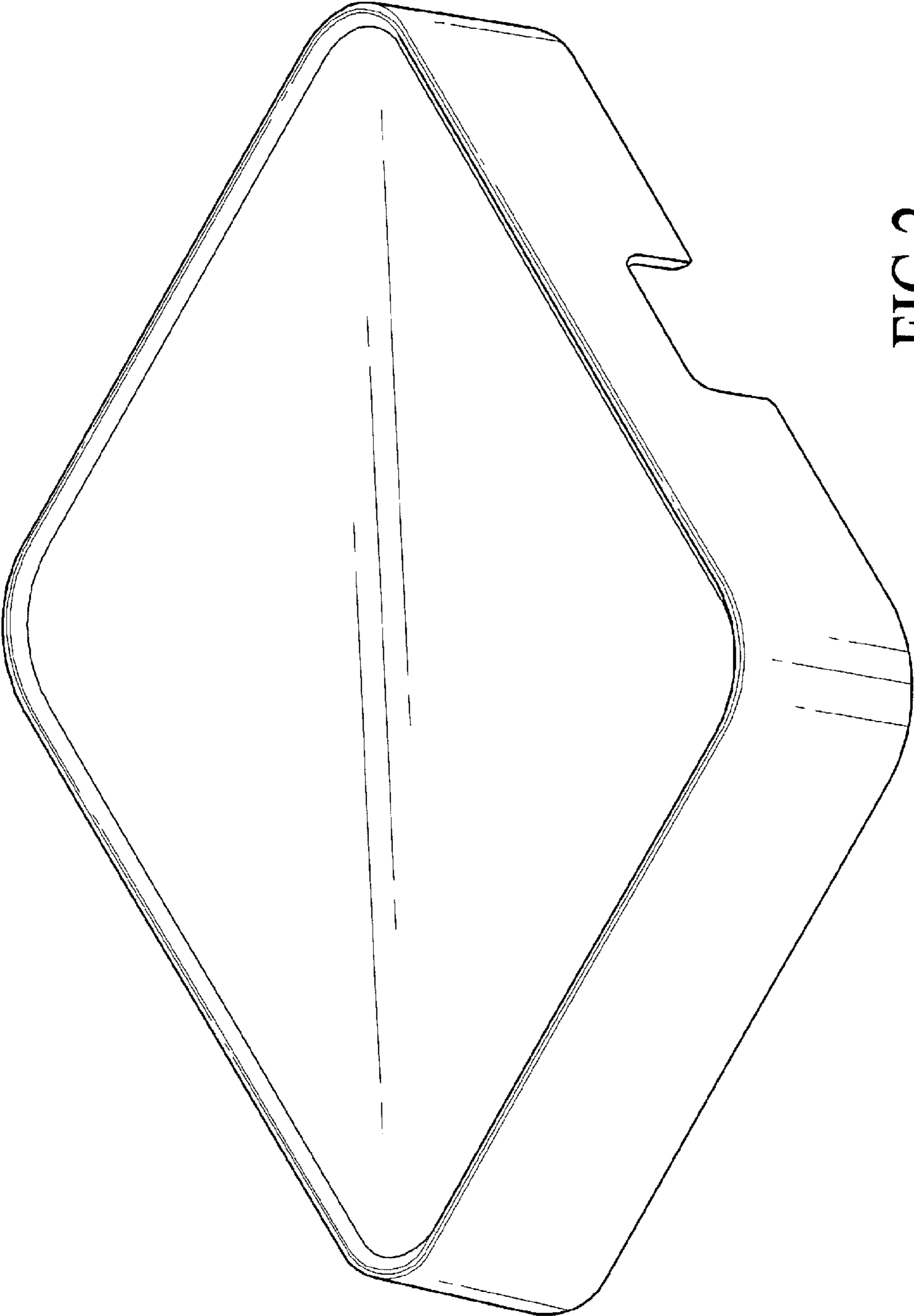

FIG.2

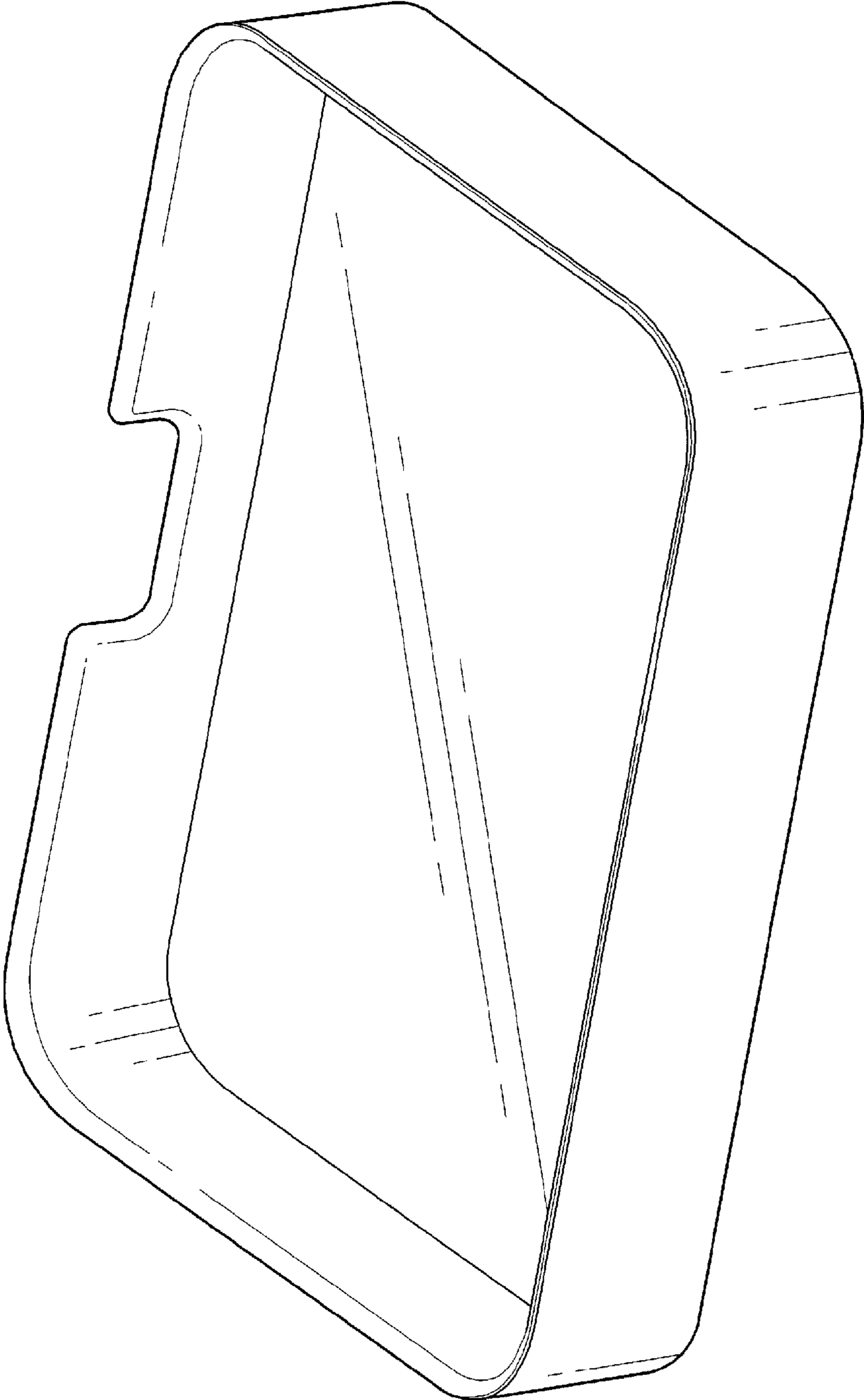

FIG.3

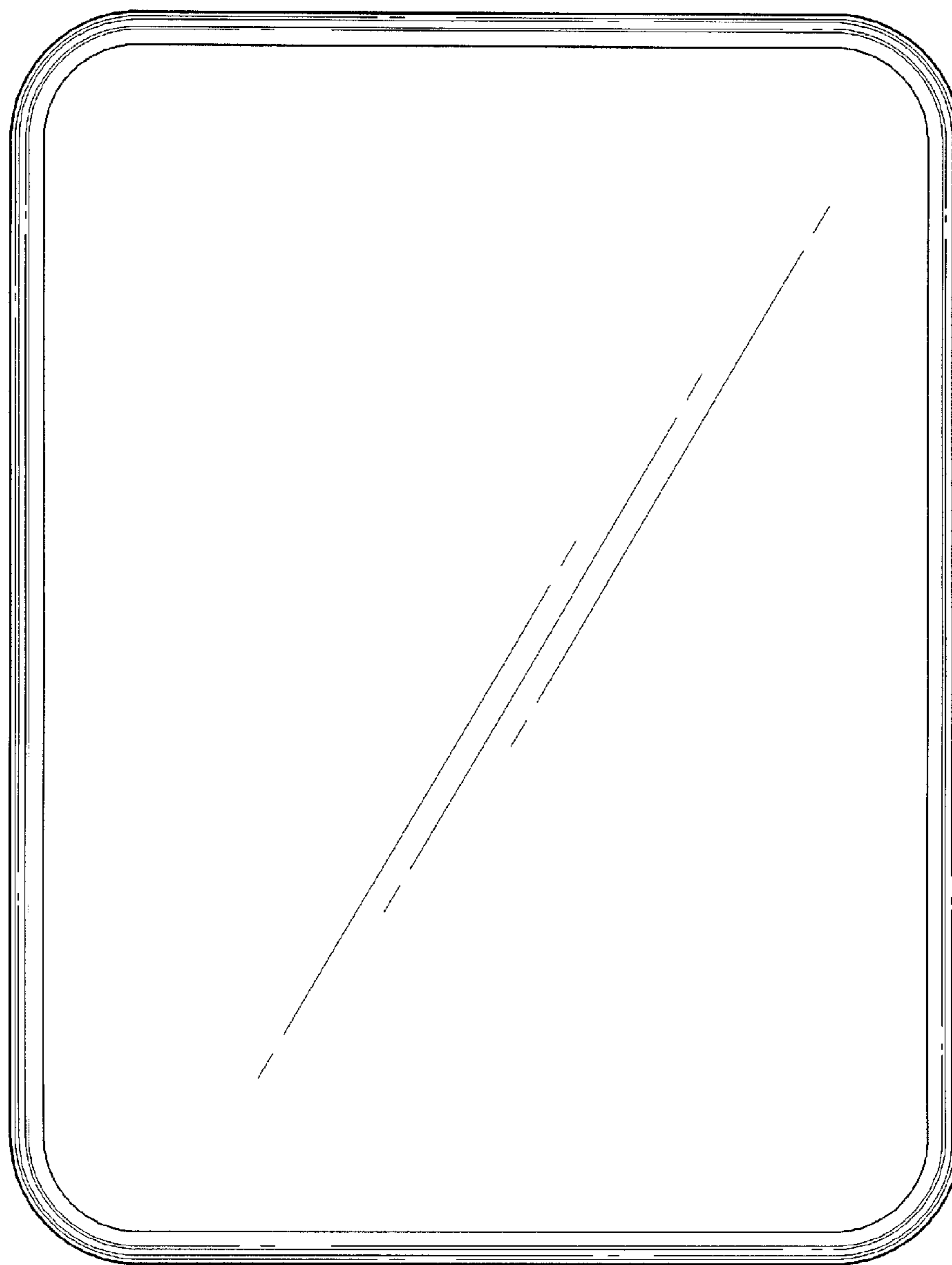

FIG.4

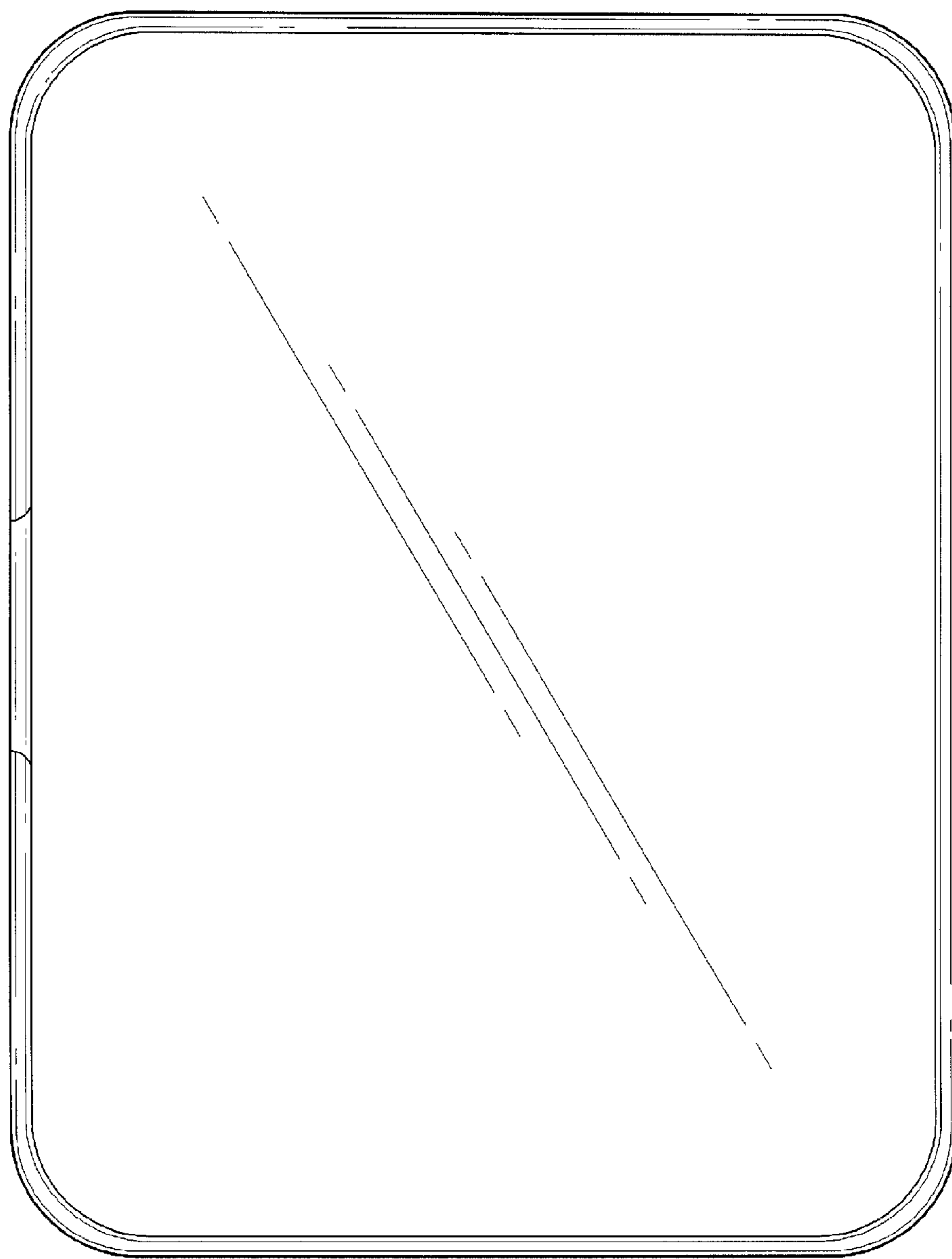

FIG. 5

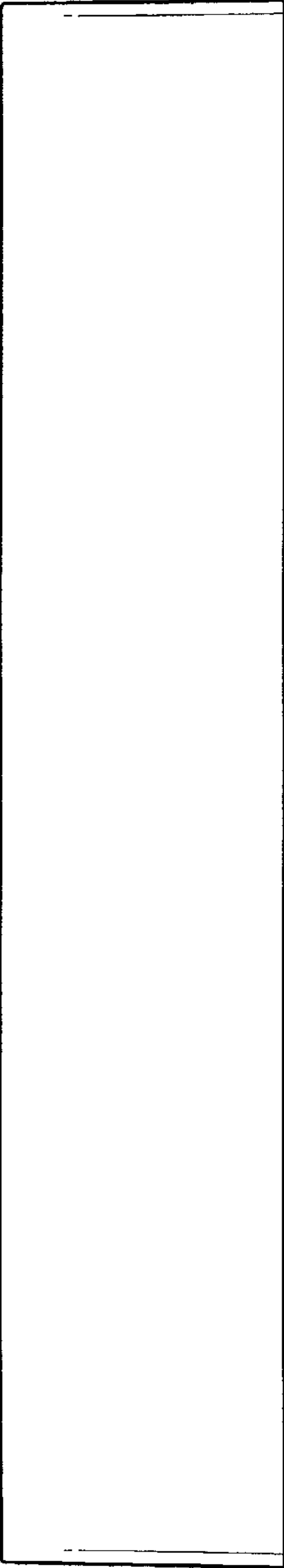

FIG. 6

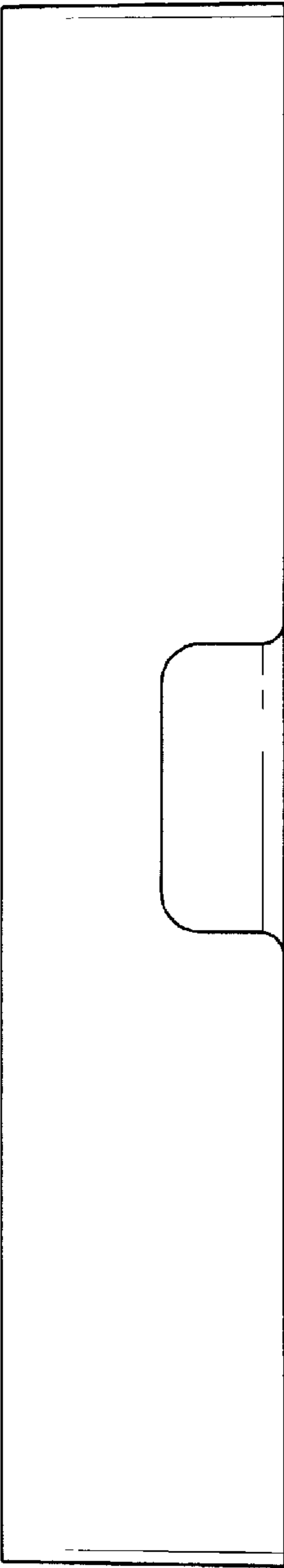

FIG. 7

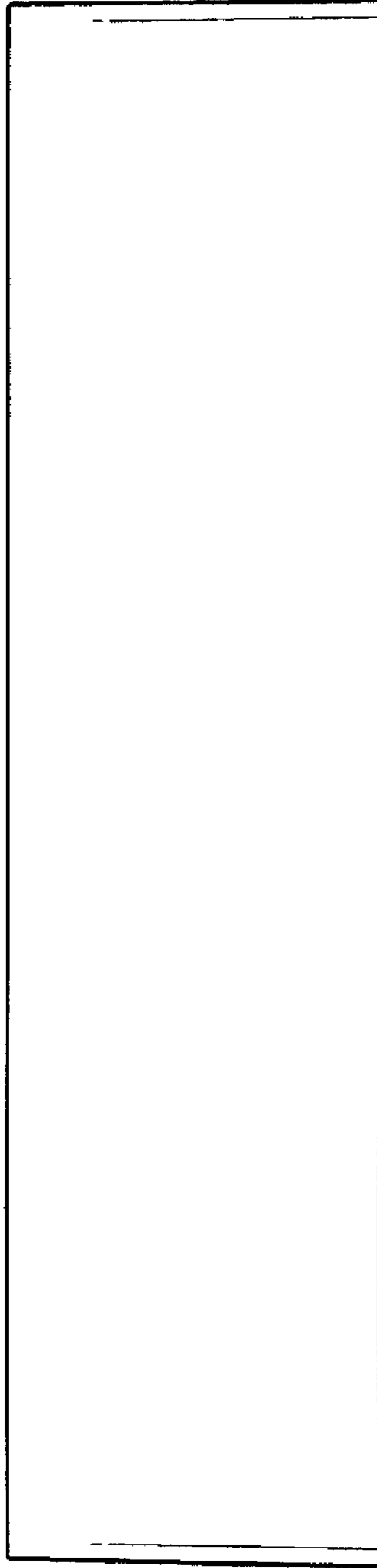

FIG. 8



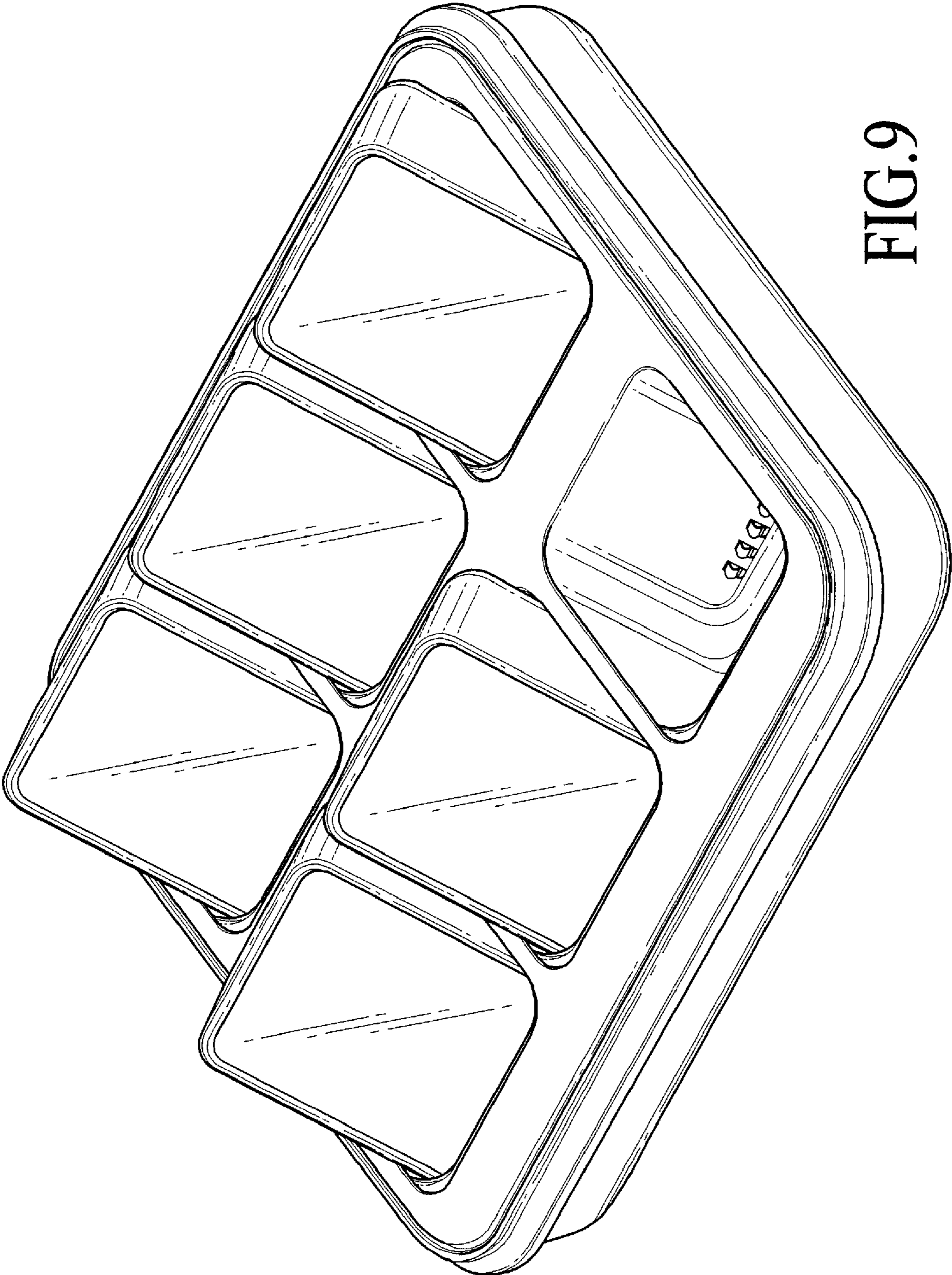

FIG. 9

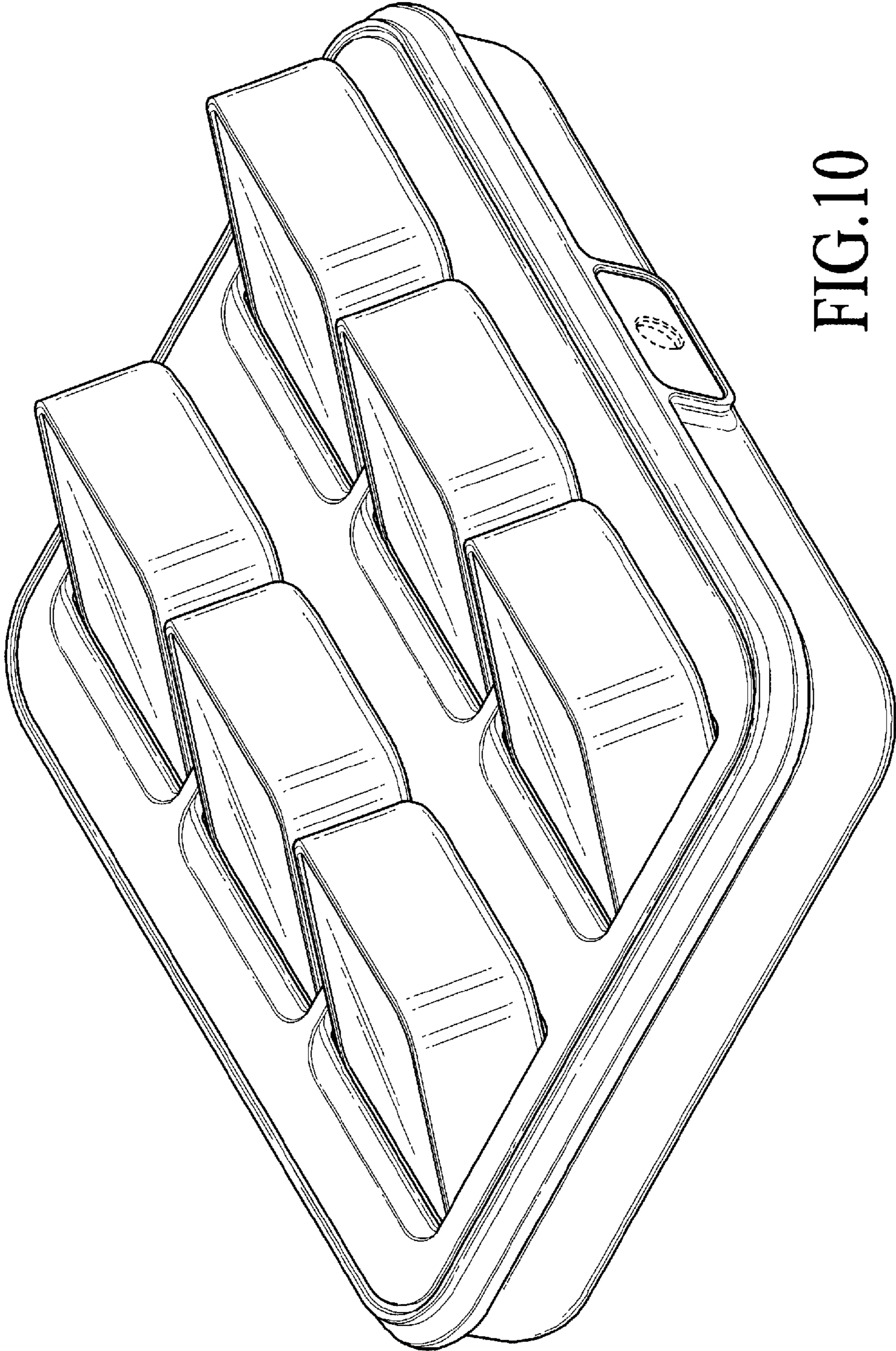

FIG. 10

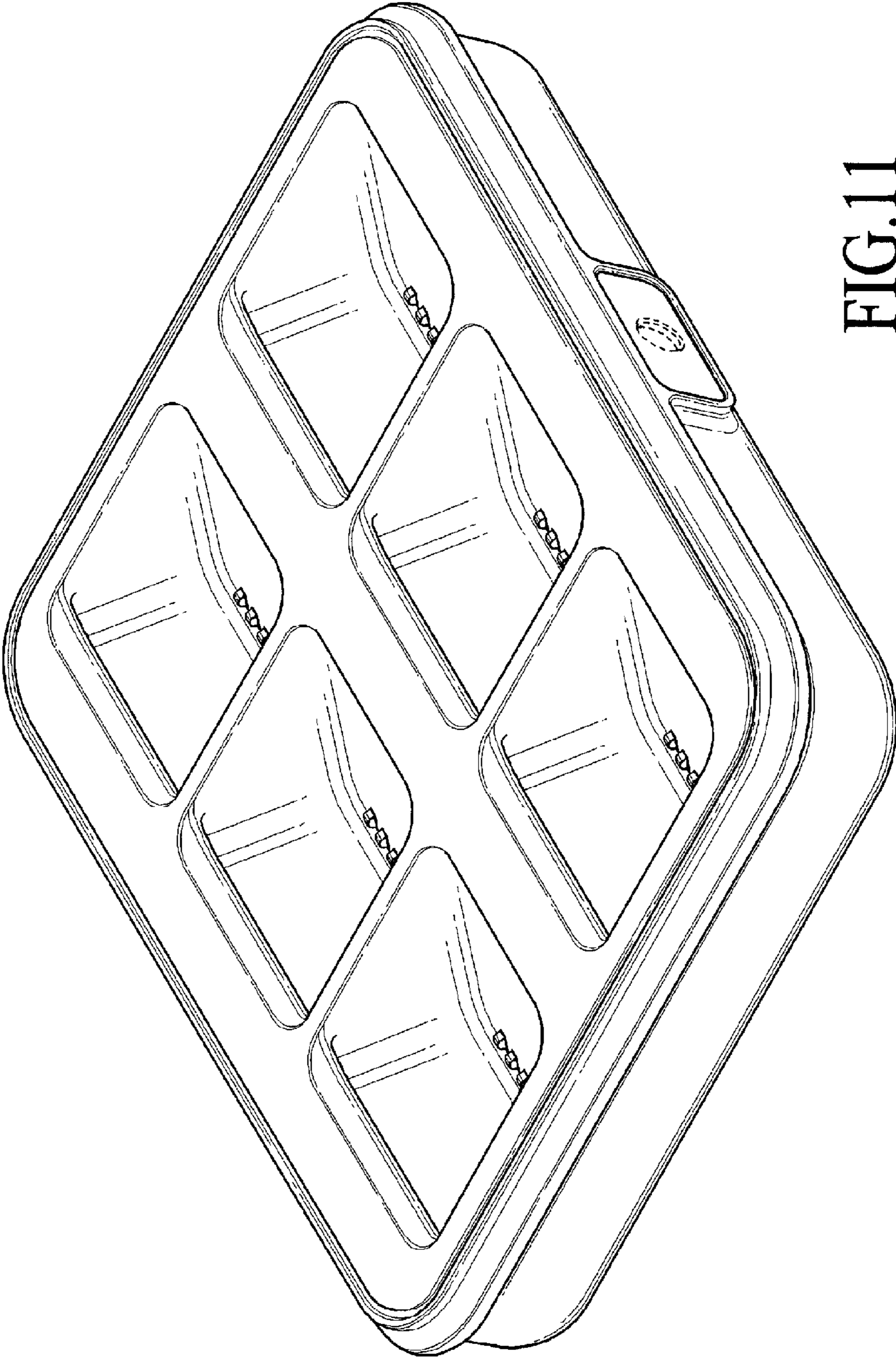

FIG.11

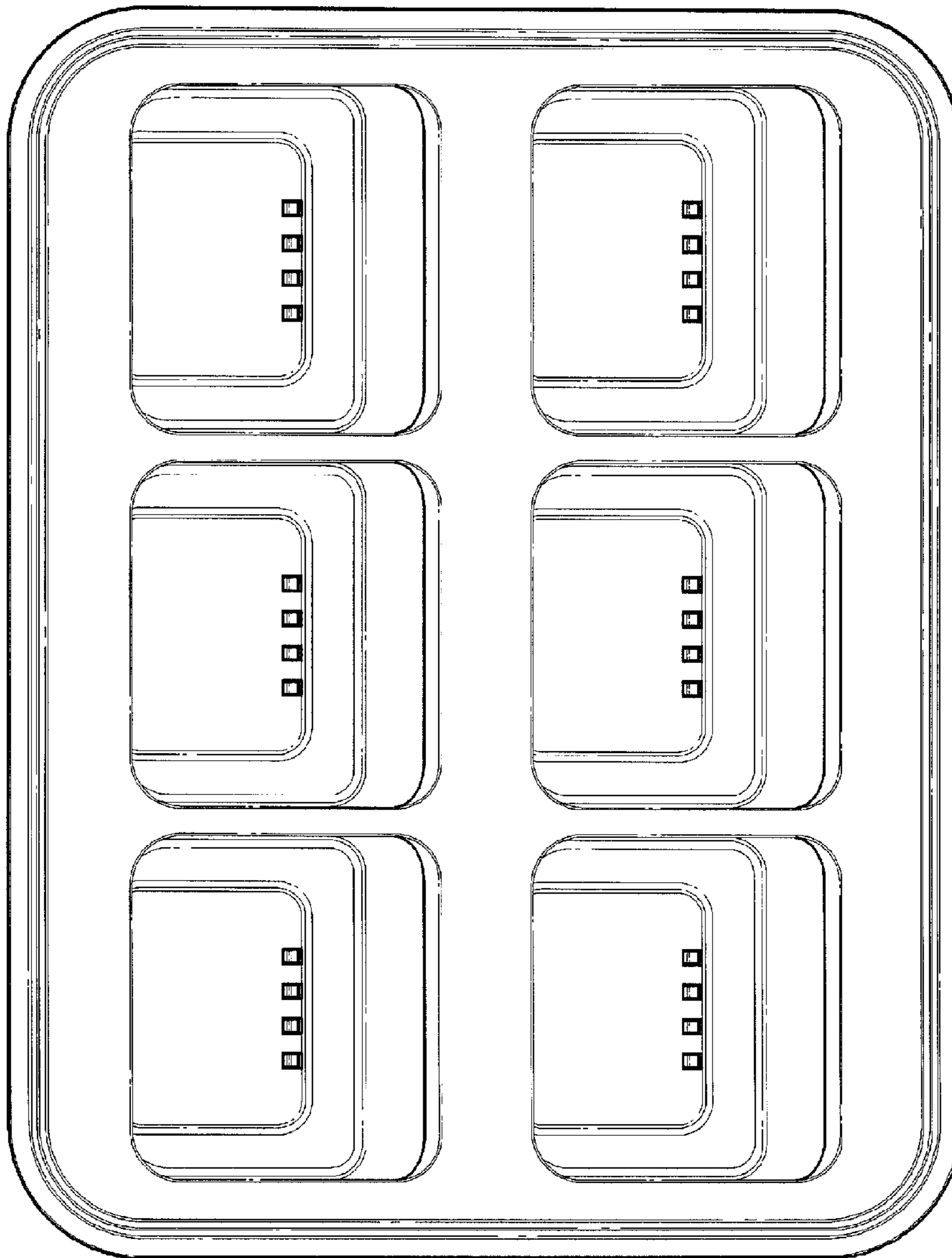

FIG.12

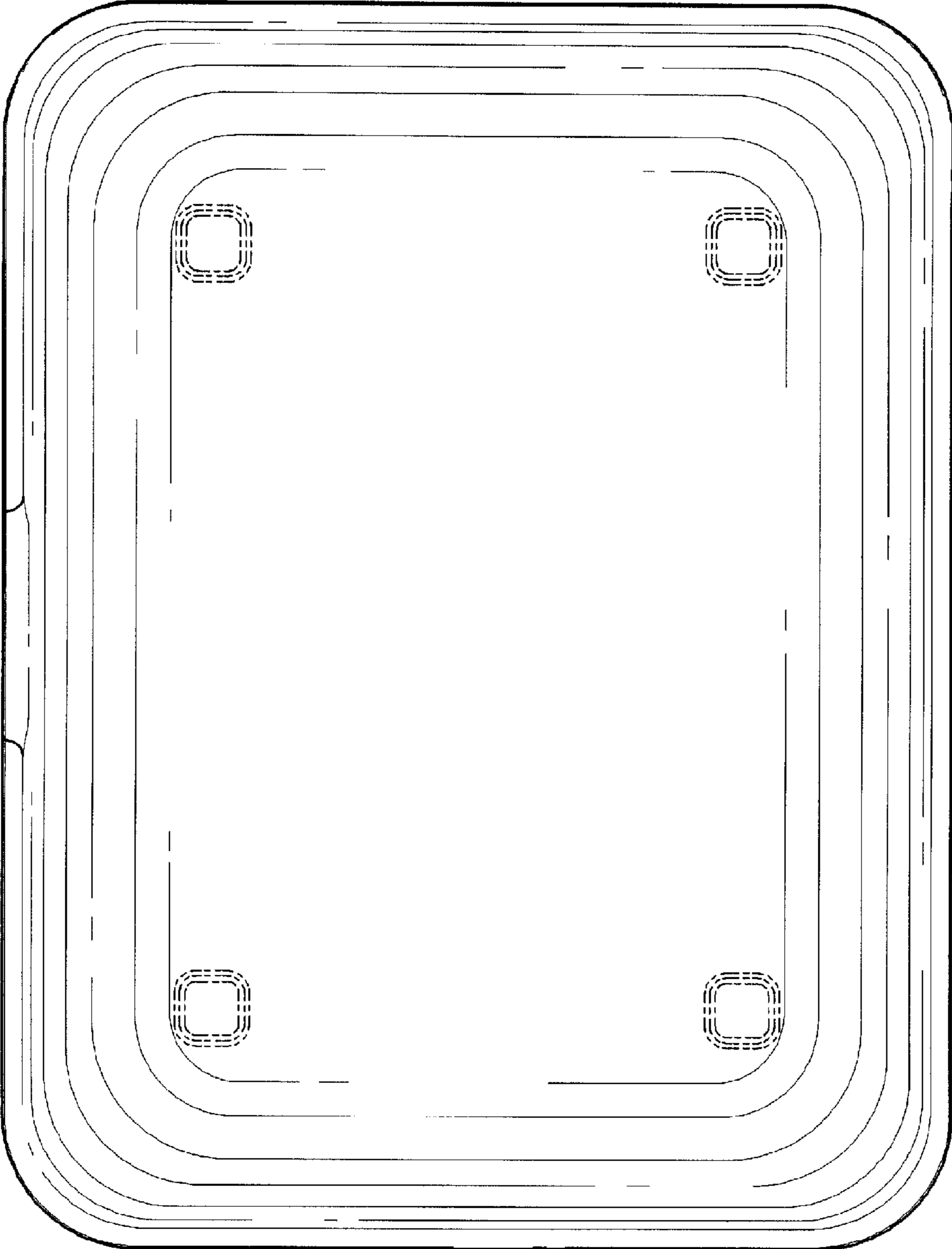

FIG.13

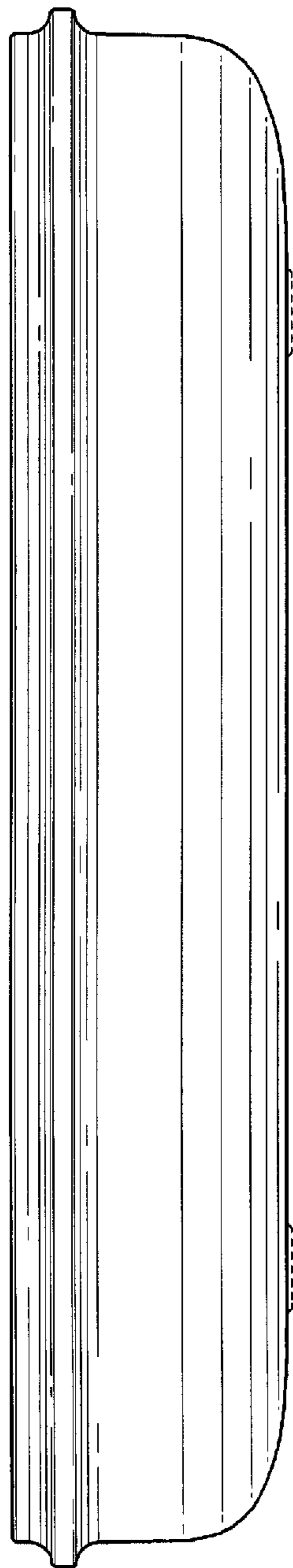

FIG.14

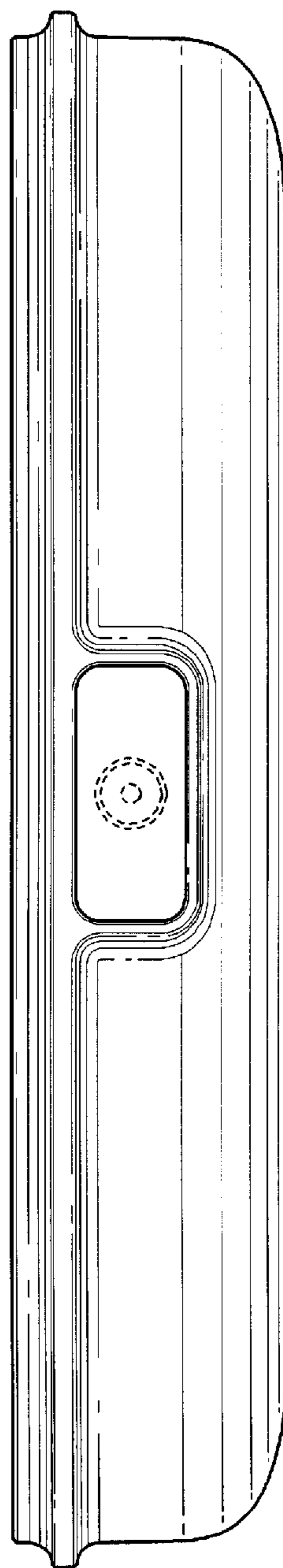

FIG.15

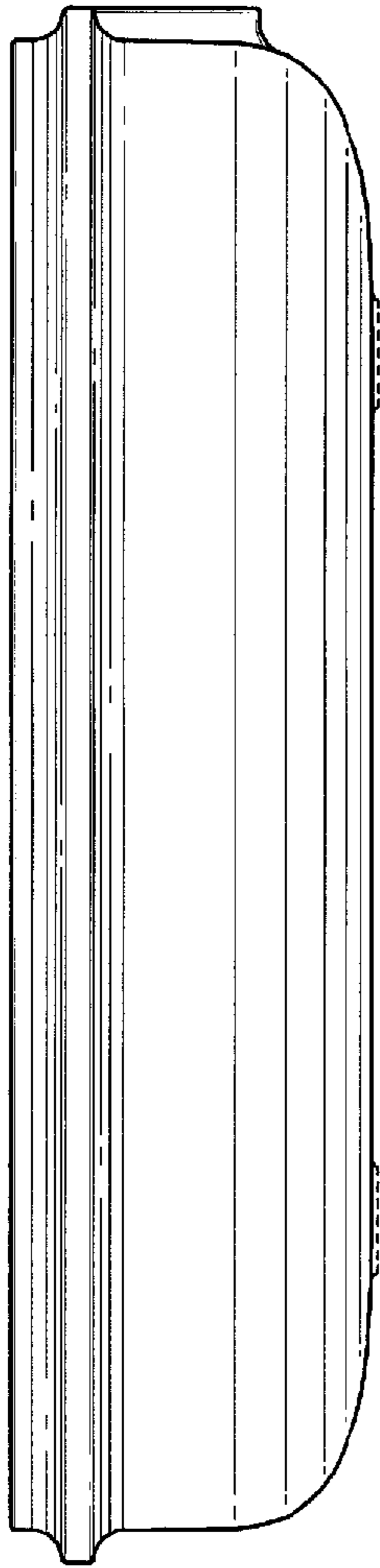

FIG. 16

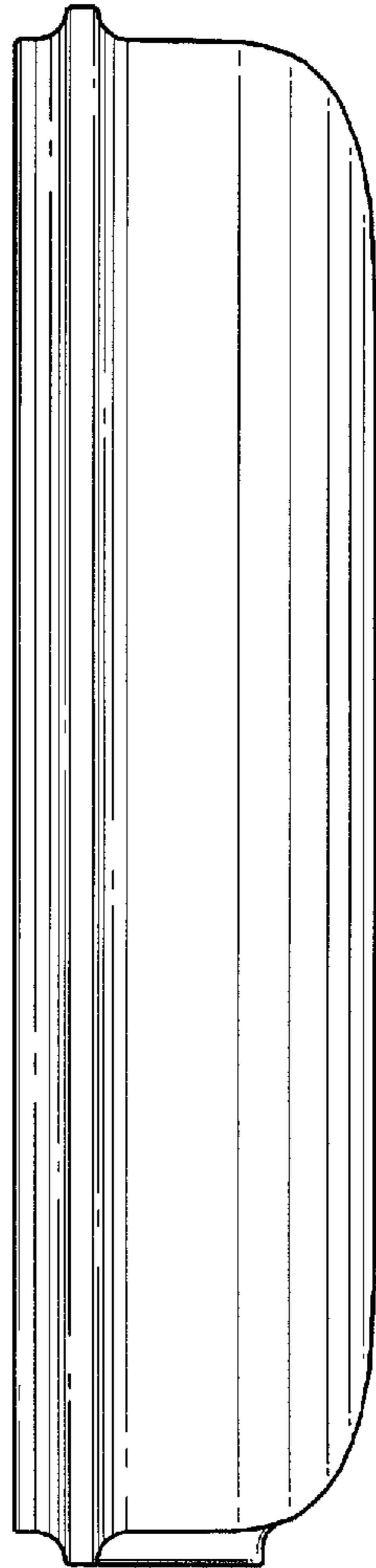

FIG. 17

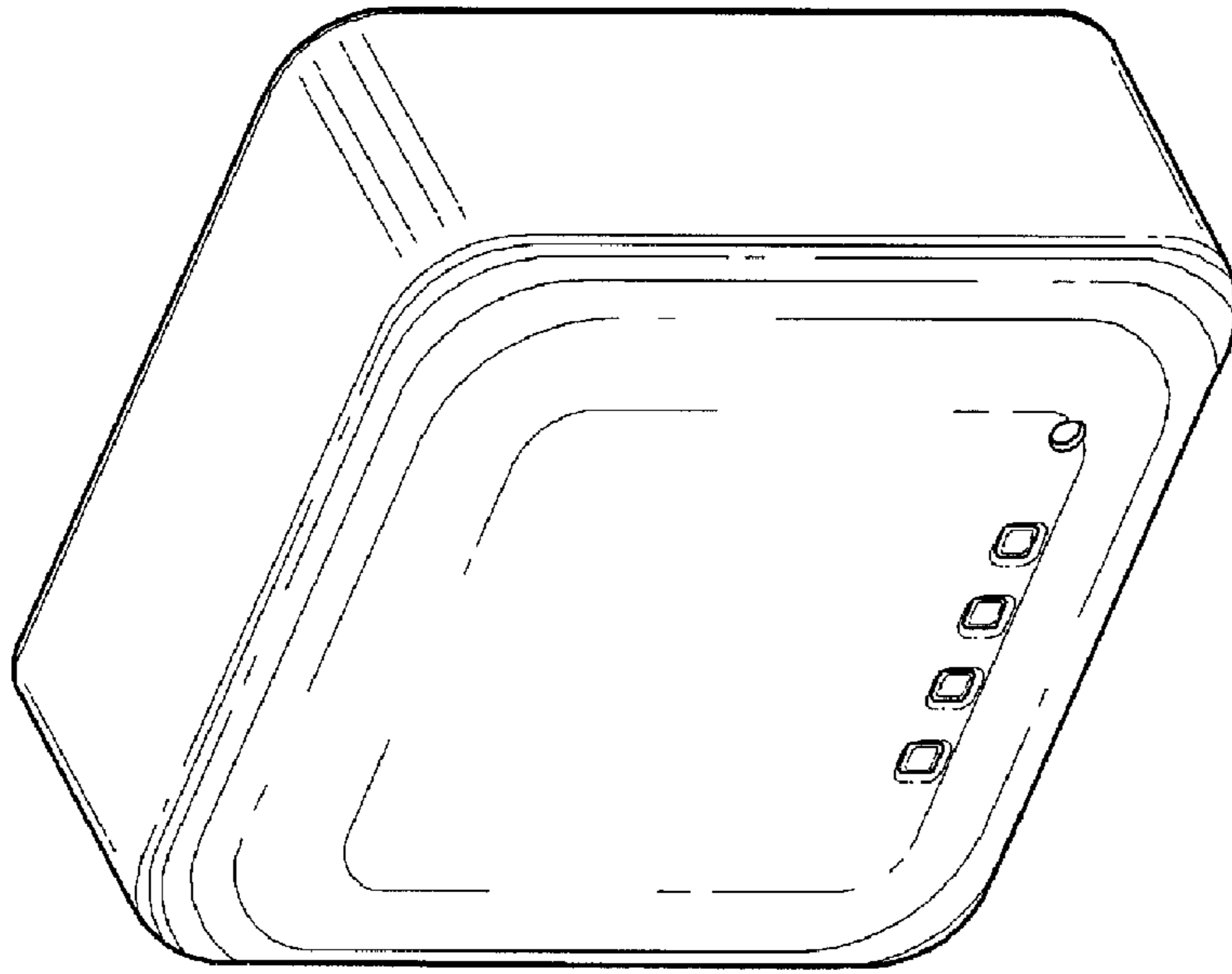

FIG. 19

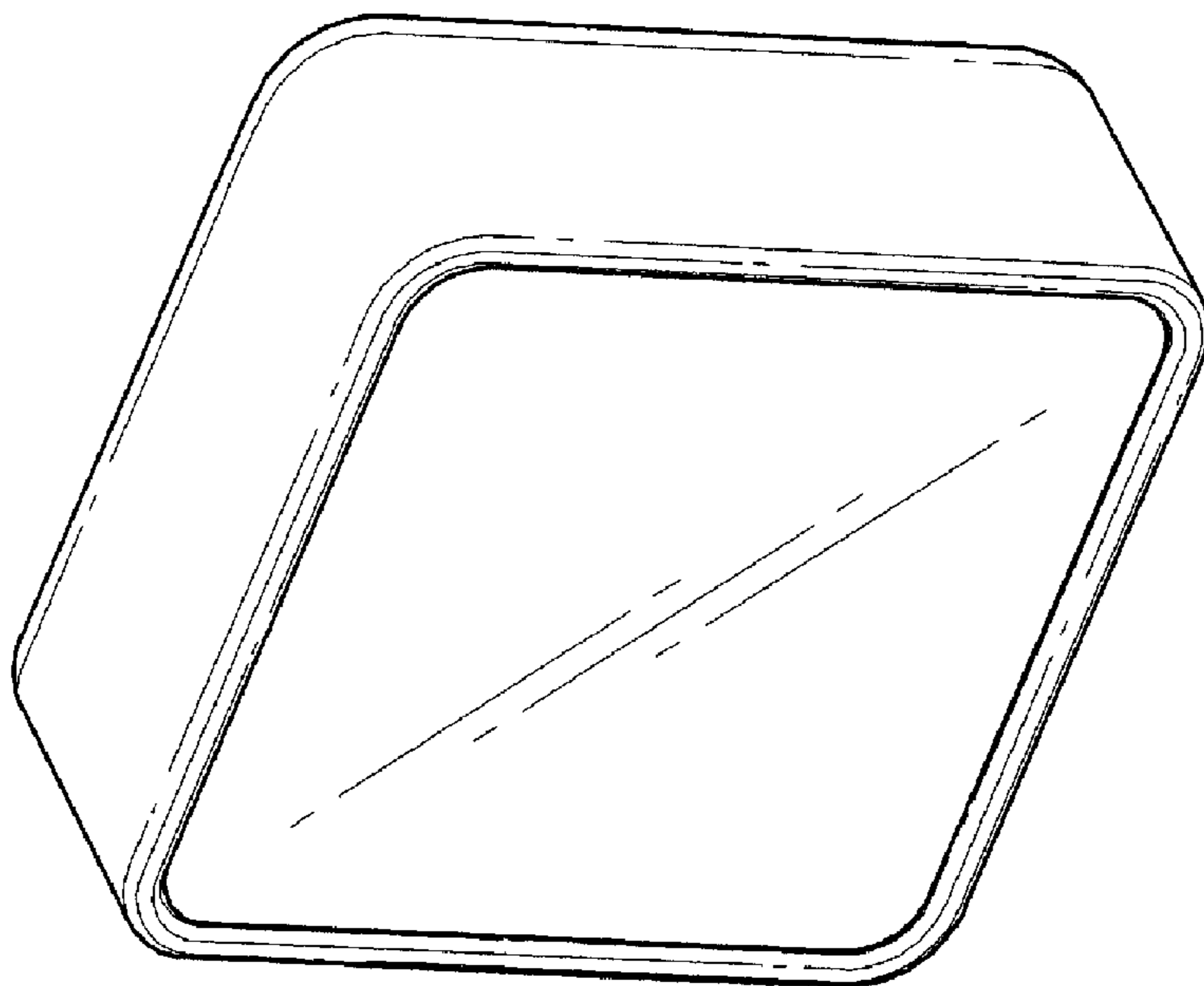

FIG. 18



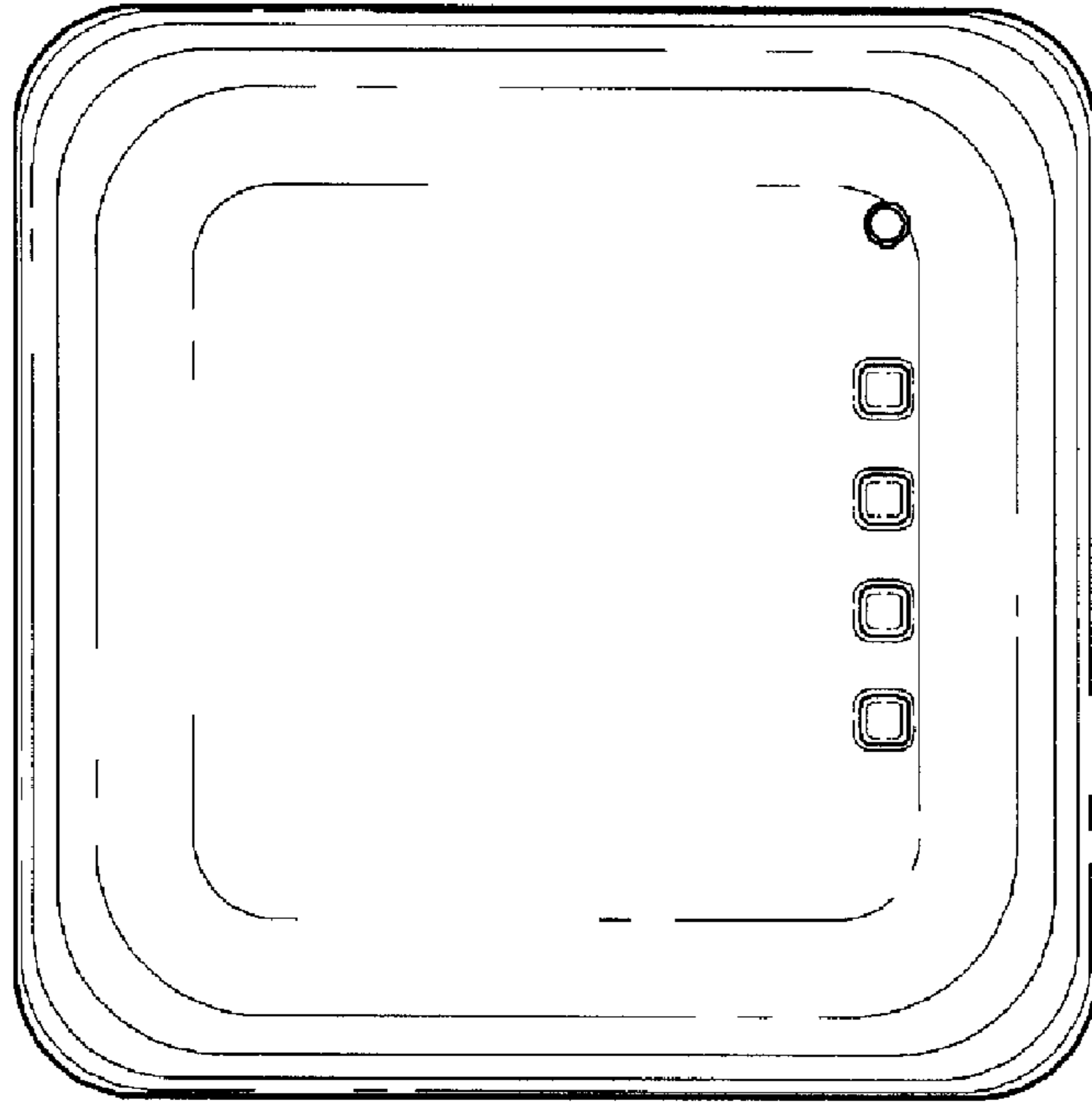

FIG. 21

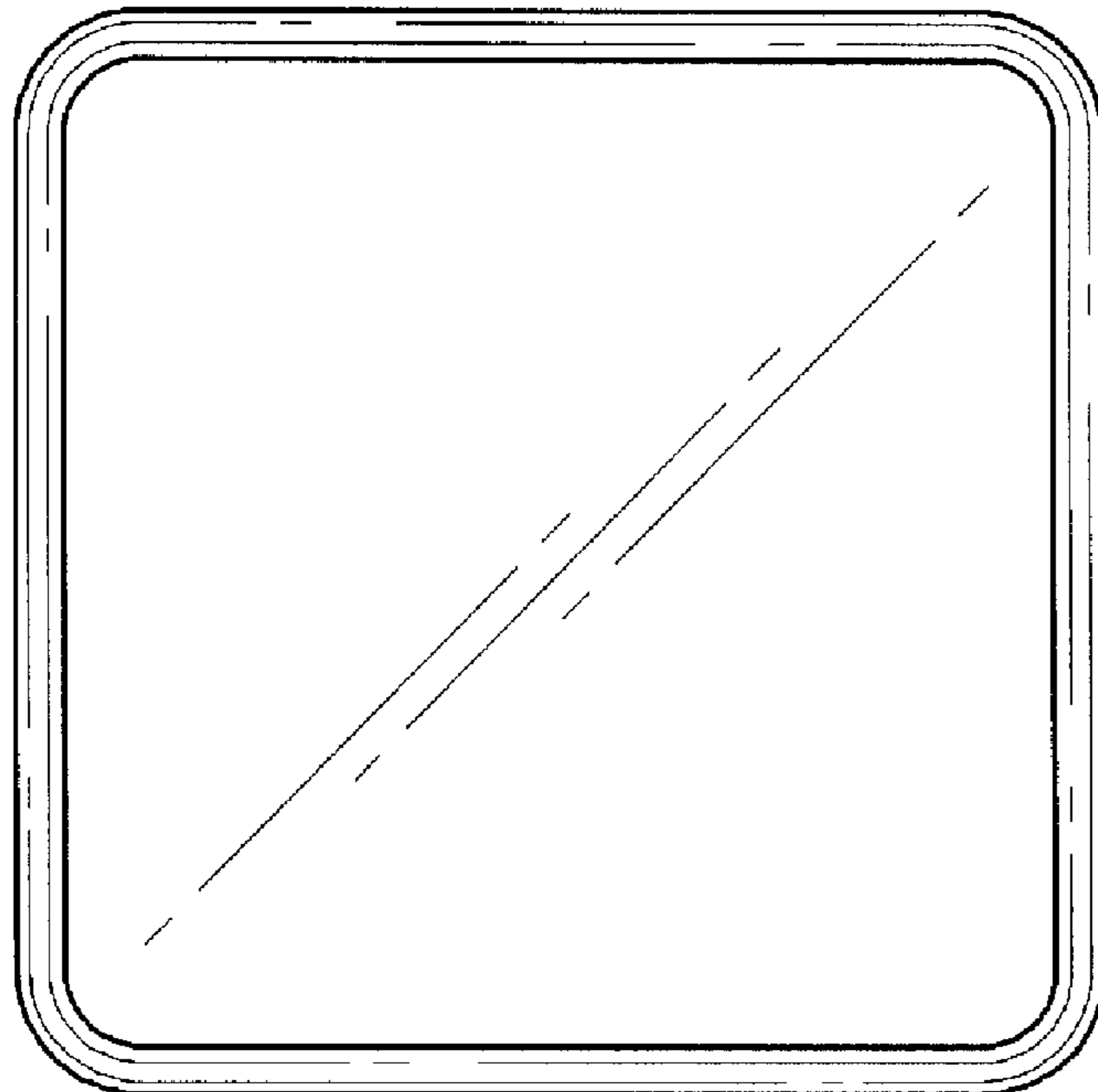

FIG. 20

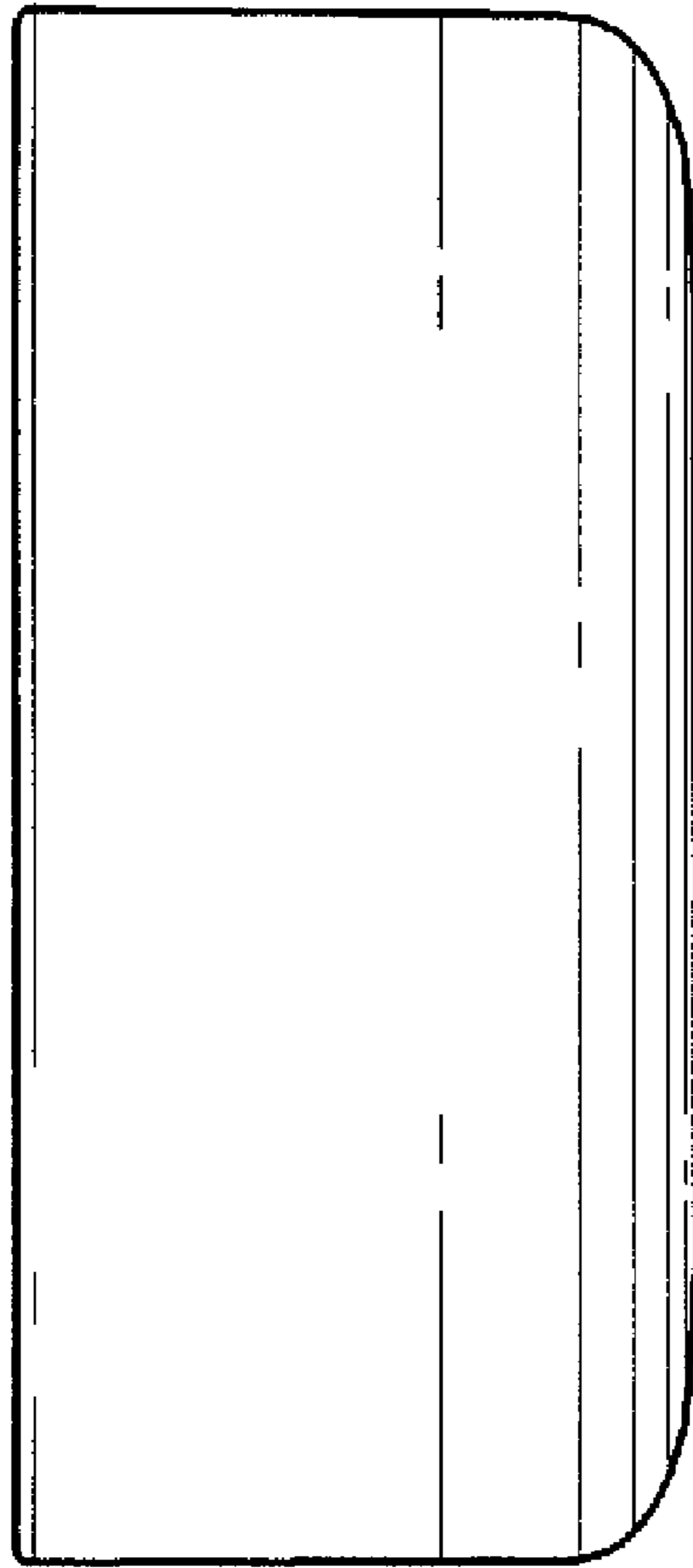

FIG. 22