



US00D635174S

(12) **United States Design Patent**  
**Stewart**

(10) **Patent No.:** **US D635,174 S**  
(45) **Date of Patent:** **\*\* Mar. 29, 2011**

(54) **KIT COMPRISING A COLLAR, COLLAR MOUNTED CAMERA, WIRELESS MONITOR AND REMOTE DEVICE**

7,424,867 B2 9/2008 Kates  
D605,213 S \* 12/2009 Liu et al. .... D16/208  
2007/0095304 A1 5/2007 Rosenberg et al.

\* cited by examiner

(76) Inventor: **Audrey Stewart**, Detroit, MI (US)

*Primary Examiner* — Adir Aronovich

(\*\*) Term: **14 Years**

(21) Appl. No.: **29/338,071**

(57) **CLAIM**

The ornamental design for the kit comprising a collar, collar mounted camera, wireless monitor and remote device, as shown and described.

(22) Filed: **Jun. 3, 2009**

(51) **LOC (9) Cl.** ..... **16-01**

(52) **U.S. Cl.** ..... **D16/208; D30/152**

(58) **Field of Classification Search** ..... D11/7;  
D16/200, 203, 208; D30/152; 119/856,  
119/858, 863, 864

**DESCRIPTION**

See application file for complete search history.

FIG. 1 is a front elevational view of the kit comprising a collar, collar mounted camera, wireless monitor and remote device showing my new design. The words "Chocolate Dog Cam" shown in broken lines are environmental matter only and form no part of the claimed design.

FIG. 2 is a rear elevational view thereof.

FIG. 3 is a left side elevational view thereof.

FIG. 4 is a right side elevational view thereof.

FIG. 5 is a top plan view thereof; and,

FIG. 6 is a bottom plan view thereof.

The claimed design is directed to a combination of a collar, collar mounted camera, wireless monitor and remote device worn by a dog and utilized as a unit.

(56) **References Cited**

**U.S. PATENT DOCUMENTS**

D193,404	S	*	8/1962	Telford	.....	D11/7
D306,504	S	*	3/1990	Young	.....	D30/152
4,996,948	A	*	3/1991	Klein et al.	.....	119/864
5,588,398	A		12/1996	Allen et al.		
D379,252	S	*	5/1997	McIntosh	.....	D30/152
D409,803	S		5/1999	Yoka		
6,598,563	B2		7/2003	Kim et al.		
D481,176	S	*	10/2003	Kellner	.....	D16/208
6,720,879	B2		4/2004	Edwards		

**1 Claim, 4 Drawing Sheets**

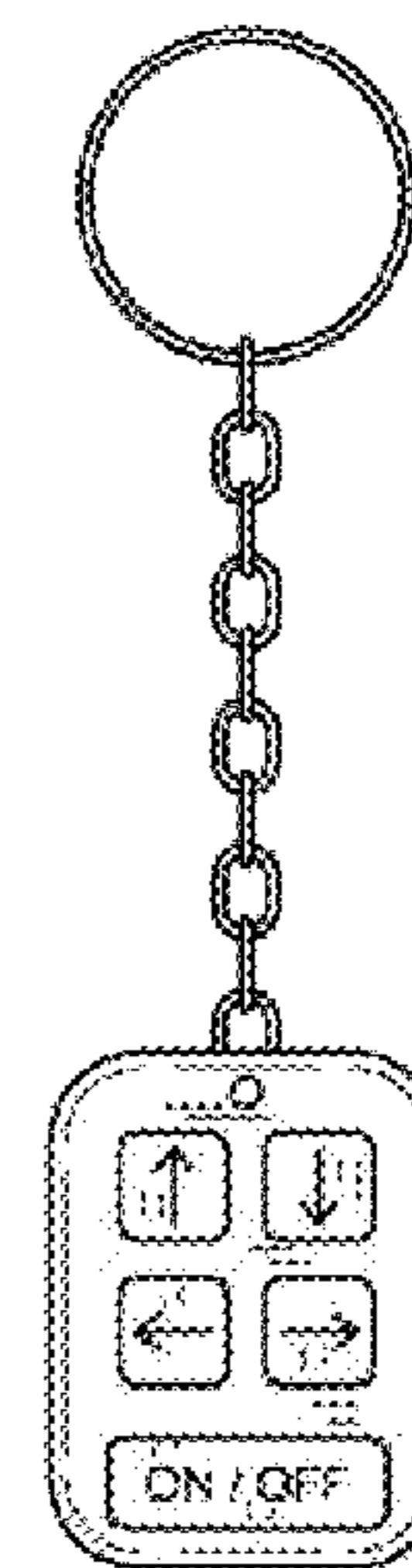
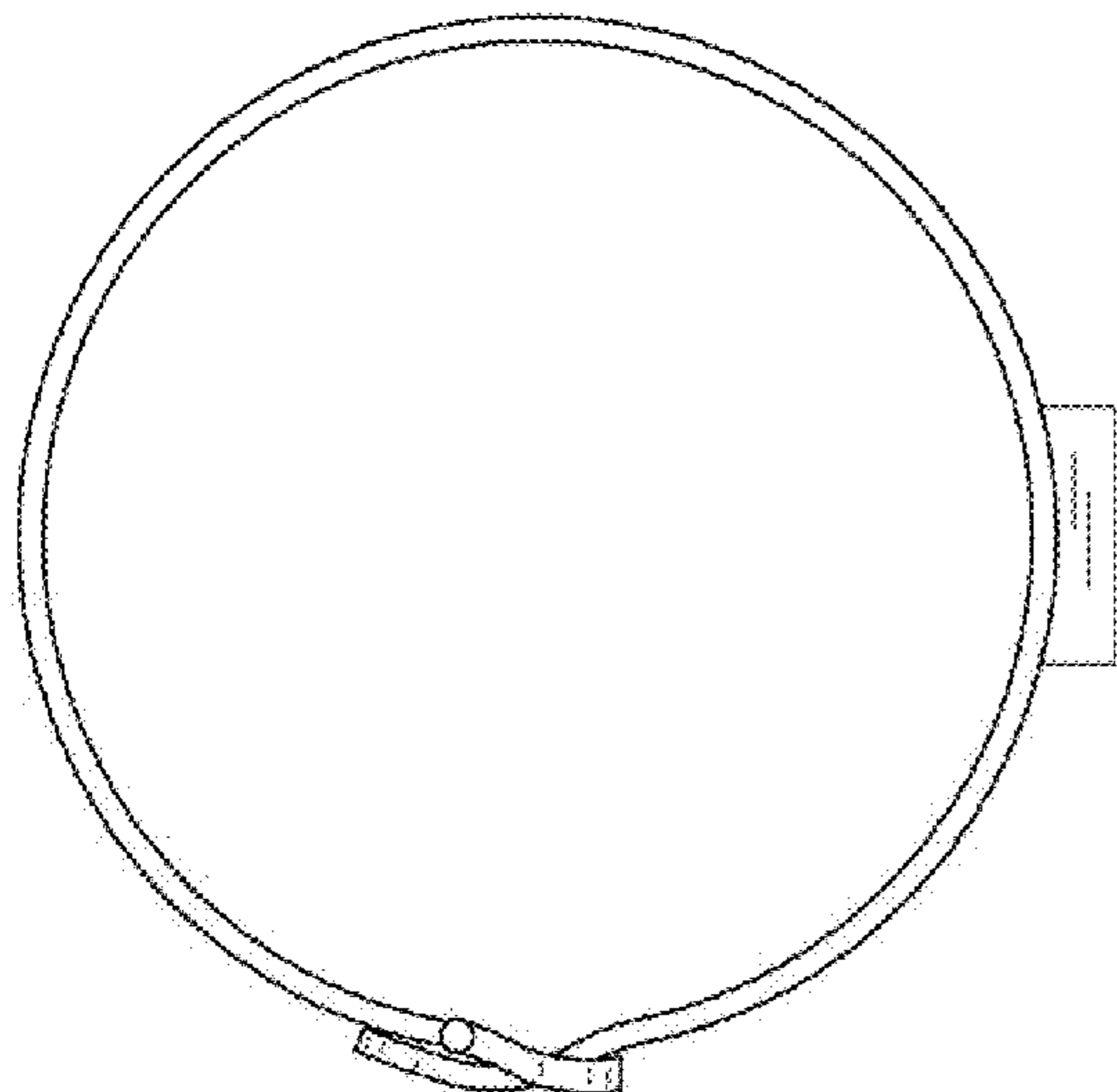

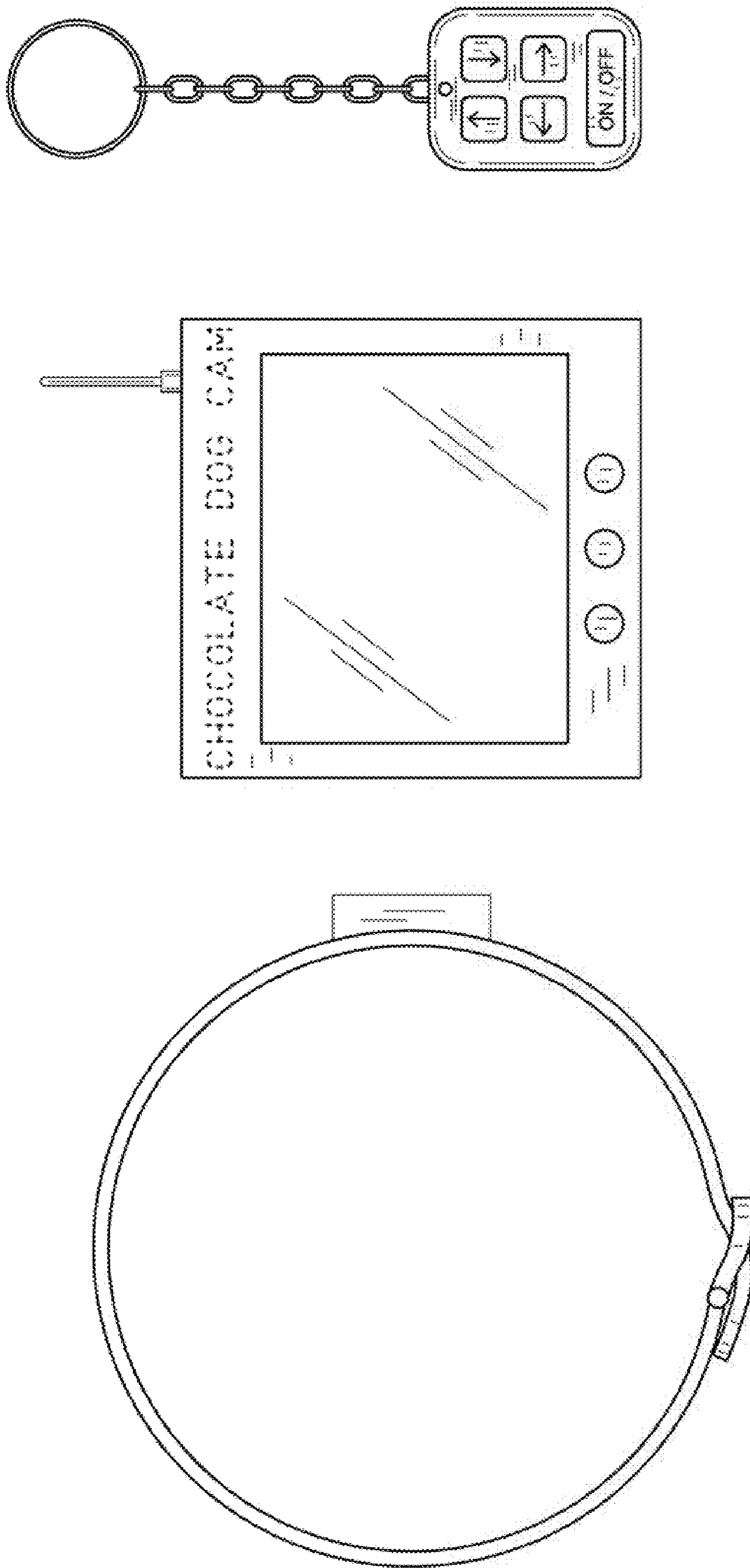
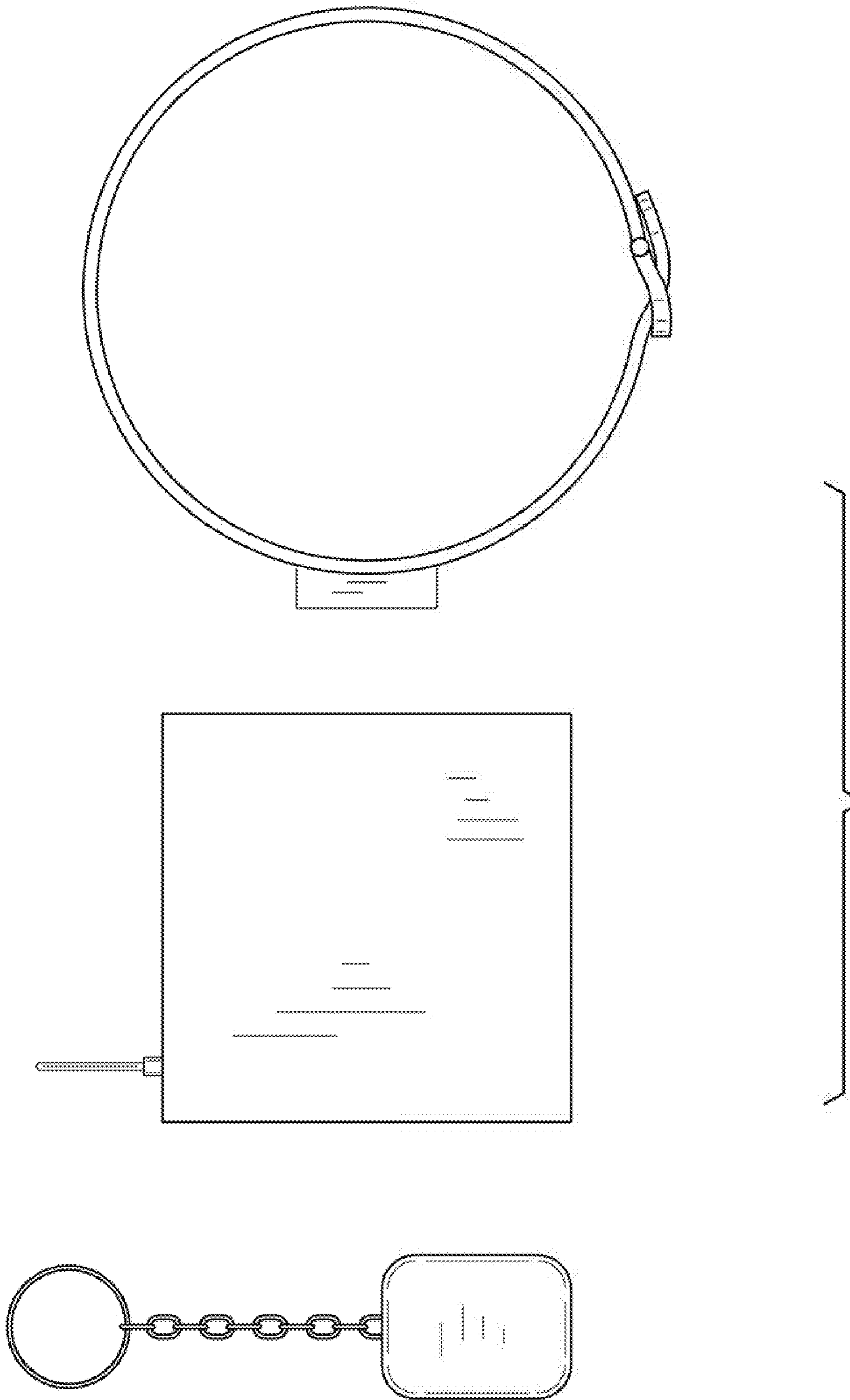

FIG. 1



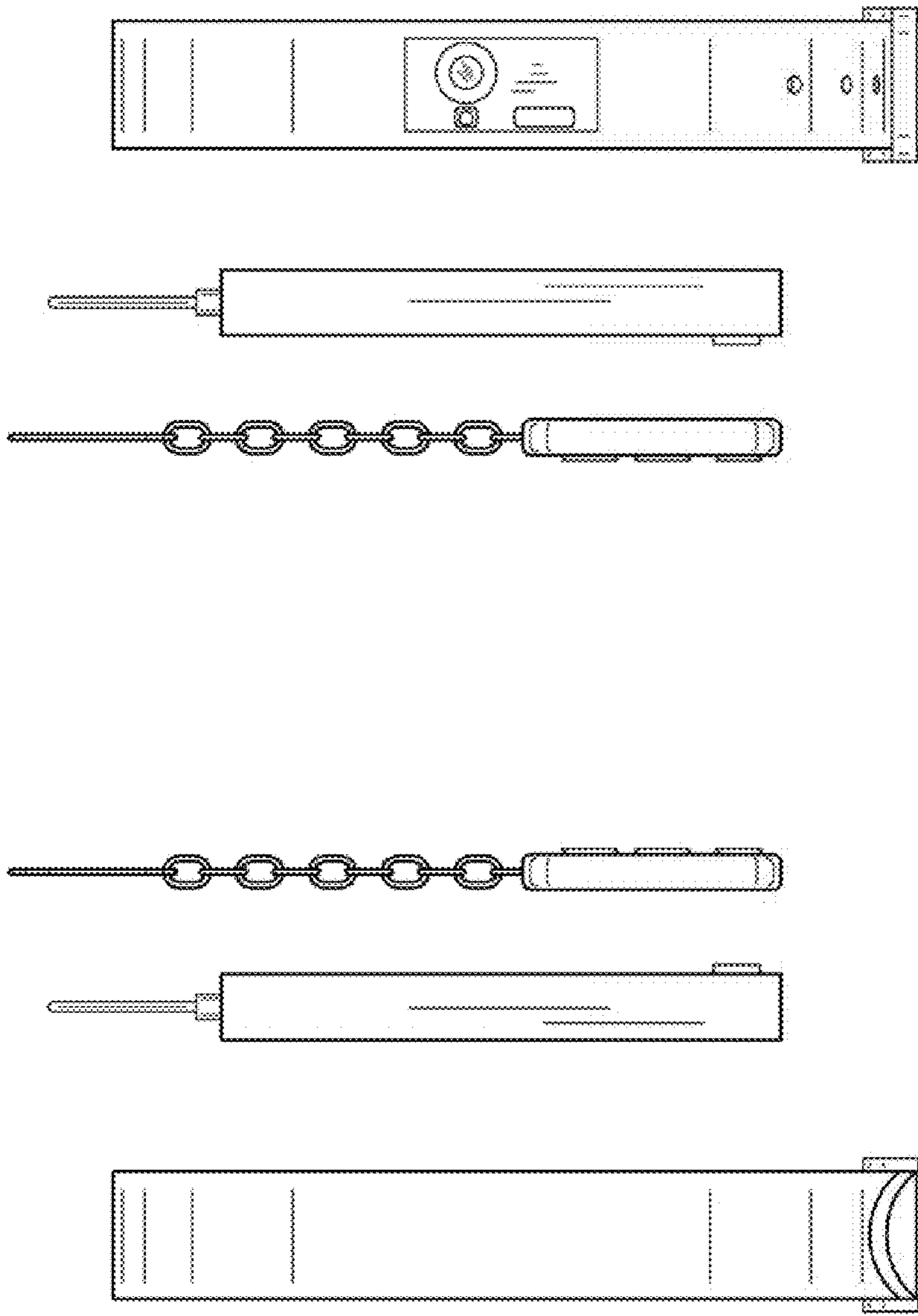

FIG. 4

FIG. 3

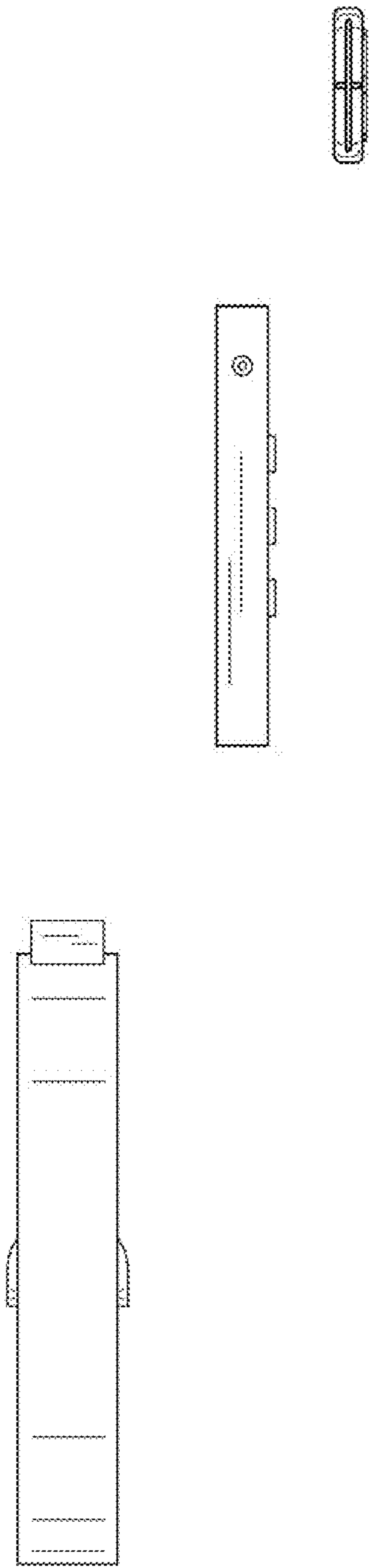

FIG. 5

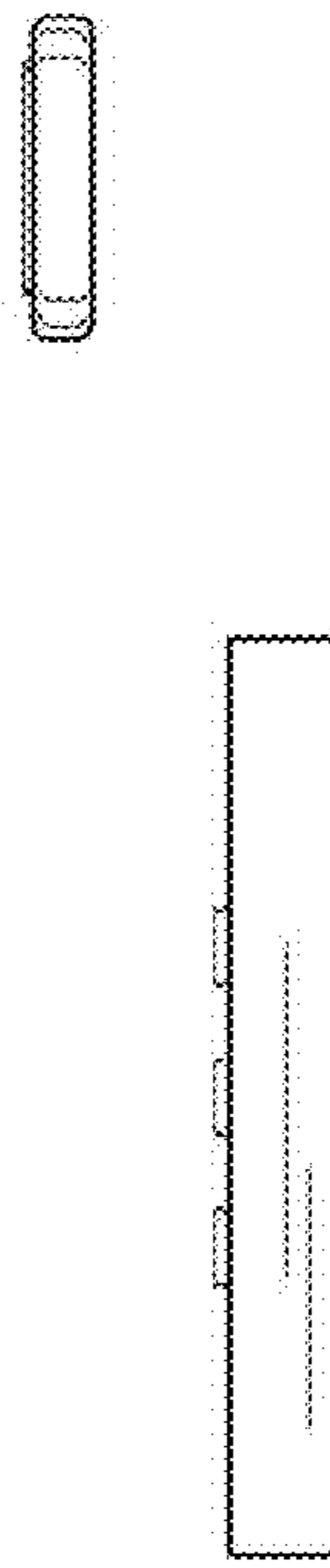

FIG. 6