



US00D635140S

(12) **United States Design Patent**
Tsai et al.

(10) **Patent No.:** **US D635,140 S**
(45) **Date of Patent:** **** Mar. 29, 2011**

(54) **DISPLAY**

(75) Inventors: **Yao-Hsing Tsai**, Zhonghe (TW);
Chih-Hui Shen, Zhonghe (TW);
Zhao-Rong Zhuz, Zhonghe (TW)

(73) Assignee: **Top Victory Investments Ltd.**, Harbour
(HK)

(**) Term: **14 Years**

(21) Appl. No.: **29/359,539**

(22) Filed: **Apr. 13, 2010**

(51) **LOC (9) Cl.** **14-02**

(52) **U.S. Cl.** **D14/374**

(58) **Field of Classification Search** D14/371-376,
D14/125-129; 345/104, 156, 168, 173, 87,
345/1.1, 901-905; 341/12; 348/180, 184,
348/325, 739; 349/1, 2, 11, 58; 248/917-924,
248/278.1; 361/679.23, 679.08
See application file for complete search history.

(56) **References Cited**

U.S. PATENT DOCUMENTS

6,381,125 B1 * 4/2002 Mizoguchi et al. 361/679.08
D494,941 S * 8/2004 Kim D14/126
6,807,051 B2 * 10/2004 Takahashi 361/679.23

D544,861 S * 6/2007 Hwang D14/375
D551,186 S * 9/2007 Yang et al. D14/126
D556,160 S * 11/2007 Lee et al. D14/126
D595,295 S * 6/2009 Shim D14/374
2004/0217244 A1 * 11/2004 Wu et al. 248/278.1
2005/0041379 A1 * 2/2005 Jang 361/681

* cited by examiner

Primary Examiner — Freda S Nunn

(74) *Attorney, Agent, or Firm* — Alan Kamrath; Kamrath &
Associates PA

(57) **CLAIM**

The ornamental design for display, as shown and described.

DESCRIPTION

FIG. 1 is a perspective view of a display showing our new design;
FIG. 2 is a front side elevational view thereof;
FIG. 3 is a rear side elevational view thereof;
FIG. 4 is a left elevational view thereof;
FIG. 5 is a right elevational view thereof;
FIG. 6 is a top plan view thereof;
FIG. 7 is a bottom plan view thereof; and,
FIG. 8 is a rear perspective view thereof.

1 Claim, 8 Drawing Sheets

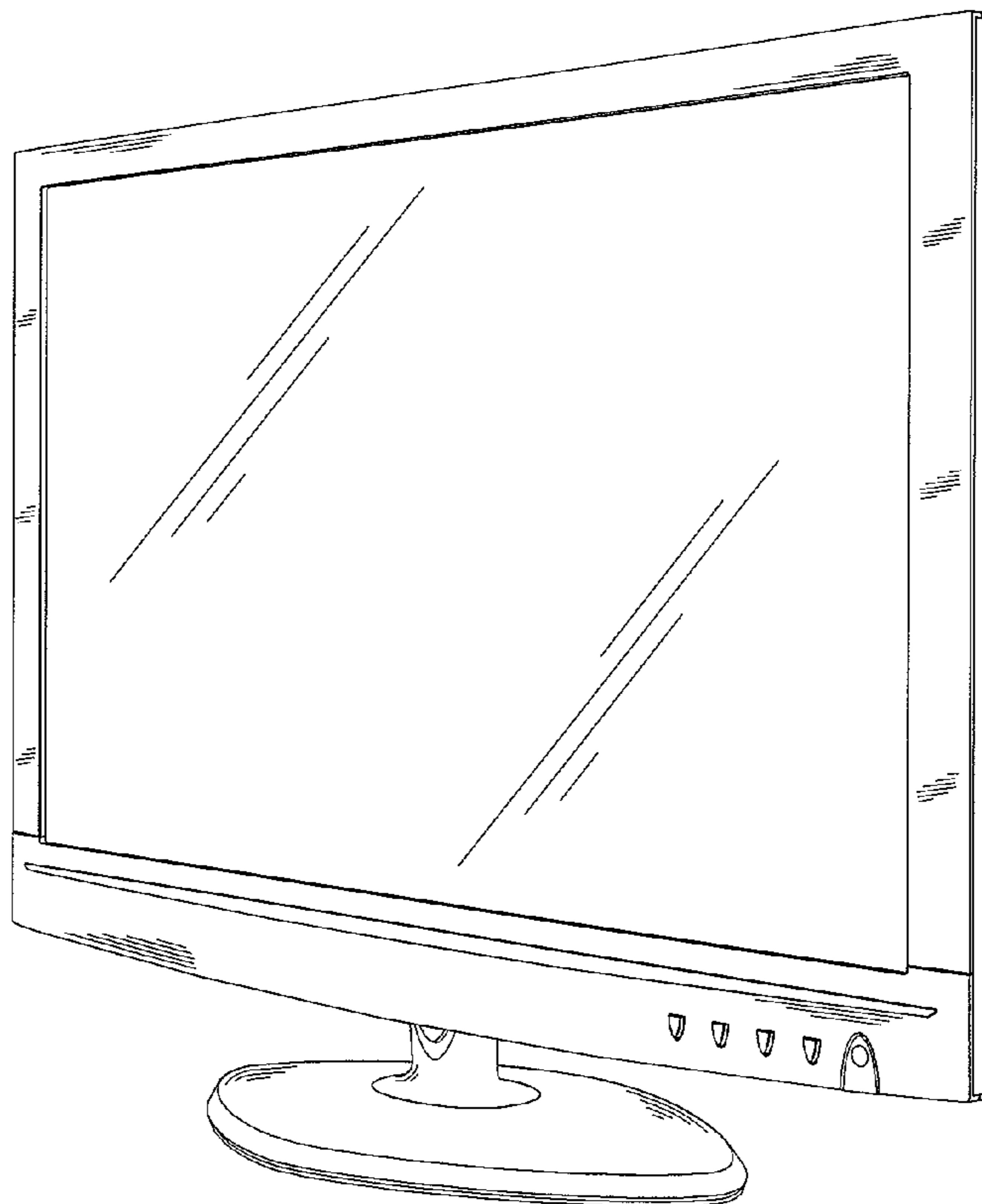

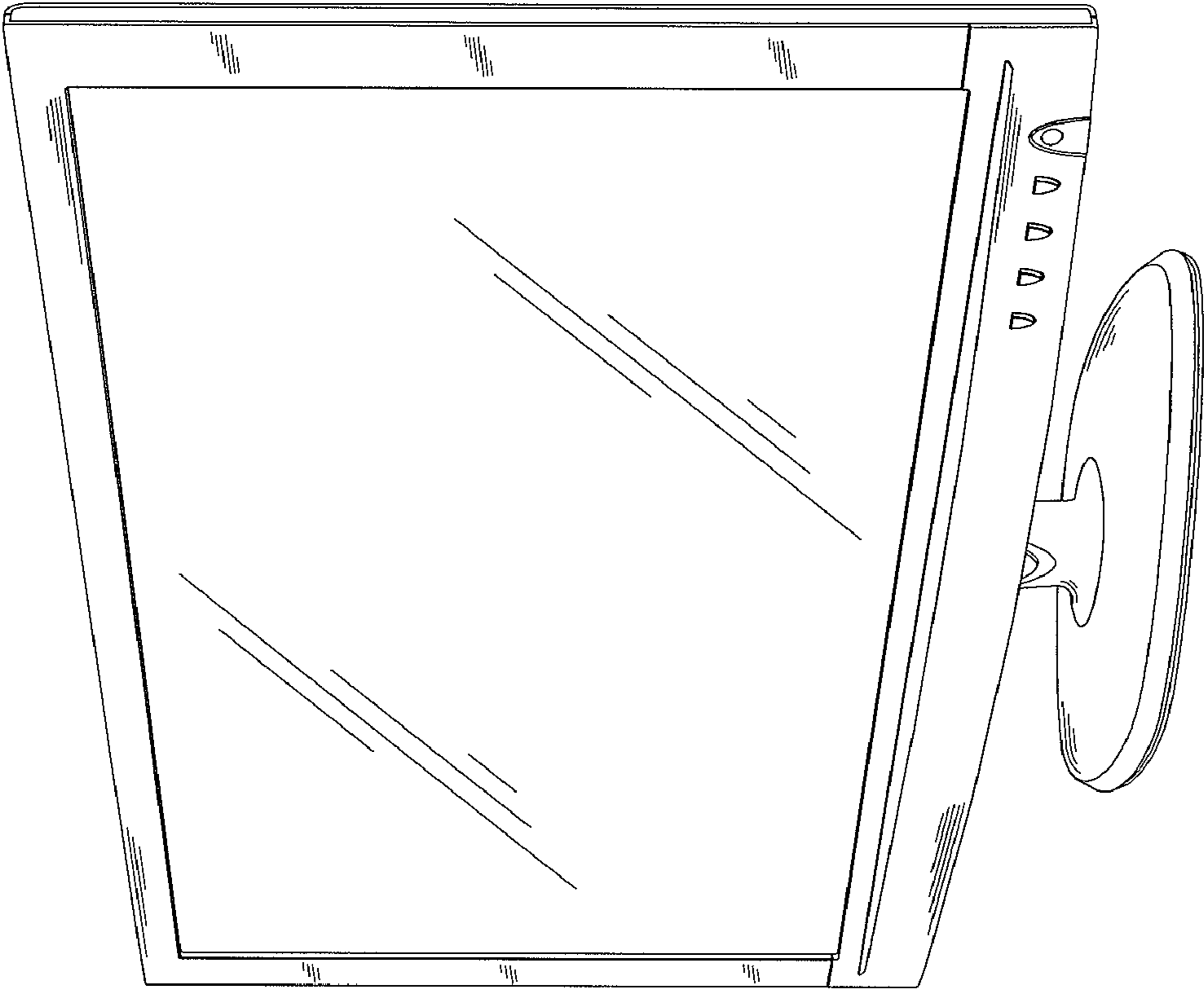

Fig. 1

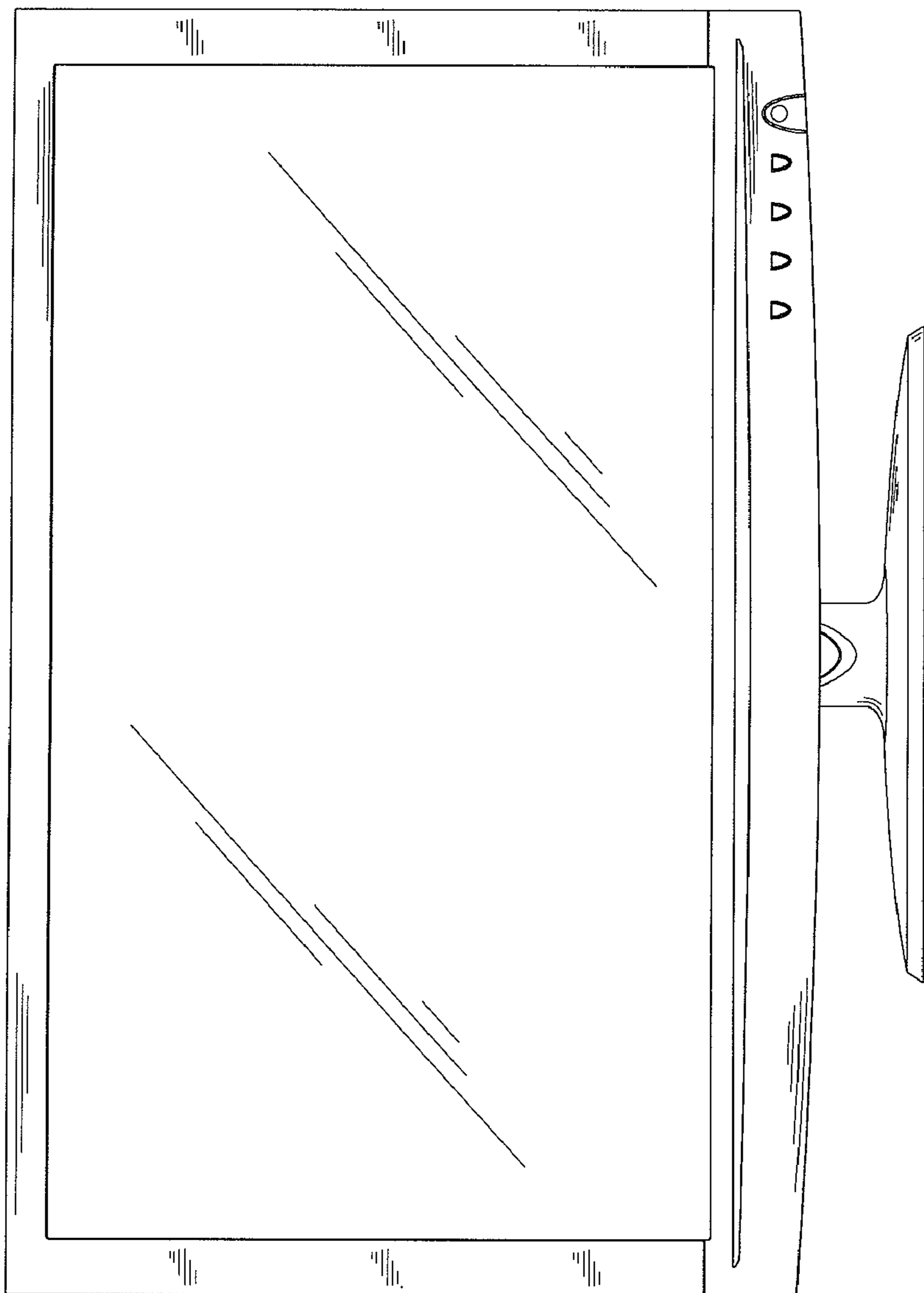

Fig. 2

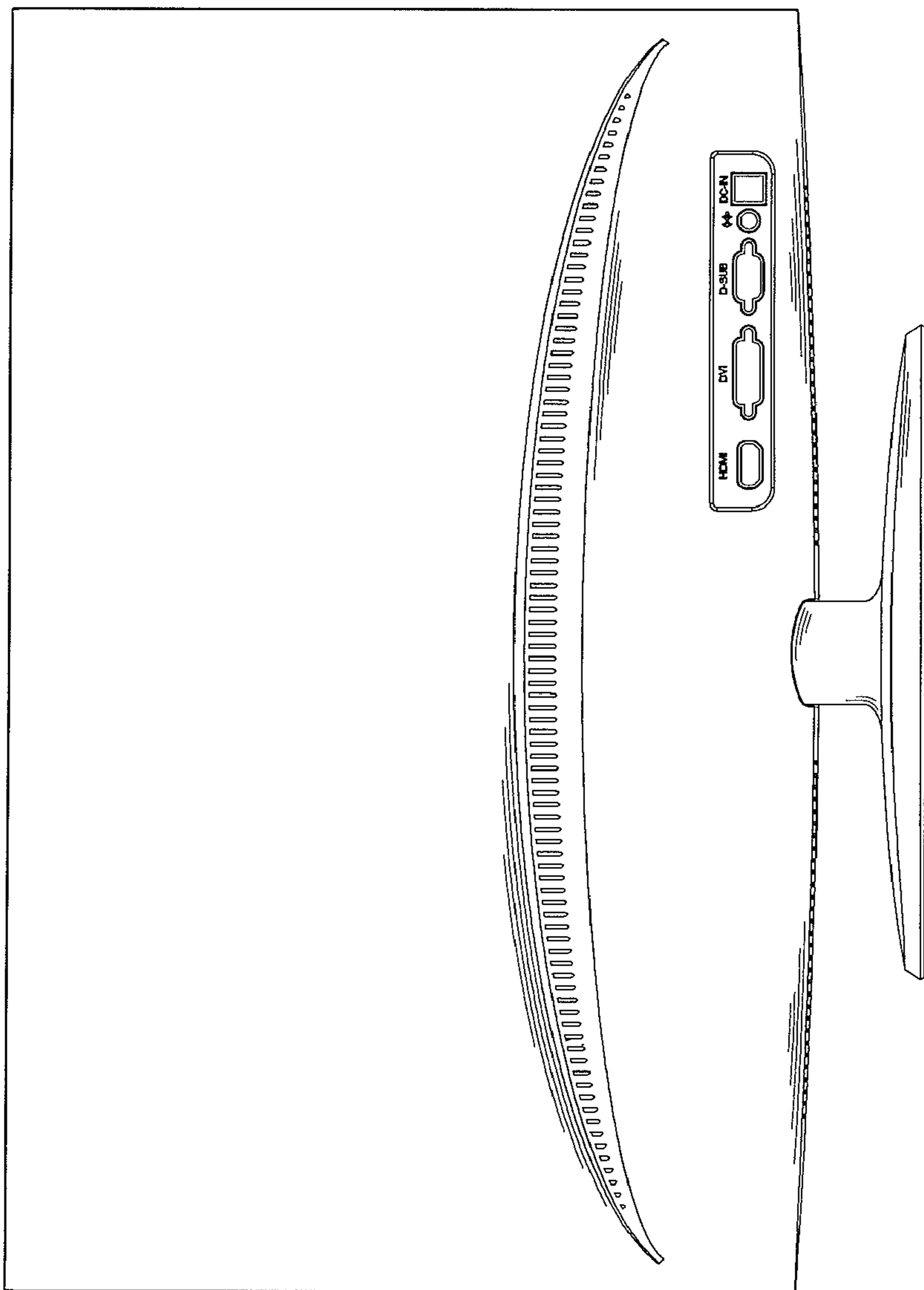

Fig. 3

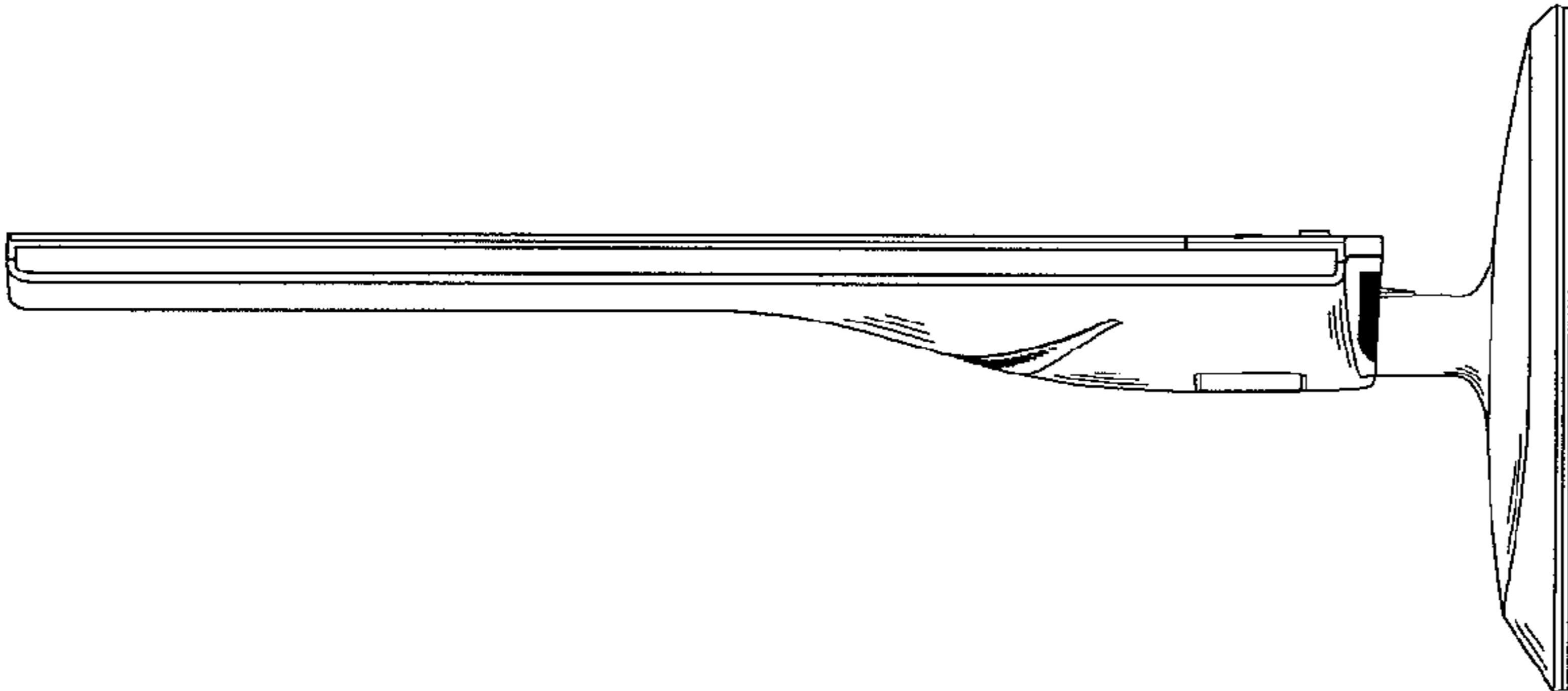

Fig. 4

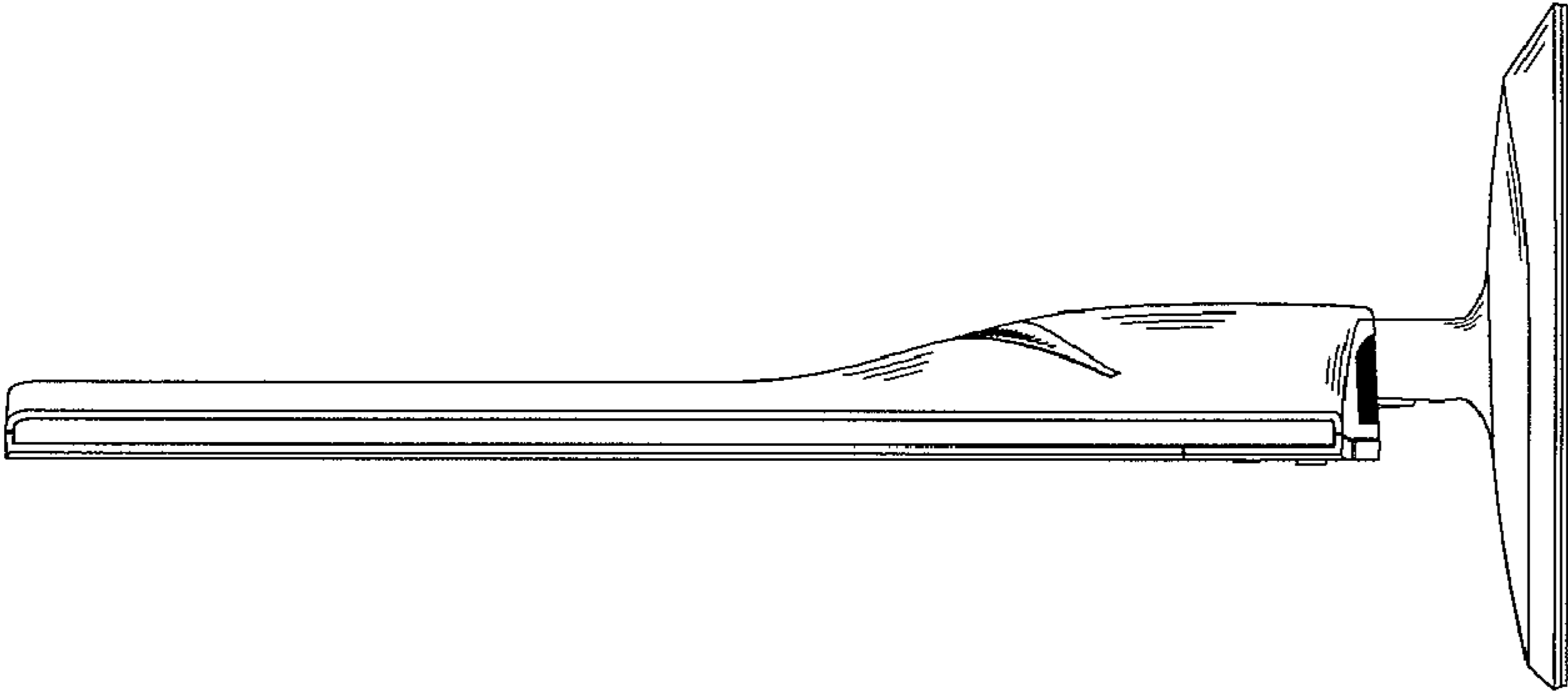

Fig. 5

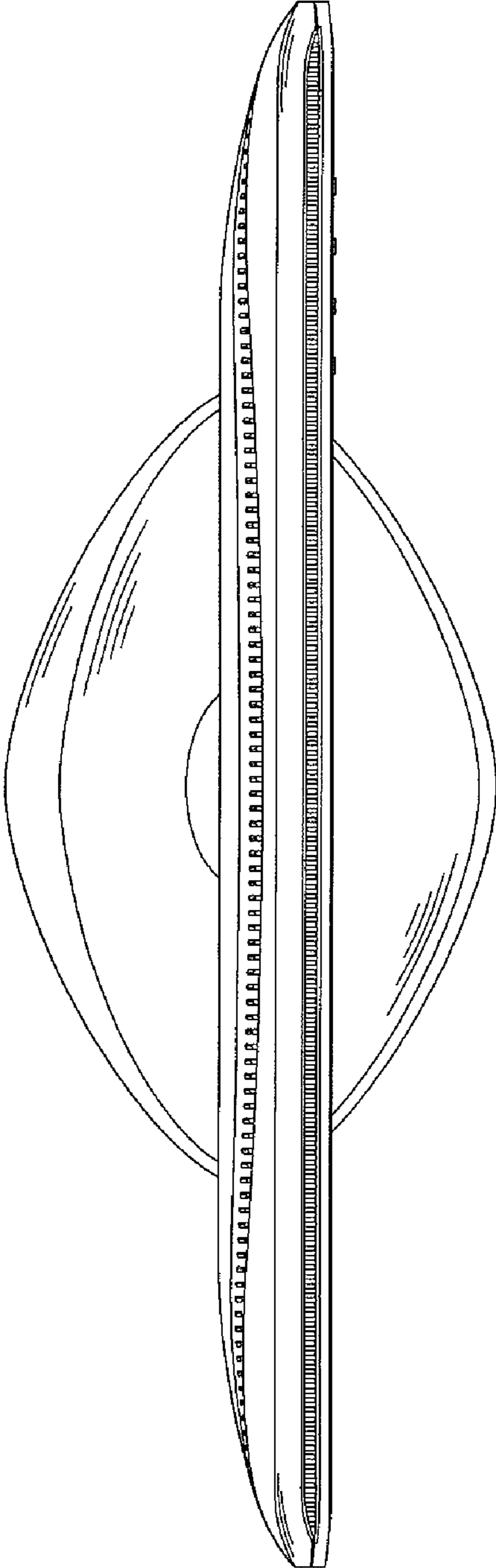

Fig. 6

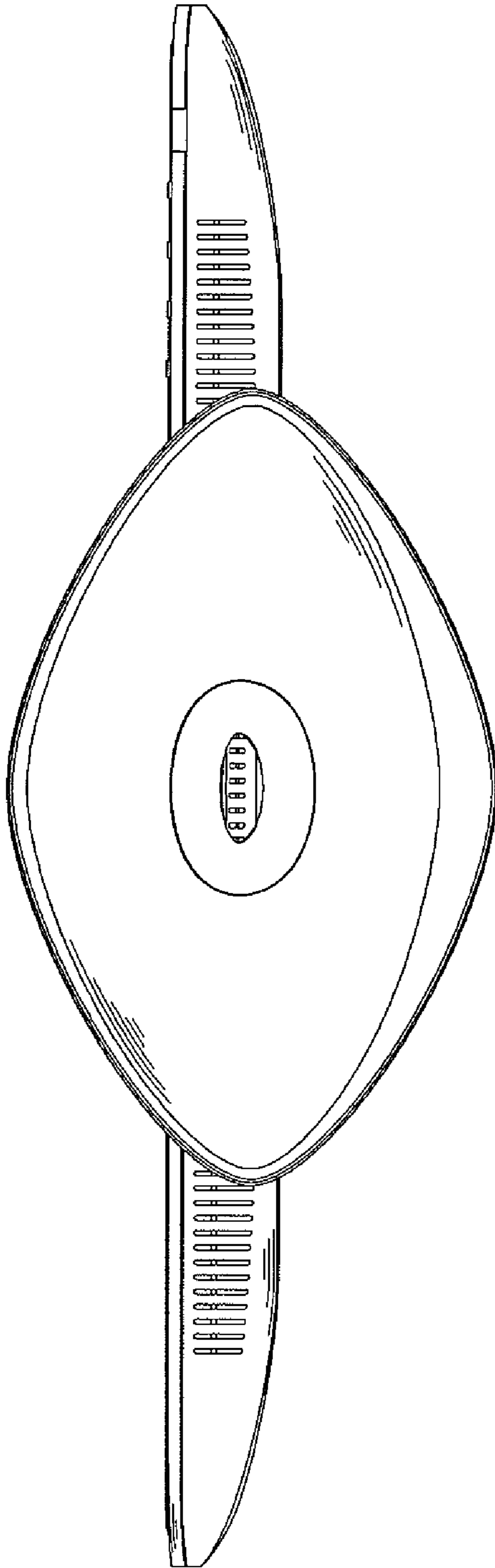

Fig. 7

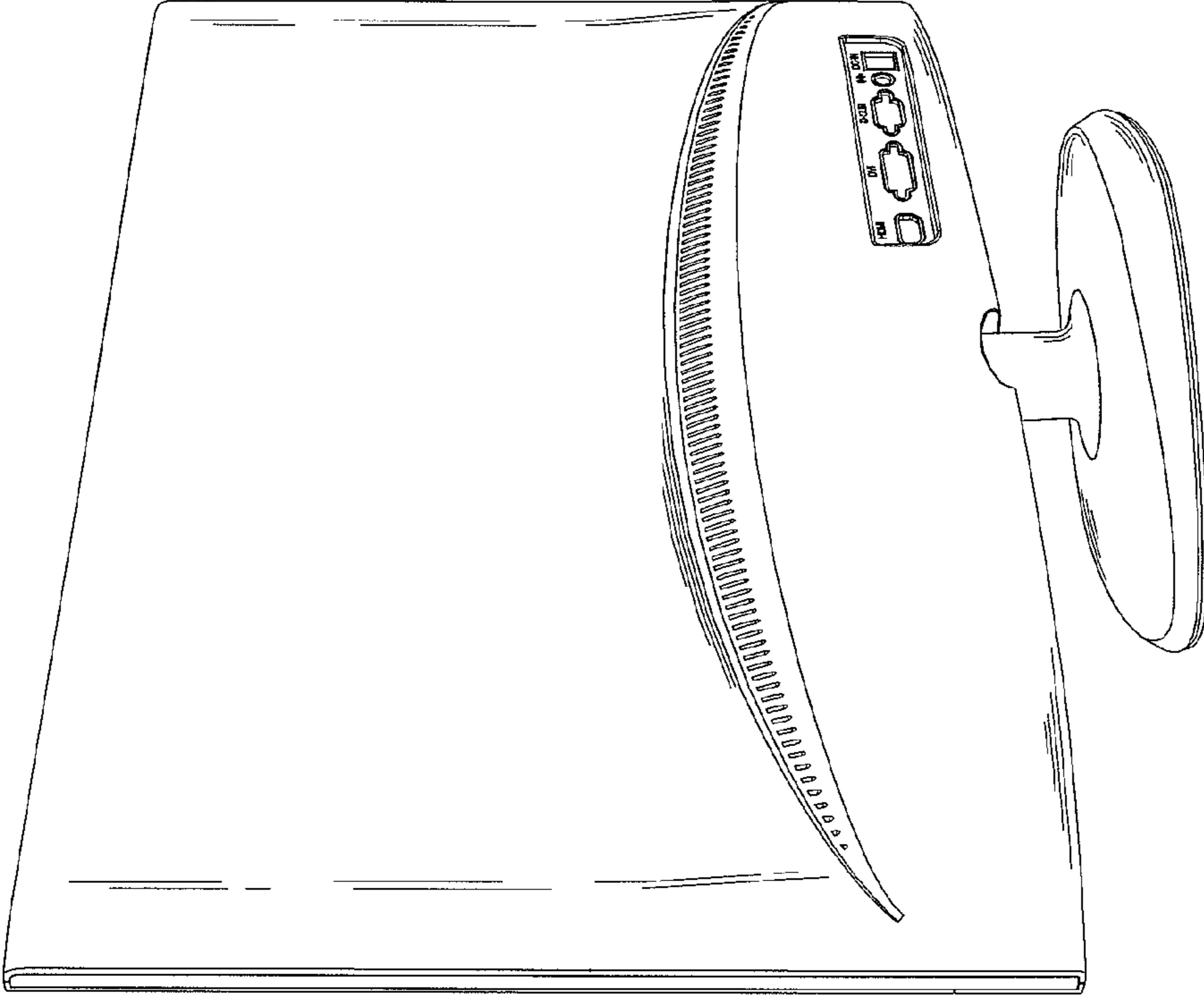

Fig. 8