



US00D635072S

(12) **United States Design Patent**
Chen

(10) **Patent No.:** **US D635,072 S**

(45) **Date of Patent:** **** Mar. 29, 2011**

(54) **BICYCLE BAR END**

(76) Inventor: **Tsung-Wei Chen**, Xihu Township (TW)

(**) Term: **14 Years**

(21) Appl. No.: **29/376,684**

(22) Filed: **Oct. 10, 2010**

(51) **LOC (9) Cl.** **12-16**

(52) **U.S. Cl.** **D12/178**

(58) **Field of Classification Search** D12/111,
D12/114, 174, 178; 280/274, 281.1, 288.2-288.4,
280/279; D8/303, 107, 300; 74/551.1-551.9
See application file for complete search history.

(56) **References Cited**

U.S. PATENT DOCUMENTS

D366,015 S *	1/1996	McCormack	D12/114
D369,772 S *	5/1996	Newkirk	D12/178
D397,069 S *	8/1998	Newkirk	D12/178
D422,536 S *	4/2000	Marshall	D12/114
D434,356 S *	11/2000	Giard	D12/178
D435,002 S *	12/2000	Giard	D12/178

D457,473 S *	5/2002	Shirey	D12/178
D457,474 S *	5/2002	Shirey	D12/178
D496,892 S *	10/2004	Shirey	D12/178

* cited by examiner

Primary Examiner — Susan M Lee

Assistant Examiner — Linda G. Brooks

(57) **CLAIM**

The ornamental design for a bicycle bar end, as shown and described.

DESCRIPTION

FIG. 1 is a perspective view of a bicycle bar end showing my new design;
 FIG. 2 is a front view of FIG. 1;
 FIG. 3 is a rear view of FIG. 1;
 FIG. 4 is a left side view of FIG. 1;
 FIG. 5 is a right side view of FIG. 1;
 FIG. 6 is a top view of FIG. 1;
 FIG. 7 is a bottom view of FIG. 1; and,
 FIG. 8 is a perspective view illustrating an application of a bicycle bar end showing my design.
 The broken lines in FIG. 8 illustrate environmental structure that forms no part of the claimed design.

1 Claim, 7 Drawing Sheets

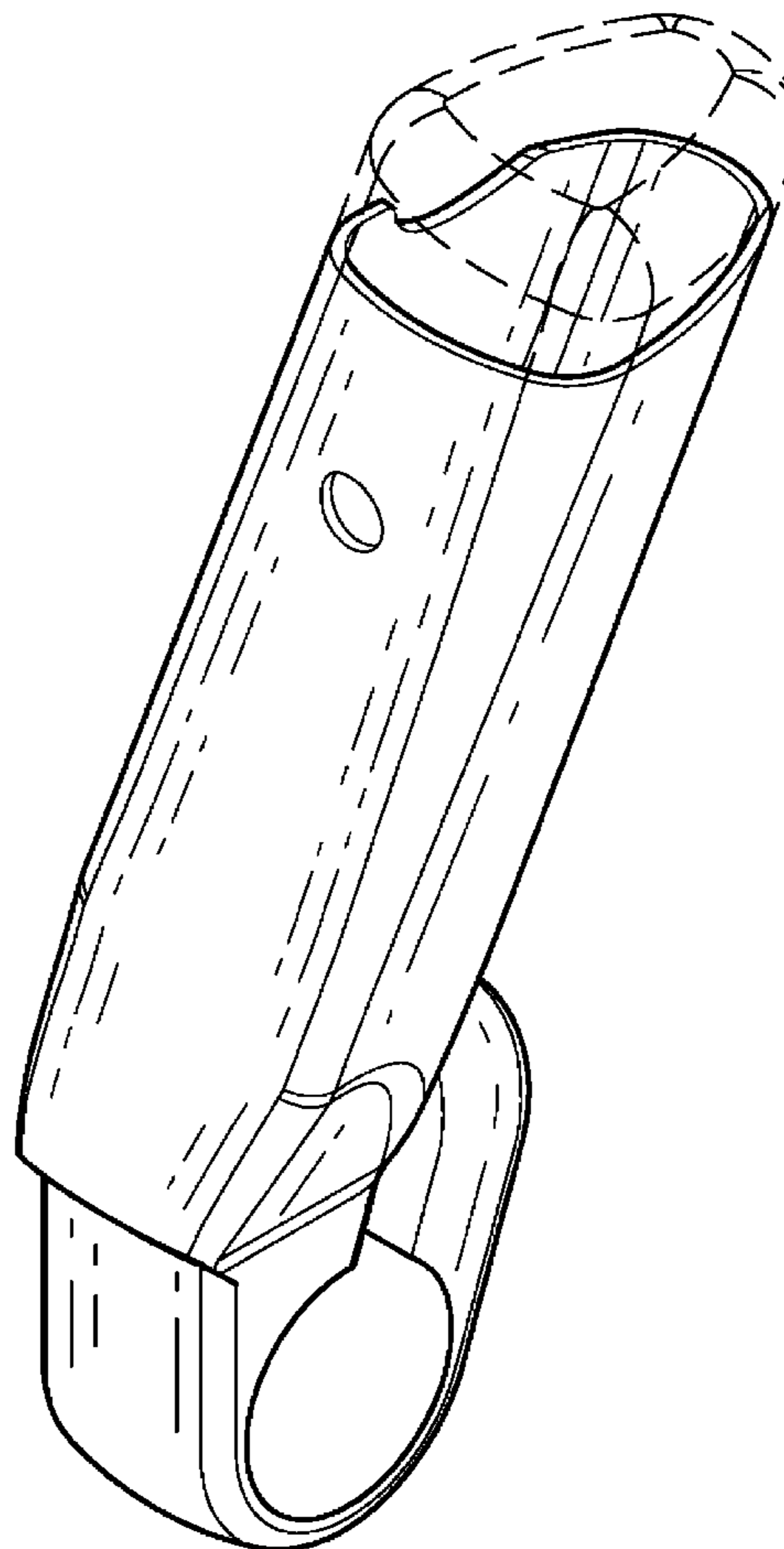
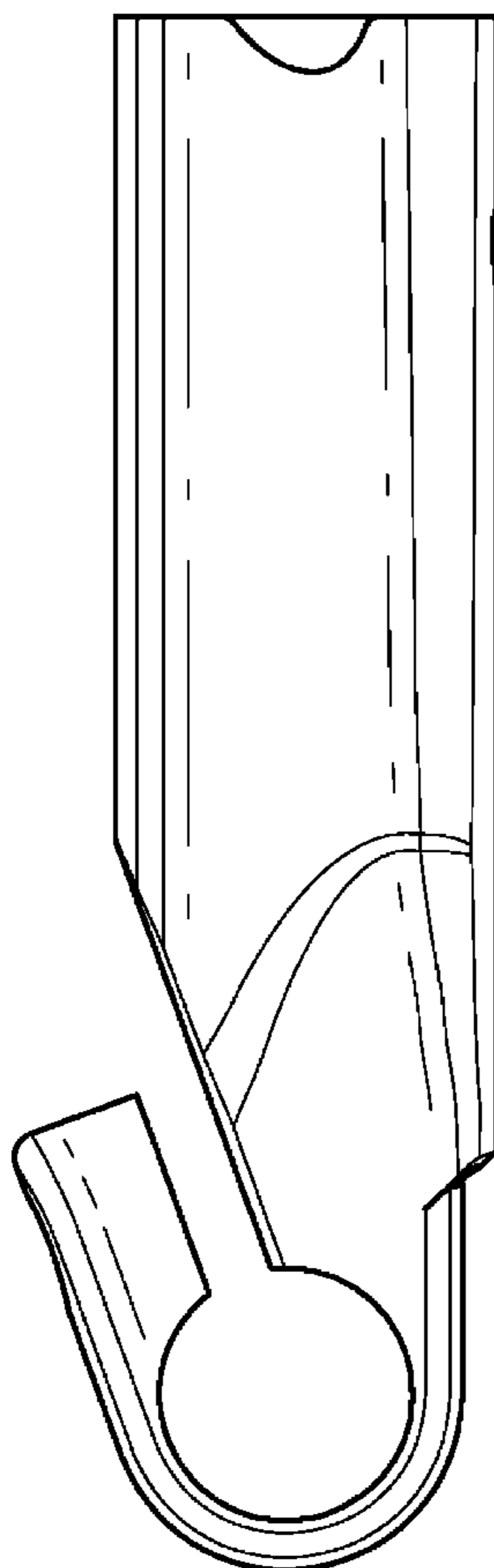

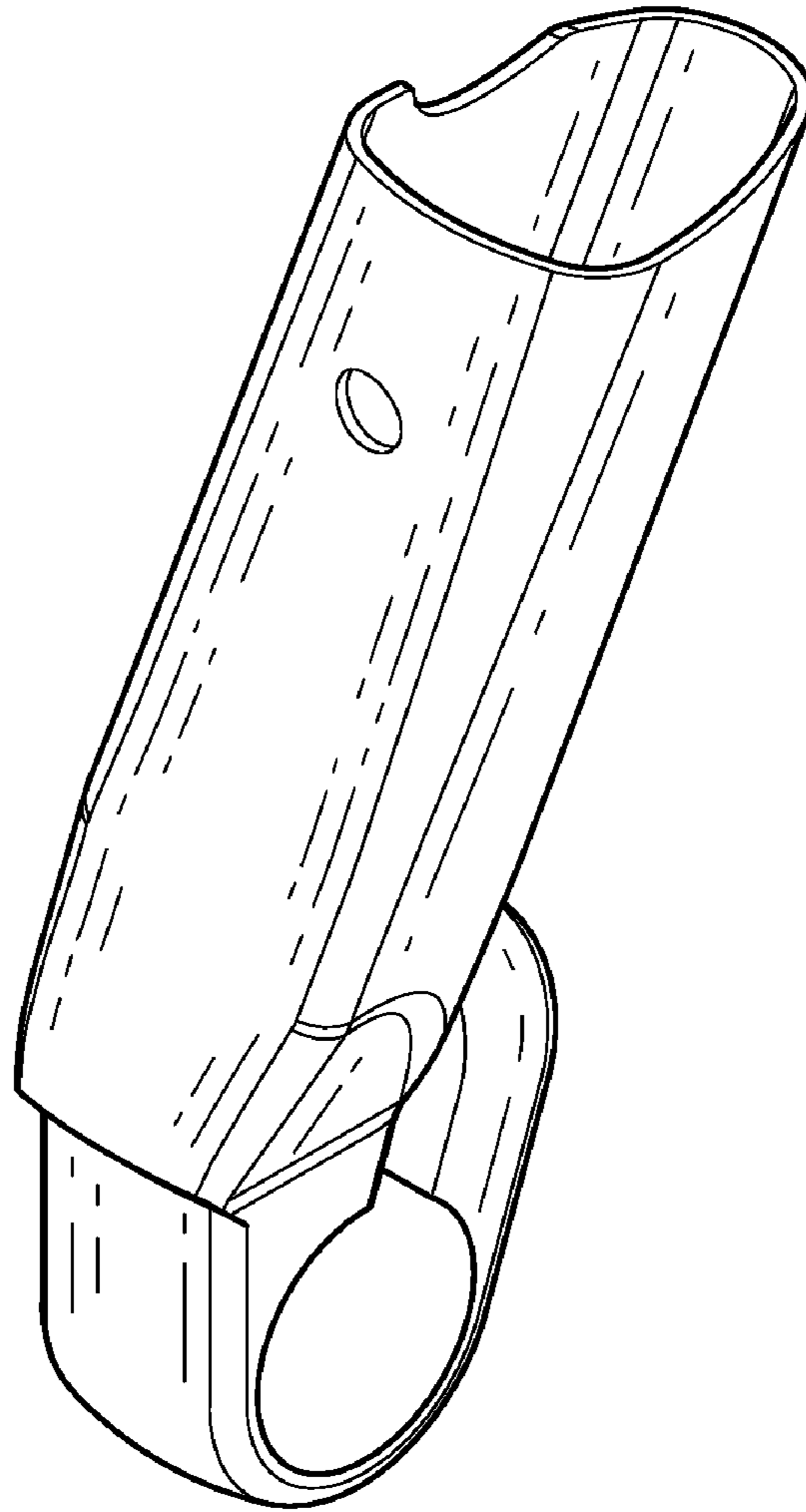

FIG. 1

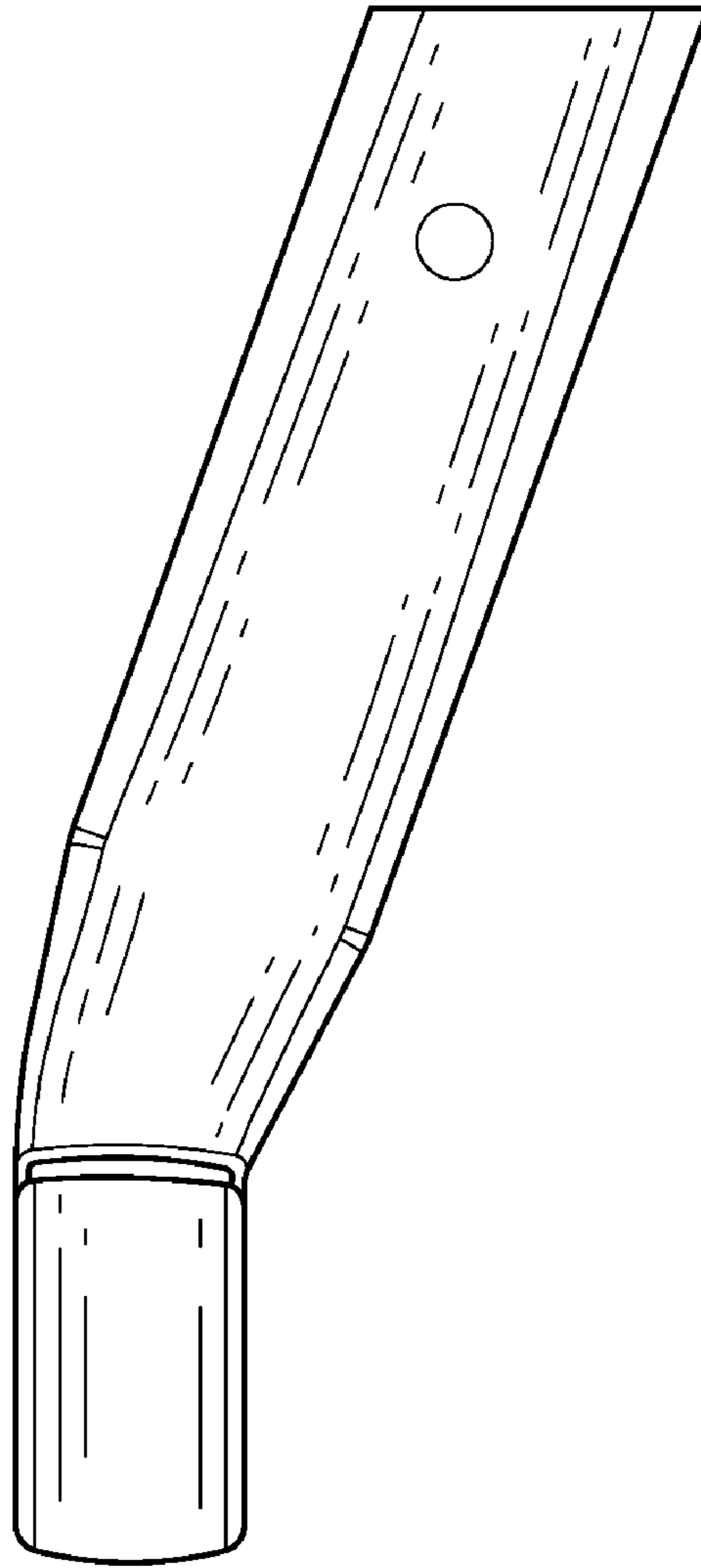

FIG. 2

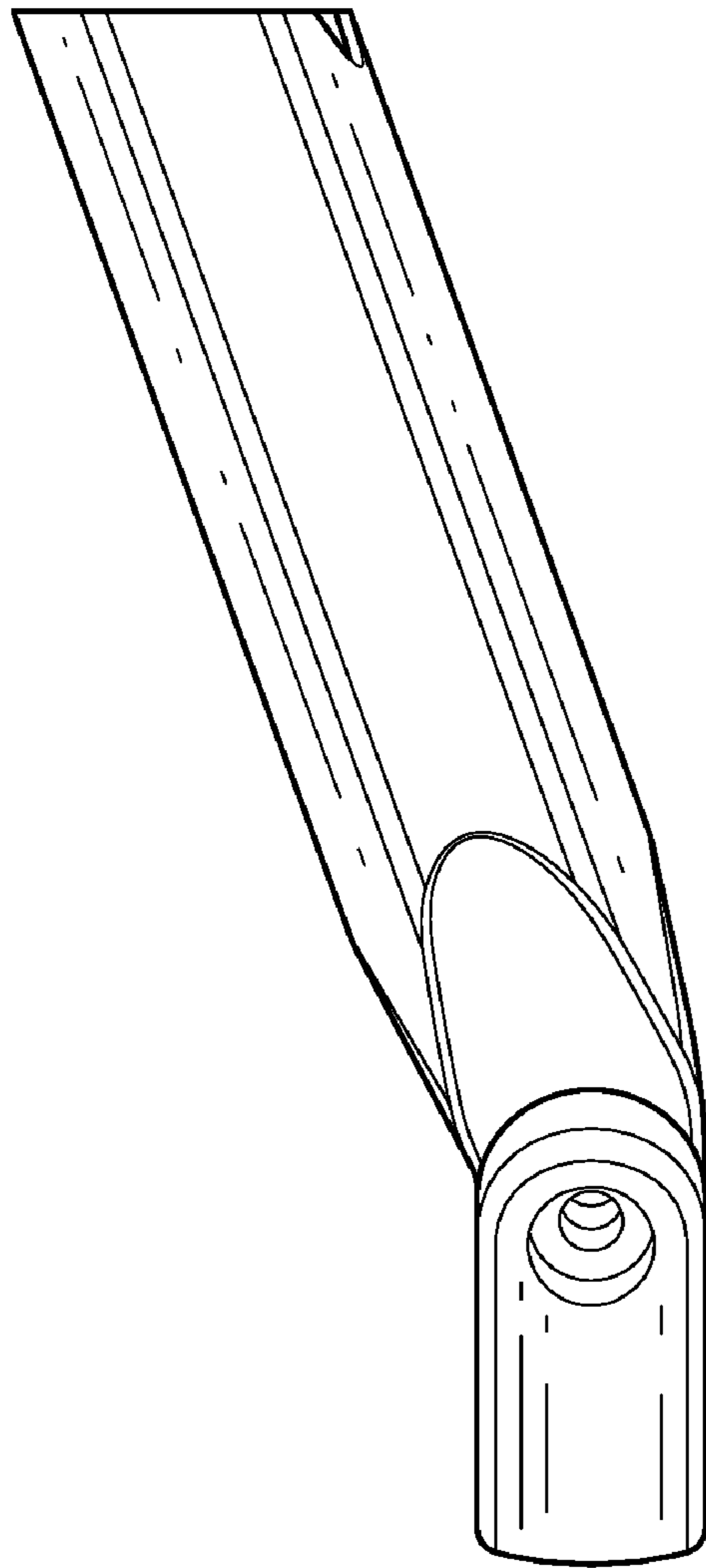

FIG. 3

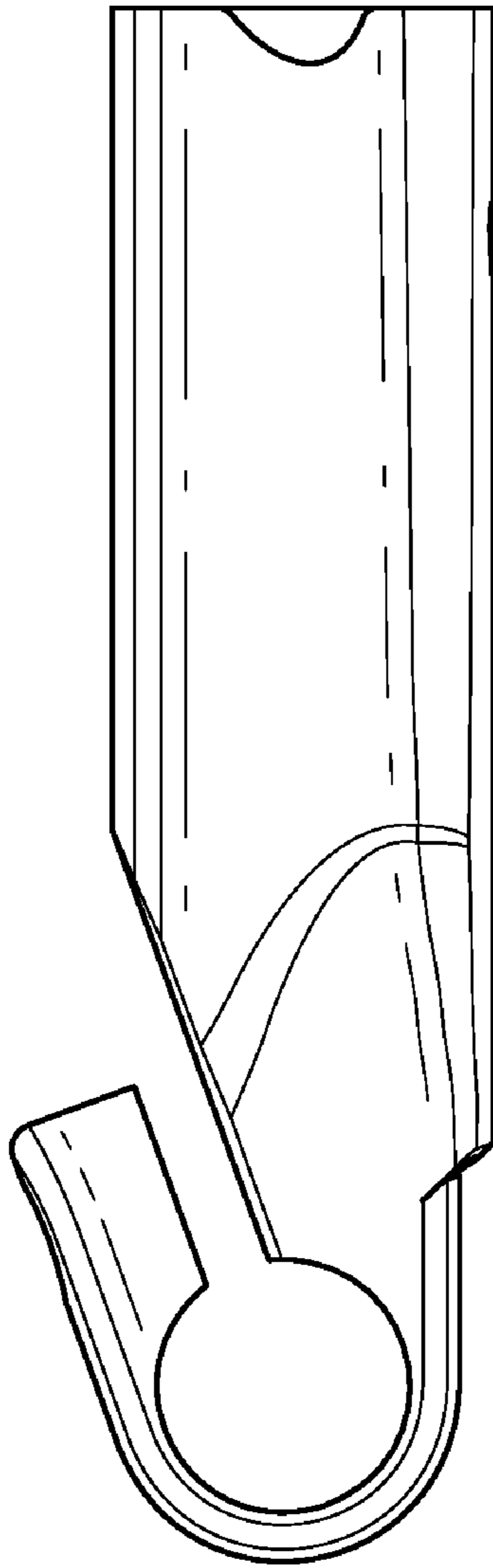

FIG. 4

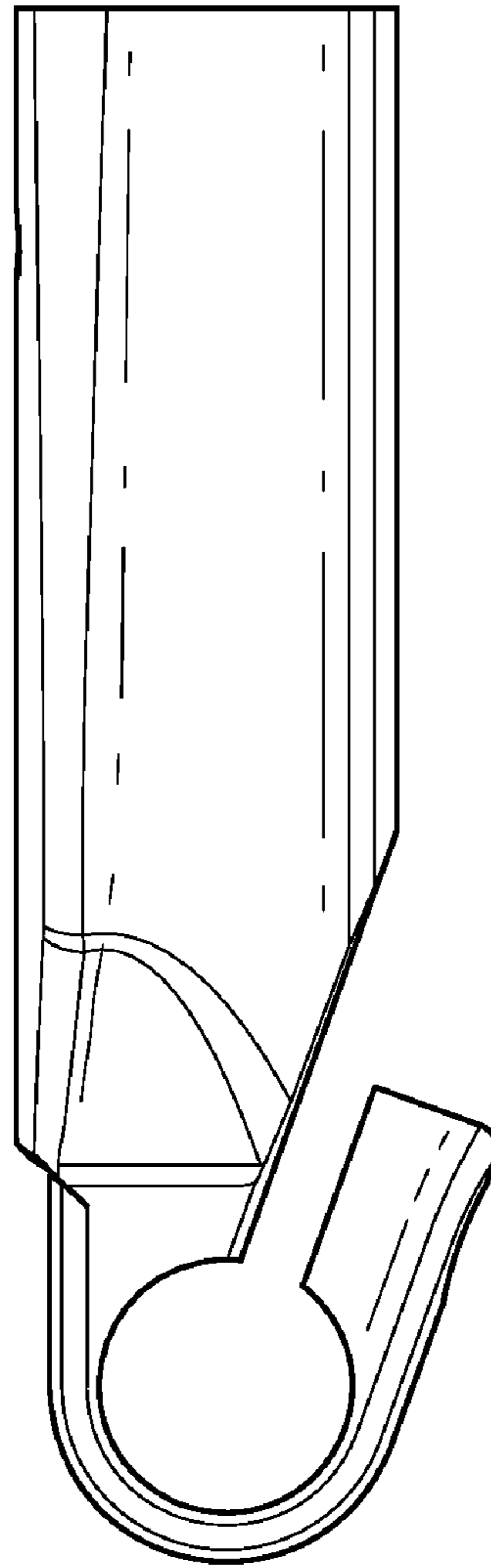

FIG. 5

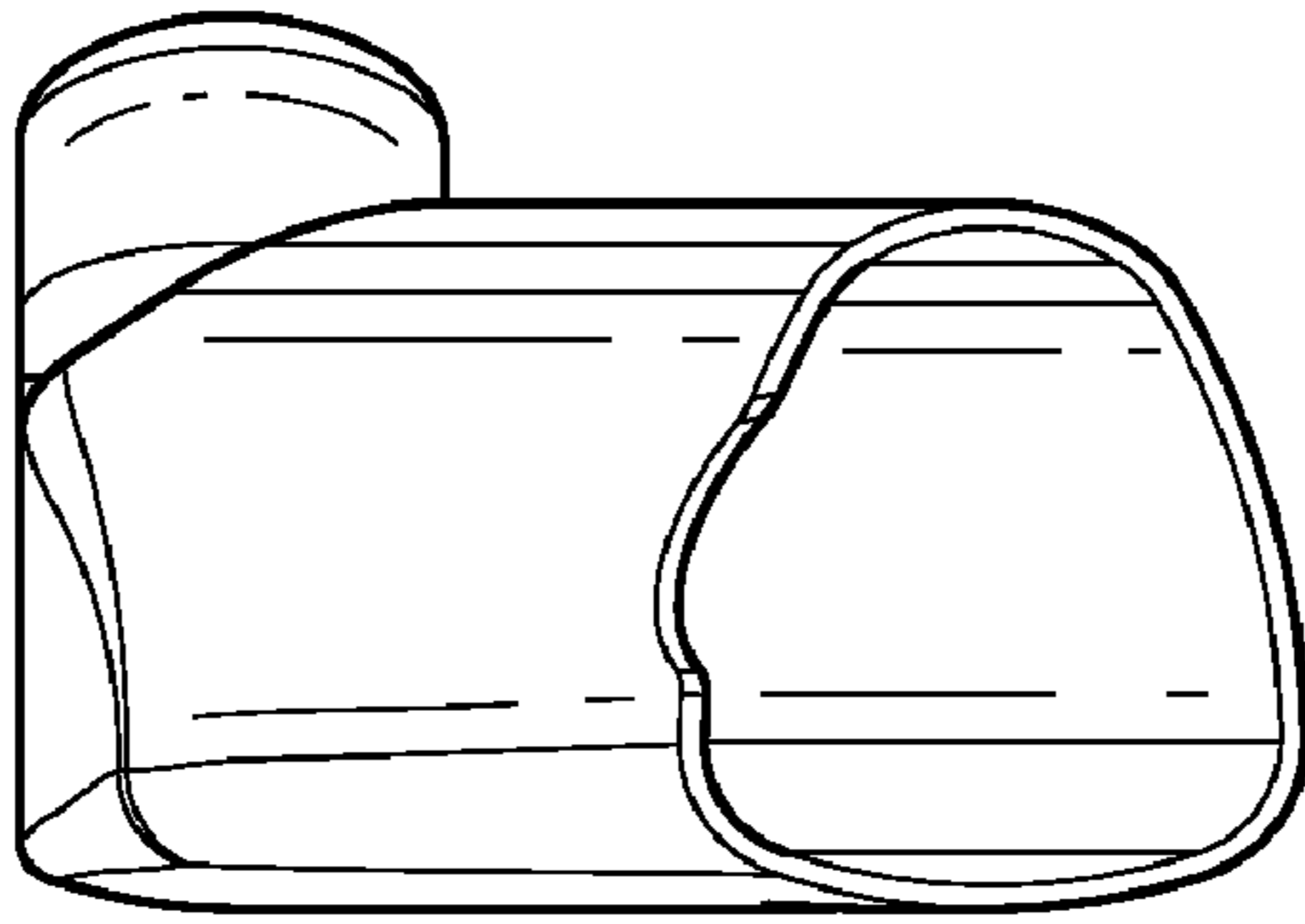

FIG. 6

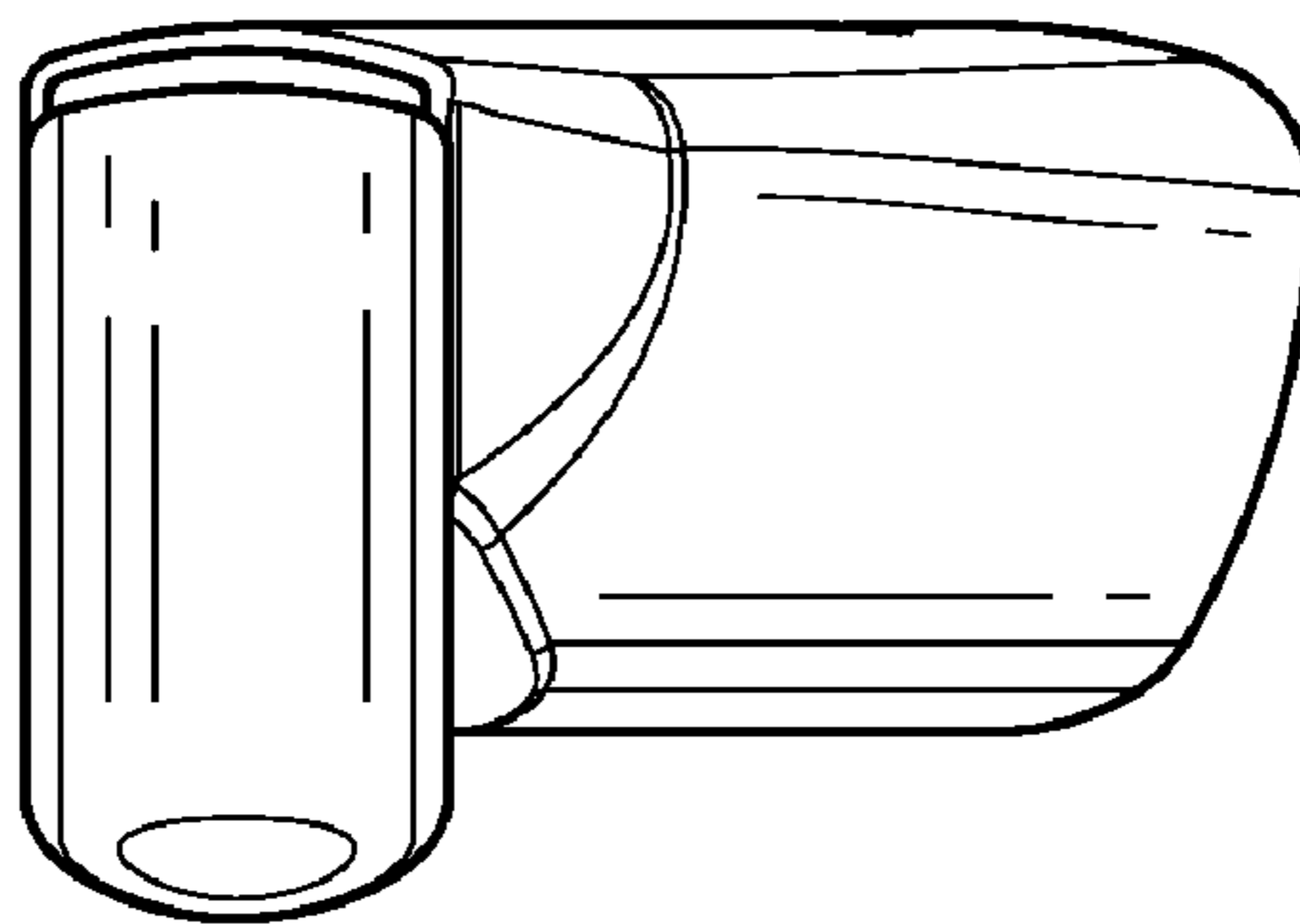

FIG. 7

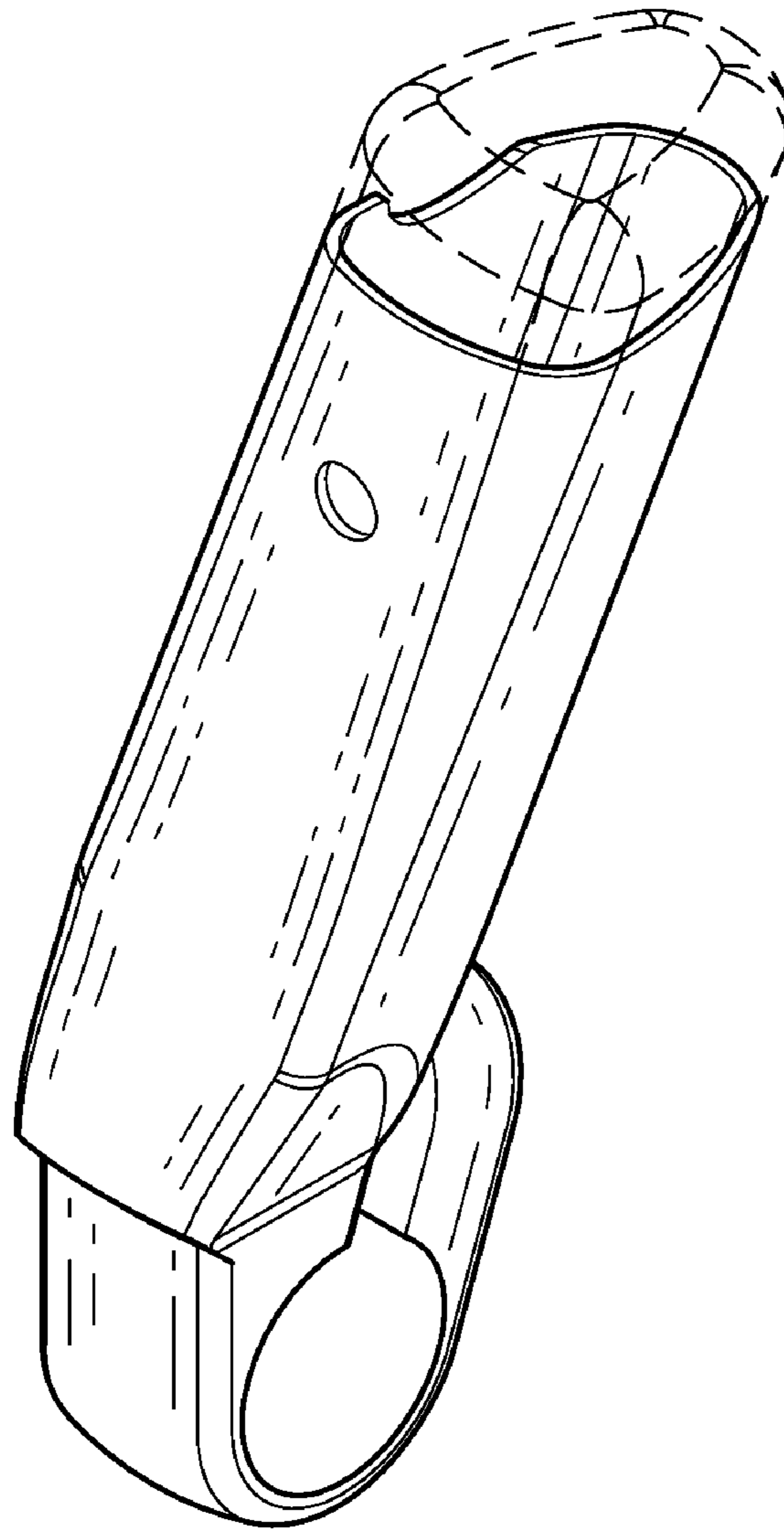

FIG. 8