



US00D635052S

(12) **United States Design Patent**
Rooney

(10) **Patent No.:** **US D635,052 S**
(45) **Date of Patent:** **** Mar. 29, 2011**

- (54) **BOX VASE**
- (75) Inventor: **Maria D. Rooney**, Auburn, NH (US)
- (73) Assignee: **Blooms in a Box, LLC**, Auburn, NH (US)
- (**) Term: **14 Years**
- (21) Appl. No.: **29/322,772**
- (22) Filed: **Aug. 12, 2008**
- (51) **LOC (9) Cl.** **11-02**
- (52) **U.S. Cl.** **D11/146; D9/432**
- (58) **Field of Classification Search** D6/403-405, D6/556; D8/1; D9/414, 430-433; D11/143-156; D19/77, 81, 84; D26/9, 16, 19; D34/1-11; 47/32.7, 33, 39, 41.01, 41.1, 41.11-41.15, 47/44-47, 65.5, 65.9, 66.1, 66.6, 66.7, 67-71
See application file for complete search history.

5,771,614 A 6/1998 Dawson
 5,836,095 A 11/1998 Crowell
 D406,058 S * 2/1999 Allmon D9/433
 (Continued)

OTHER PUBLICATIONS

New Hampshire Union Leader, Sunday News, Apr. 27, 2003, Home and Family Section "Flower-topped box".

(Continued)

Primary Examiner — Garth Rademaker

(74) *Attorney, Agent, or Firm* — McLane, Graf, Raulerson & Middleton, Professional Association

(57) **CLAIM**

The ornamental design for a box vase, as shown and described.

DESCRIPTION

FIG. 1 is front perspective view of a box vase showing a first embodiment of my new design;
 FIG. 2 is a front elevational view thereof;
 FIG. 3 is a rear elevational view thereof;
 FIG. 4 is a right-side elevational view thereof, the left-side elevational view being identical thereto;
 FIG. 5 is a top plan view thereof;
 FIG. 6 is a bottom plan view thereof;
 FIG. 7 is a fragmentary, right-side elevational view thereof;
 FIG. 8 is a front perspective view of a box vase showing a second embodiment of my new design;
 FIG. 9 is a front elevational view thereof;
 FIG. 10 is a rear elevational view thereof;
 FIG. 11 is a right-side elevational view thereof, the left-side elevational view being identical thereto;
 FIG. 12 is a top plan view thereof;
 FIG. 13 is a bottom plan view thereof; and,
 FIG. 14 is a fragmentary, right-side elevational view thereof.
 The broken lines depict environmental subject matter only and form no part of the claimed design.

(56) **References Cited**

U.S. PATENT DOCUMENTS

1,518,207 A	12/1924	McCauley	
1,885,879 A	11/1932	Whittington	
D130,646 S *	12/1941	Adams	D9/713
D170,794 S *	11/1953	DeKolb	D9/431
2,797,041 A *	6/1957	Rondone	47/84
3,153,503 A *	10/1964	Goldstein	206/216
4,014,134 A	3/1977	Womack, Jr.	
D254,844 S *	4/1980	Cravens	D9/433
4,242,835 A	1/1981	Mondragon Sorribes	
D261,617 S *	11/1981	Austin, Jr.	D9/432
4,584,213 A	4/1986	Rentowl	
4,819,803 A	4/1989	Neiser	
4,917,240 A	4/1990	Roberts et al.	
5,038,930 A	8/1991	Holtkamp, Jr.	
5,366,192 A	11/1994	Carroll	
5,435,085 A	7/1995	Johnson	
5,595,008 A	1/1997	Johnson	
5,628,396 A	5/1997	Weiner	
D380,154 S *	6/1997	Ryan	D9/432
5,682,999 A	11/1997	Larson	
5,706,947 A	1/1998	Hodges	

1 Claim, 8 Drawing Sheets

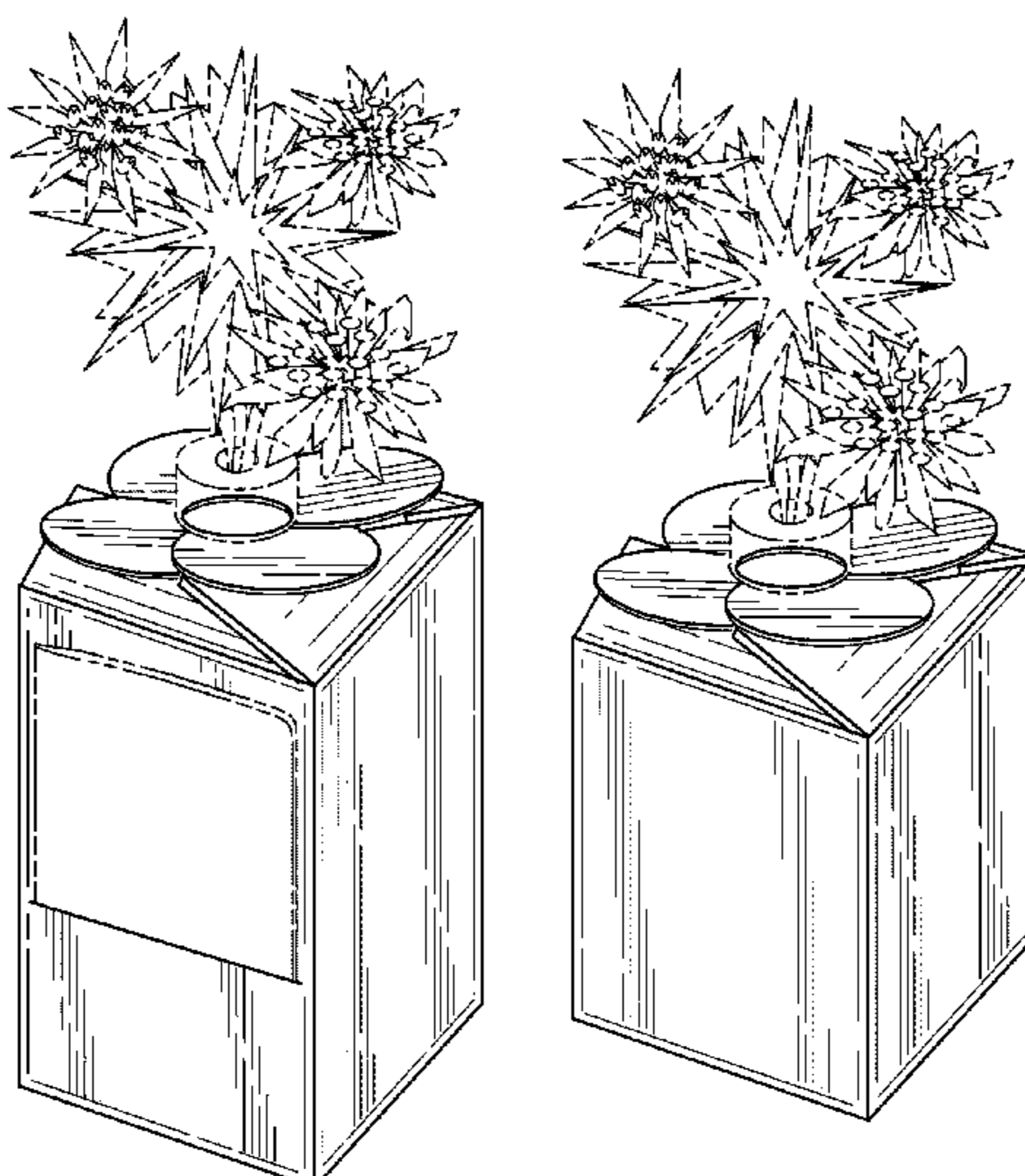

US D635,052 S

Page 2

U.S. PATENT DOCUMENTS

5,878,982 A 3/1999 Cumby et al.
D410,196 S * 5/1999 Berg D9/432
D422,027 S 3/2000 Weiner
6,061,955 A 5/2000 Domstein
6,138,828 A 10/2000 Bendix
6,237,788 B1 5/2001 Shuen
D456,710 S * 5/2002 Persson D9/431
6,423,740 B1 7/2002 Campbell
D469,691 S * 2/2003 Brondyke et al. D9/431

D522,404 S * 6/2006 Kerdil D11/143
2003/0168369 A1 9/2003 Kroeze et al.
2005/0155902 A1 7/2005 Rooney

OTHER PUBLICATIONS

Real Simple Magazine, Oct. 2002, Solutions Section, "Product of the Month—Pop Art".

* cited by examiner

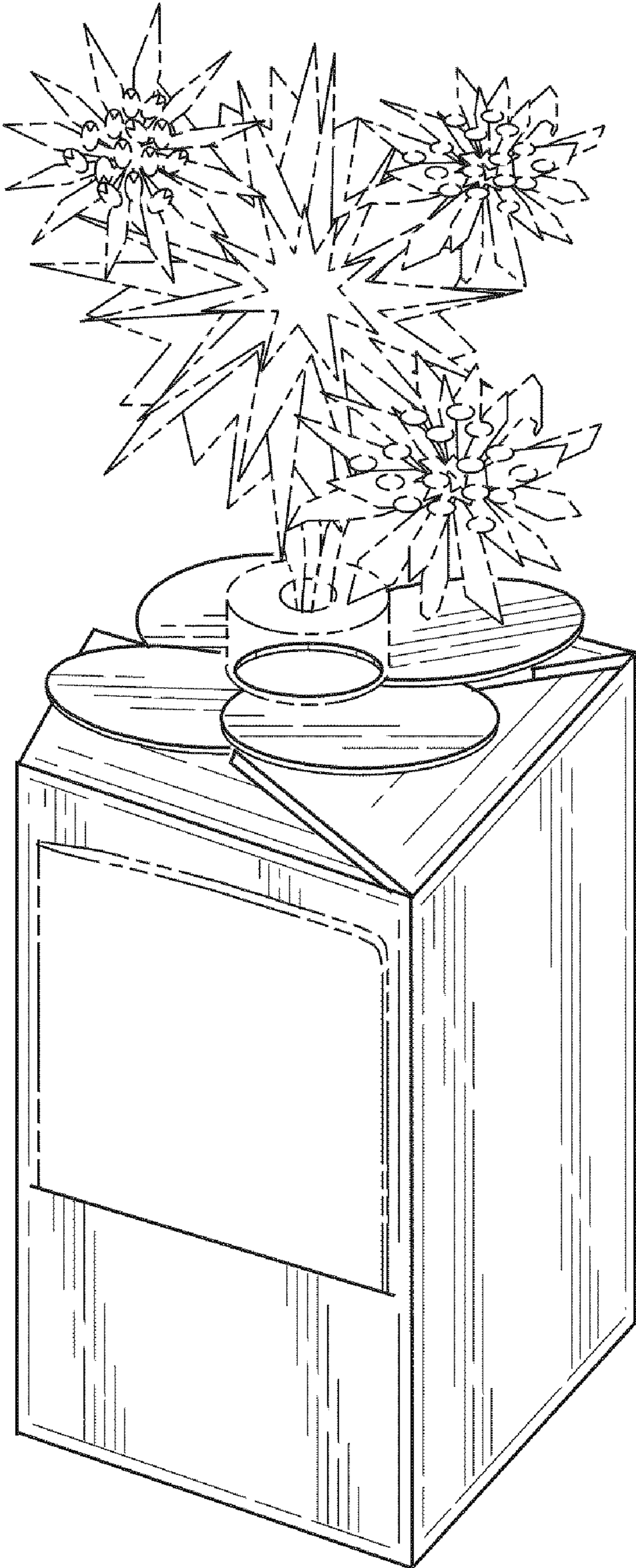

FIG. 1

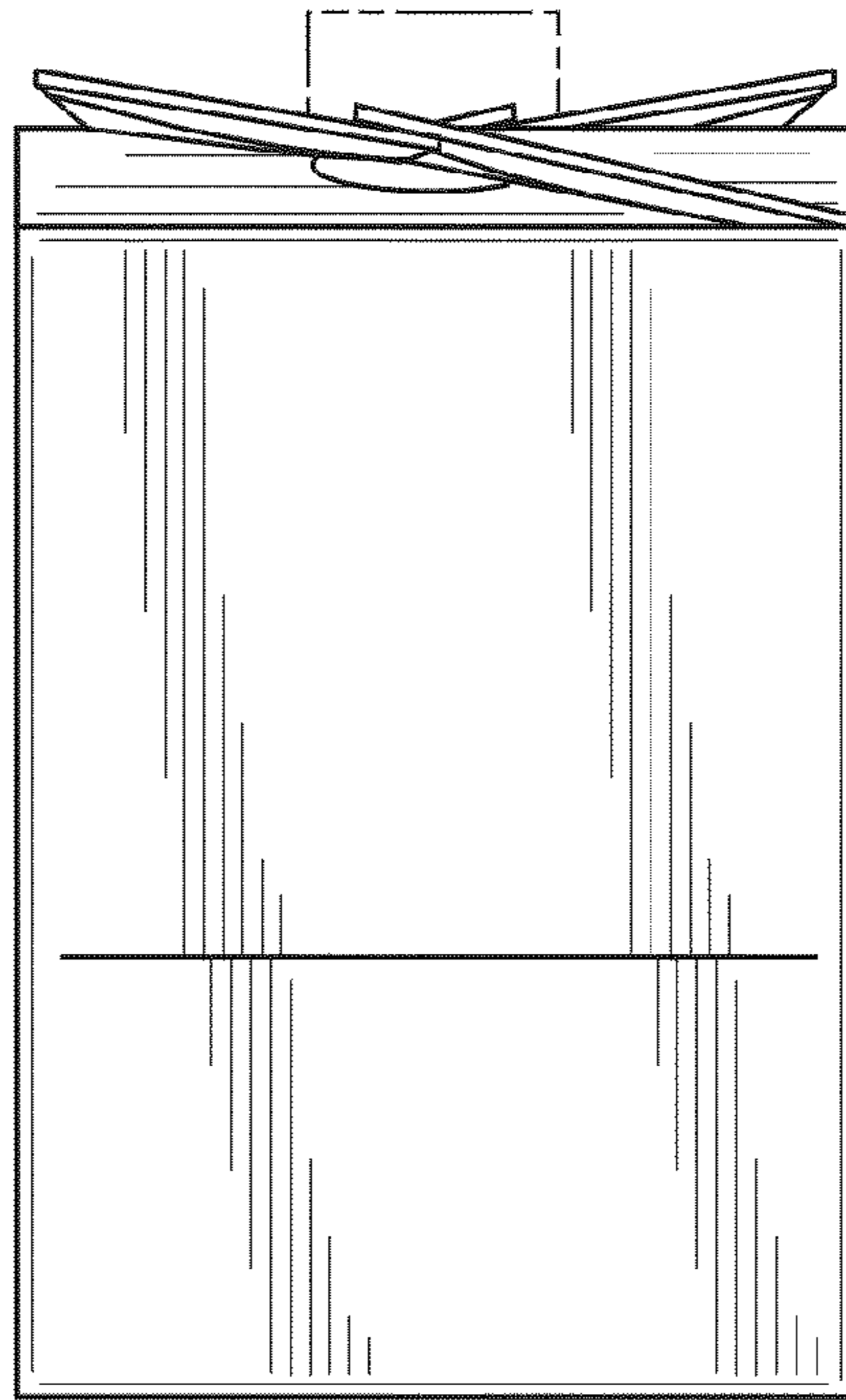

FIG. 2

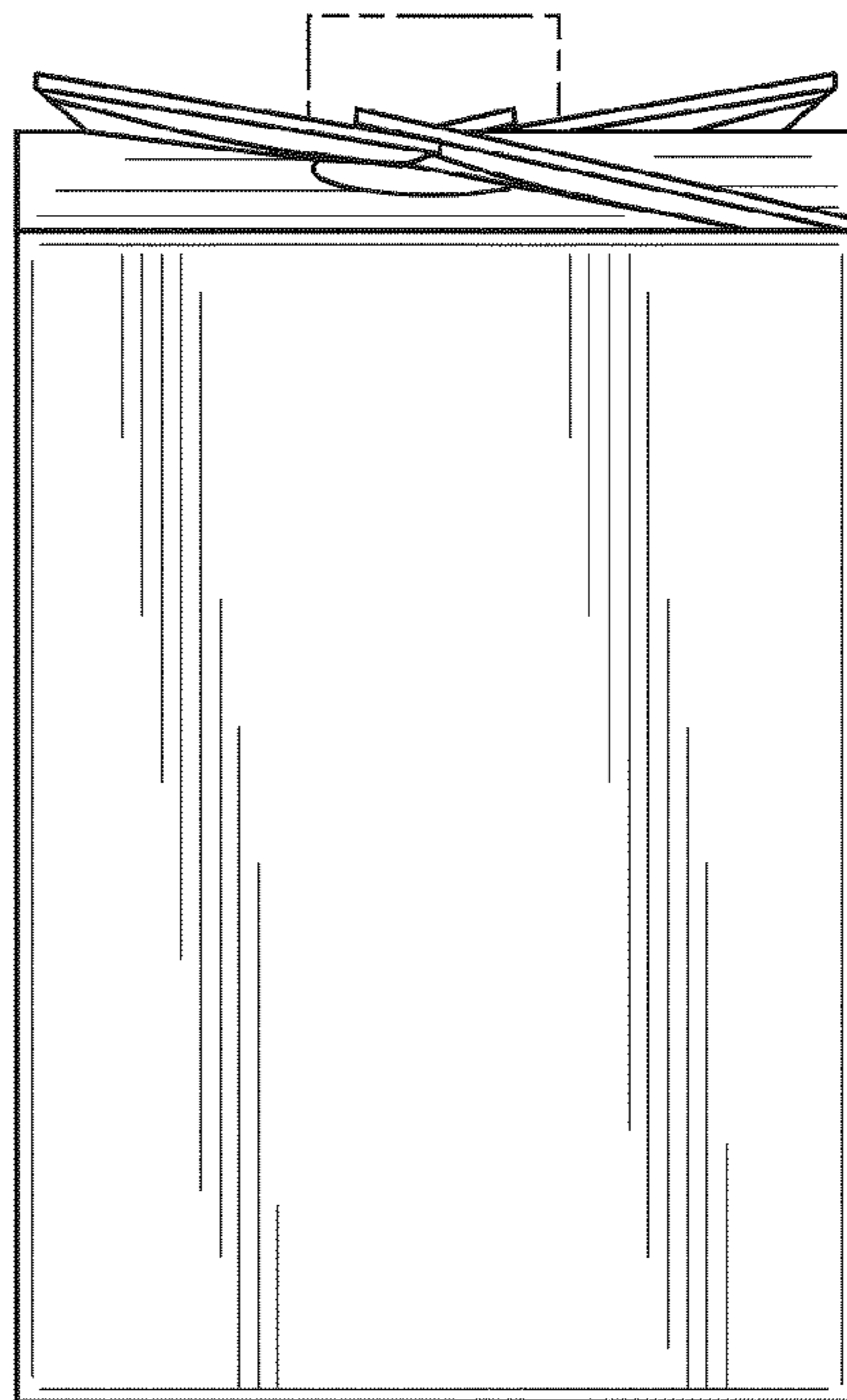

FIG. 3

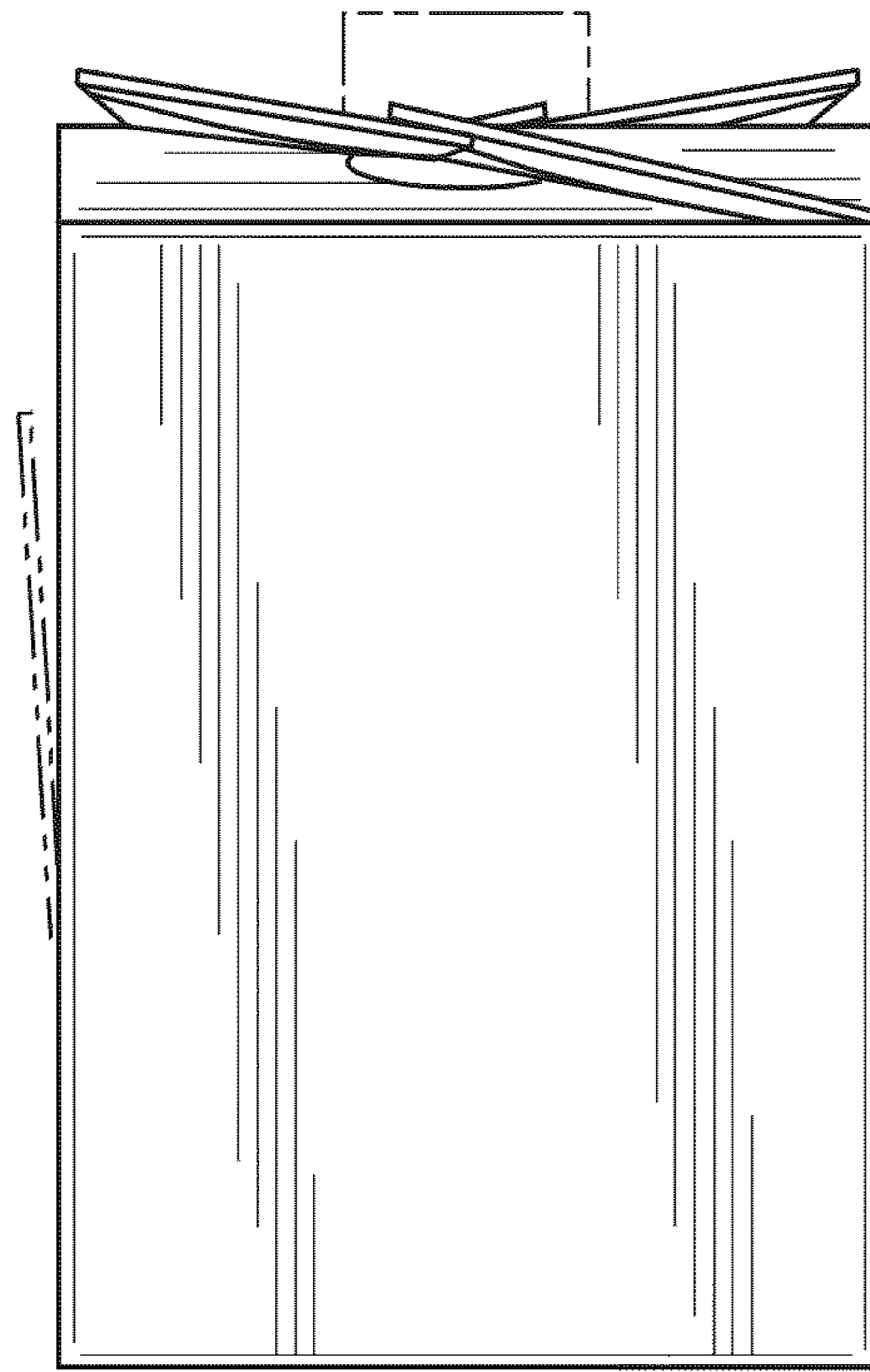

FIG. 4

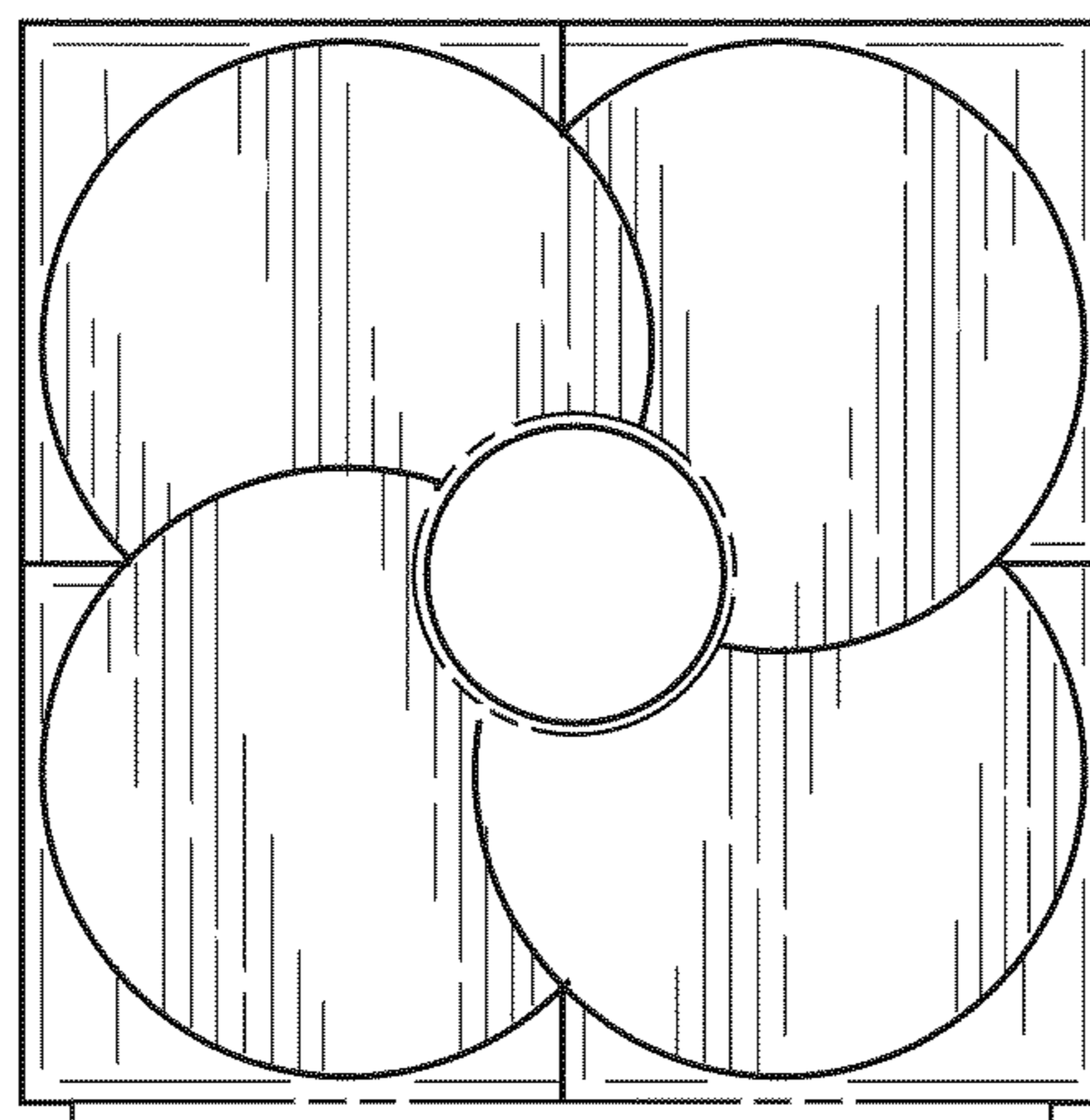

FIG. 5

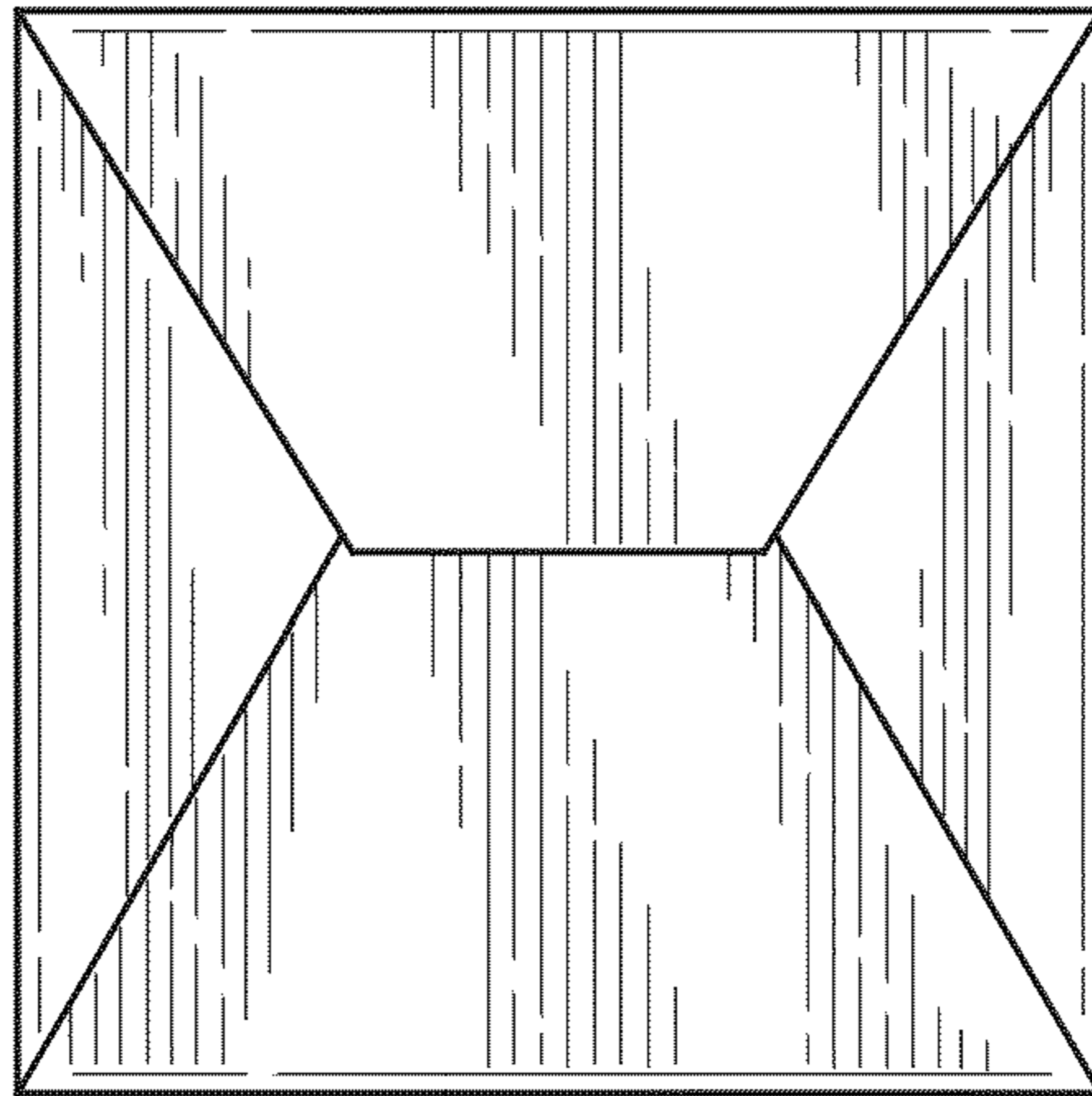

FIG. 6

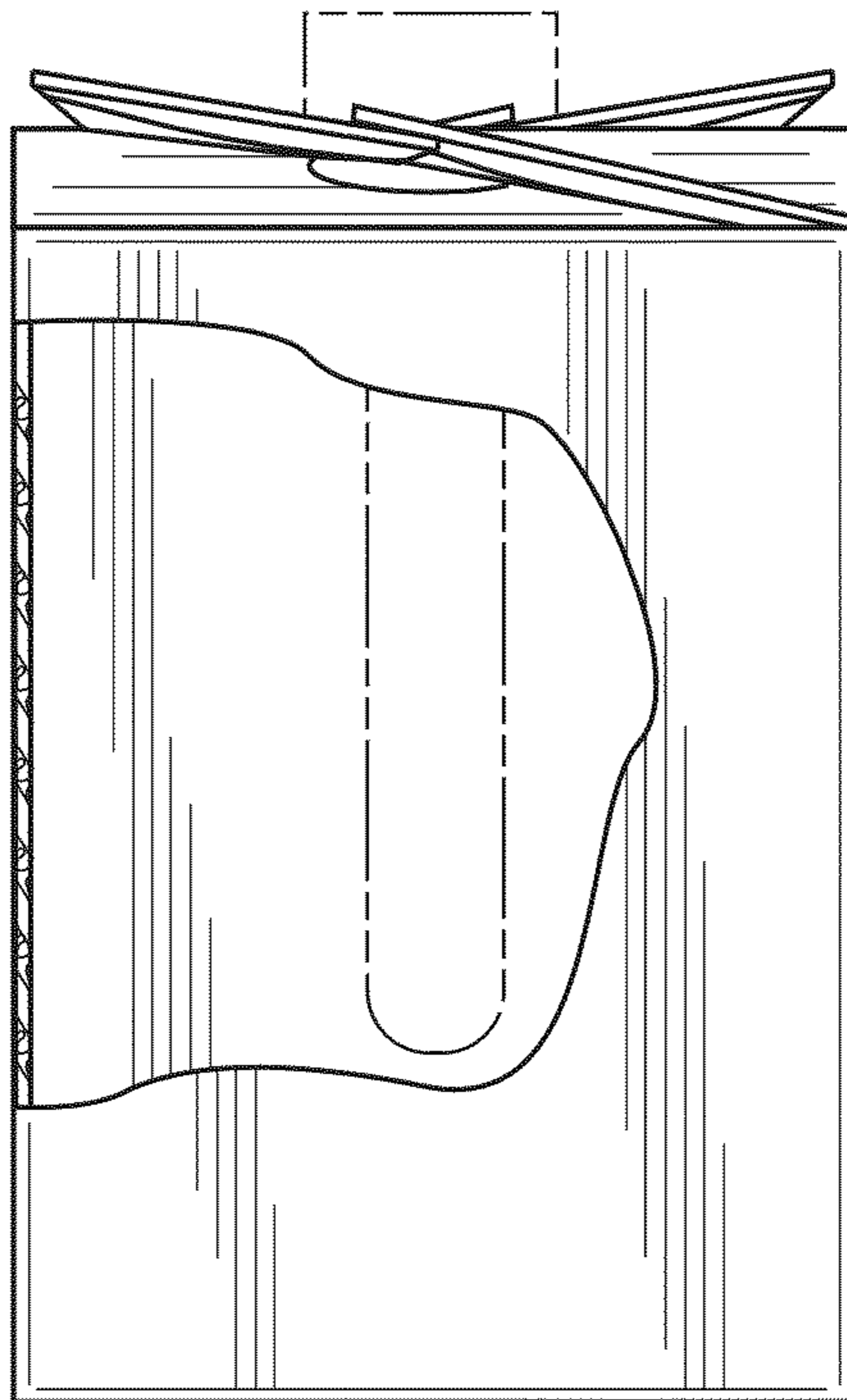

FIG. 7

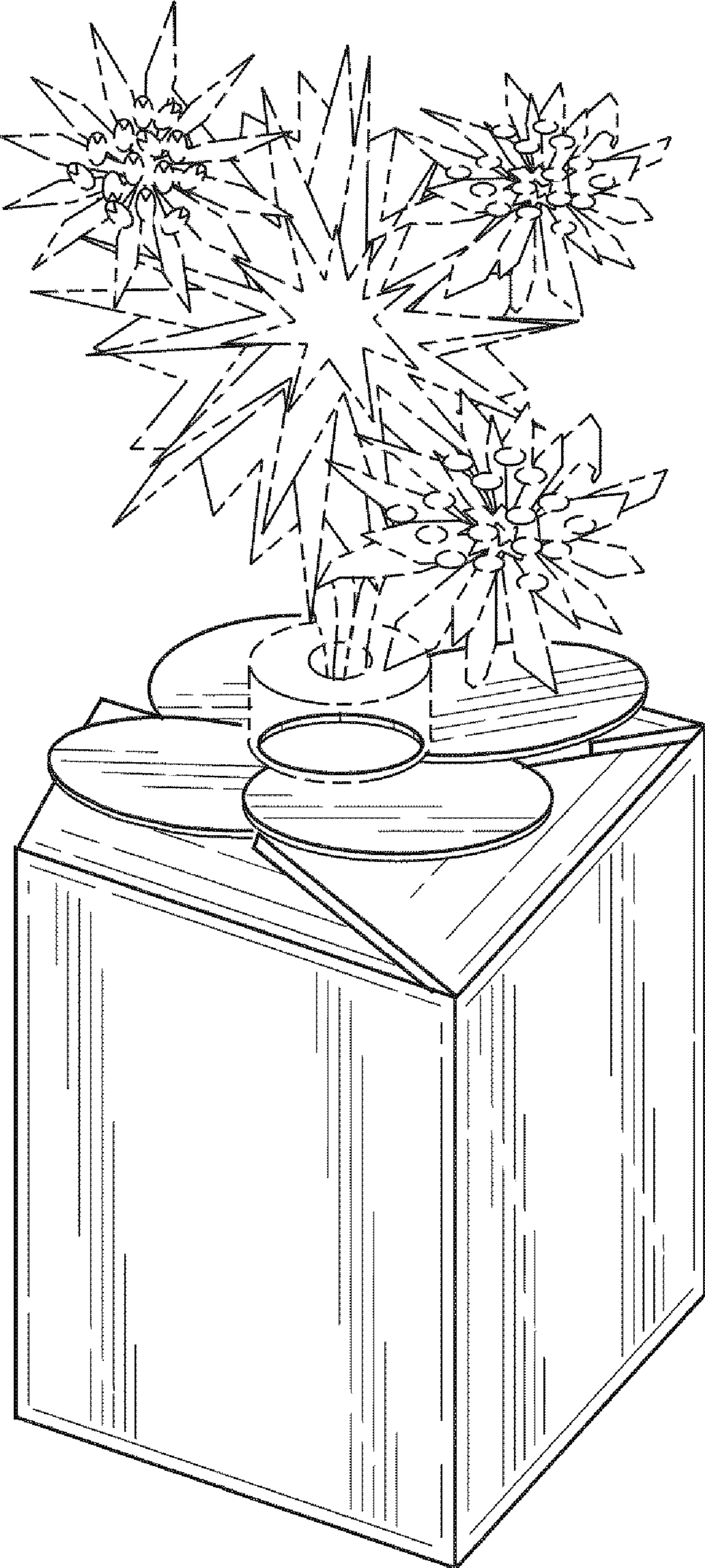

FIG. 8

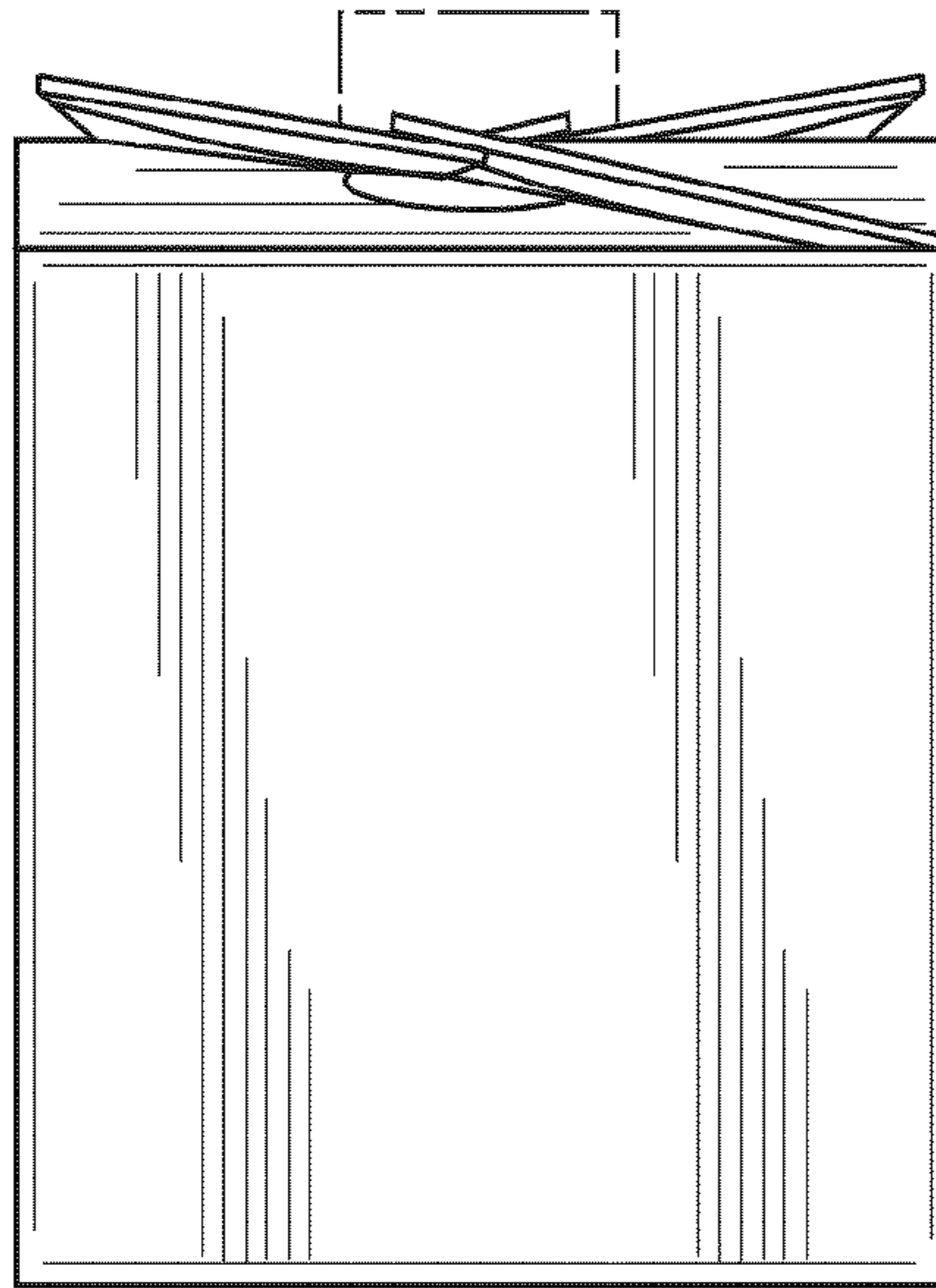

FIG. 9

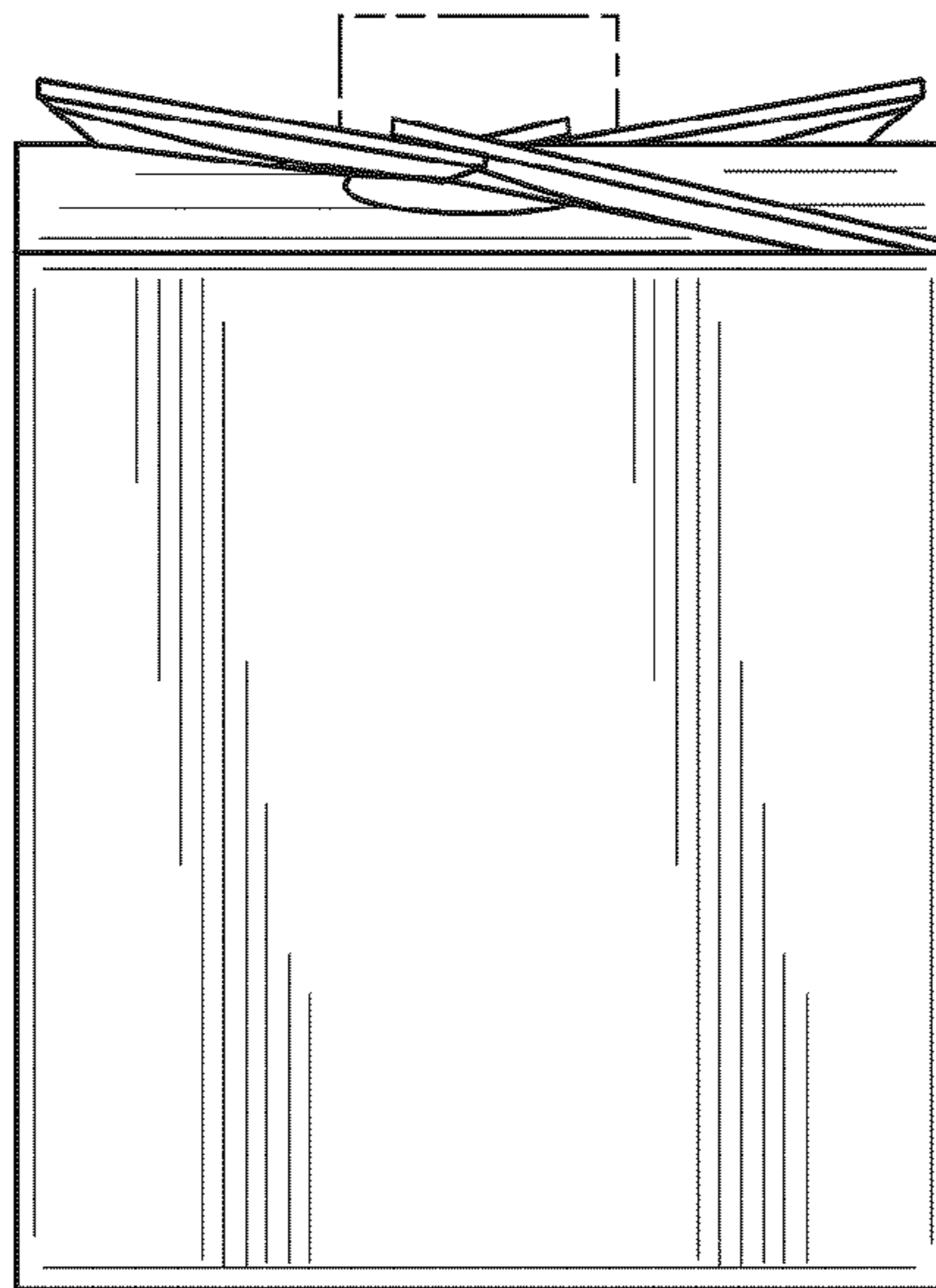

FIG. 10

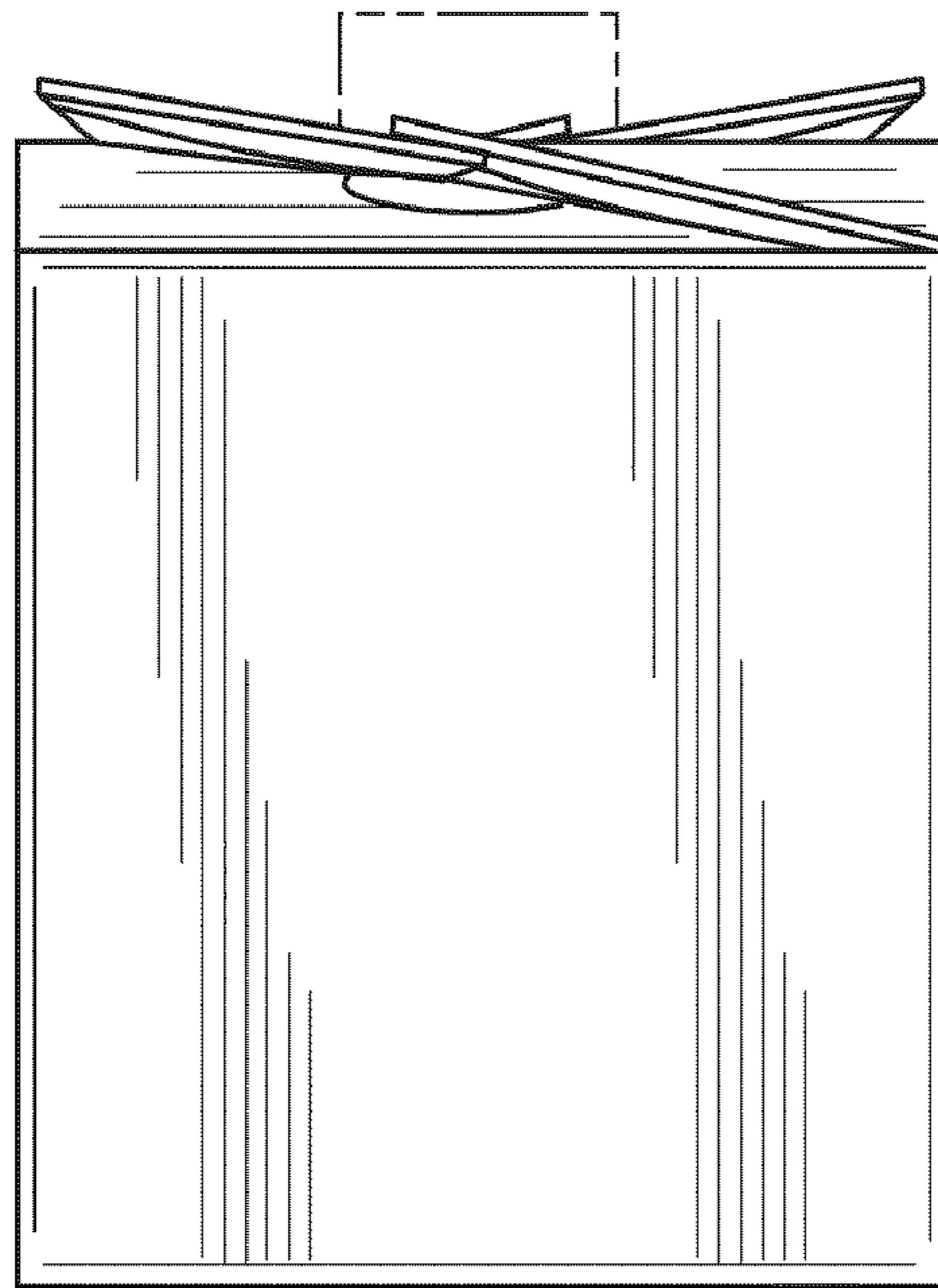

FIG. 11

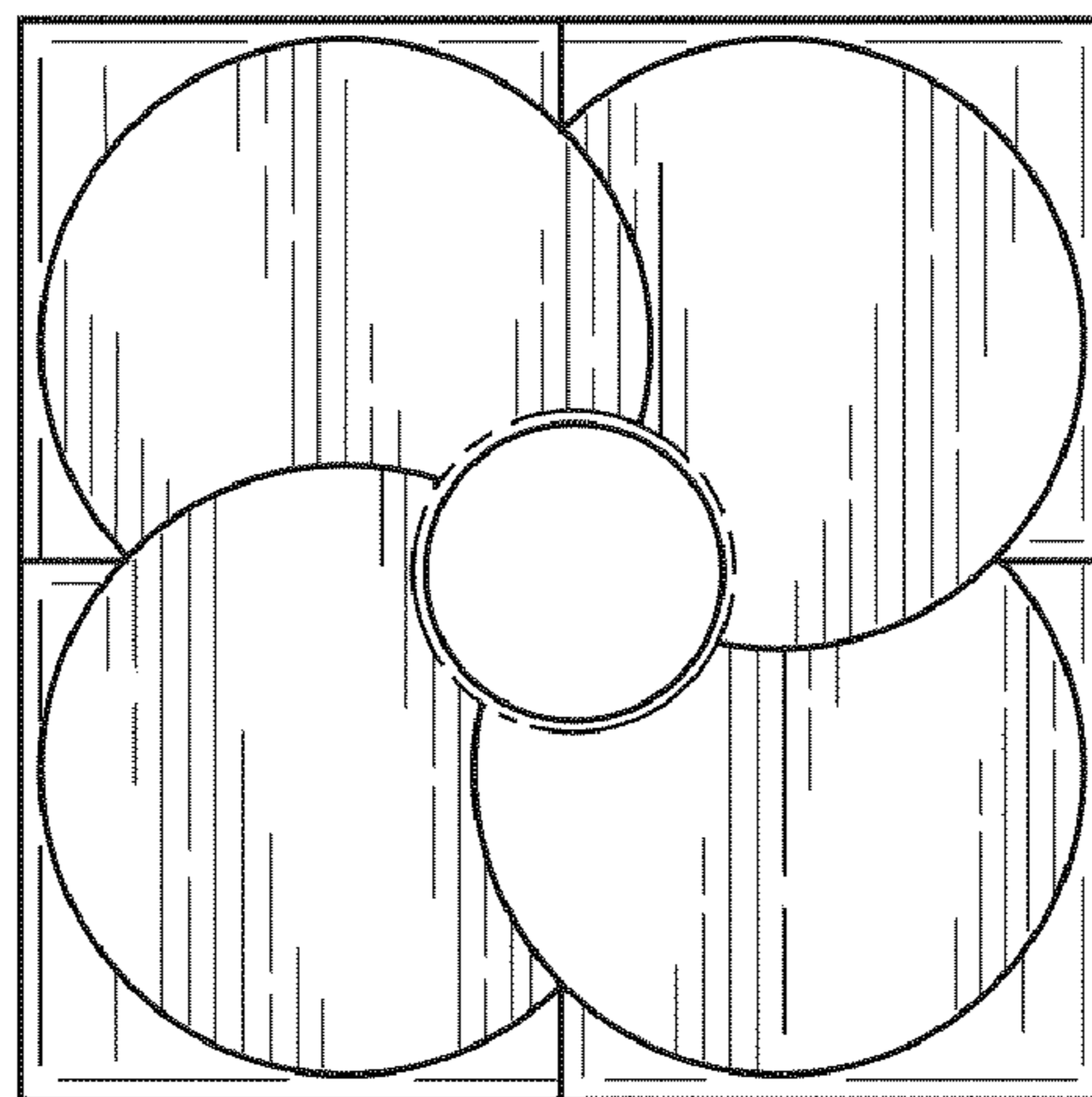

FIG. 12

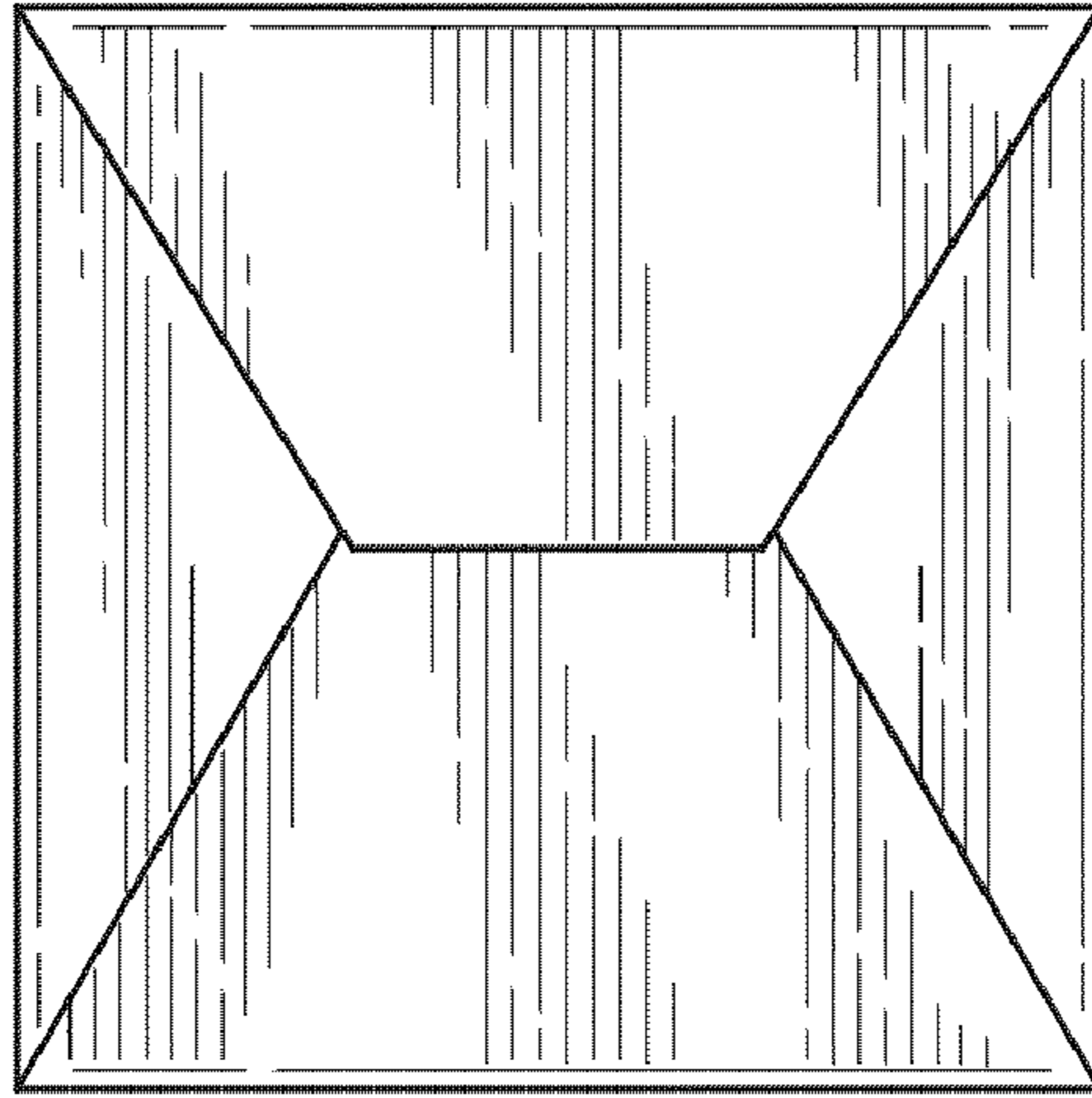

FIG. 13

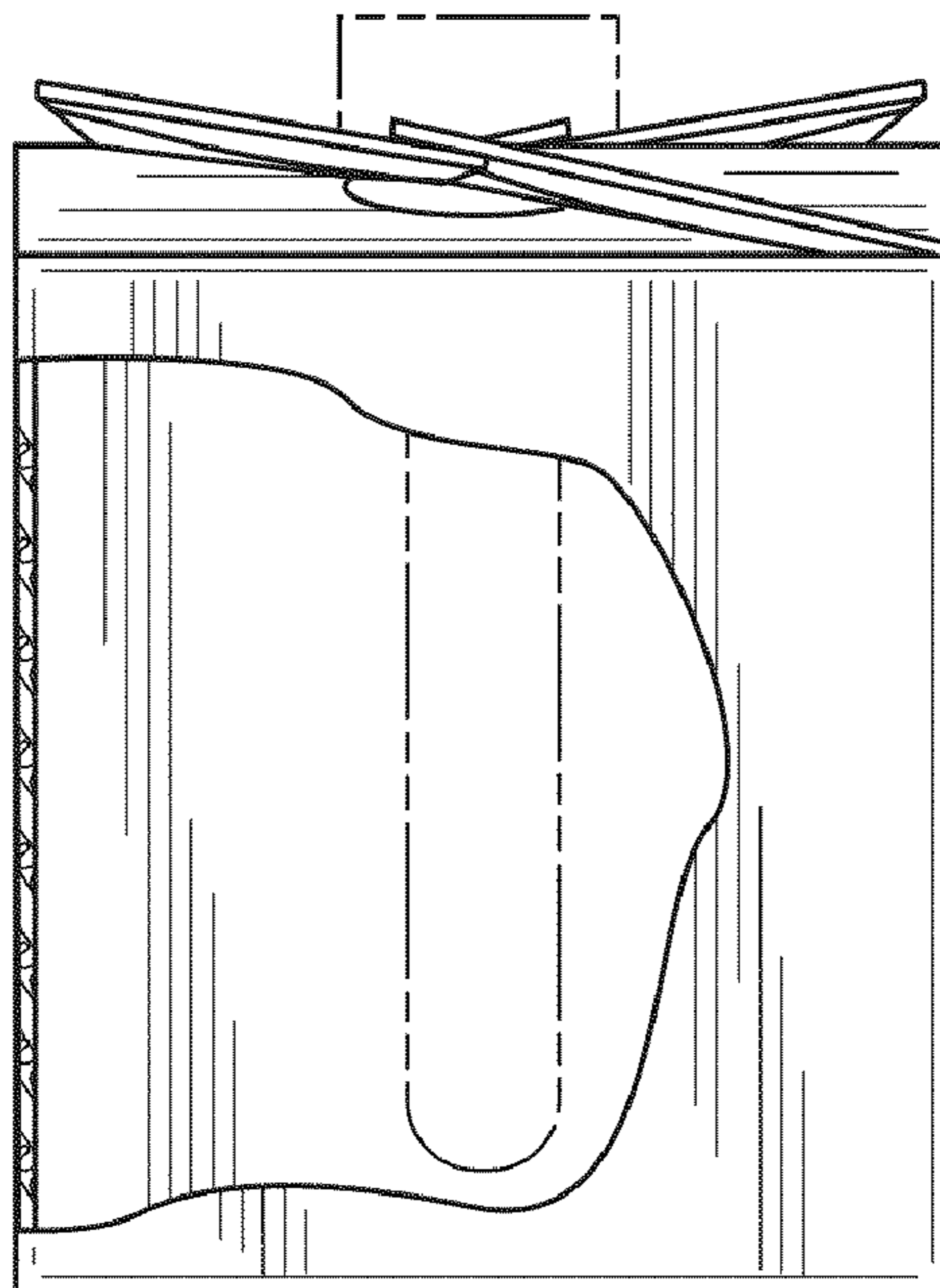

FIG. 14