



US00D635010S

(12) **United States Design Patent**
Bucci

(10) **Patent No.:** **US D635,010 S**
(45) **Date of Patent:** **** Mar. 29, 2011**

(54) **DEVICE FOR SUPPORTING AN OBJECT**

(76) Inventor: **Michael Bucci**, Glen Allen, VA (US)

(**) Term: **14 Years**

(21) Appl. No.: **29/360,742**

(22) Filed: **Apr. 30, 2010**

Related U.S. Application Data

(63) Continuation-in-part of application No. 29/355,157, filed on Feb. 3, 2010.

(51) **LOC (9) Cl.** **08-05**

(52) **U.S. Cl.** **D8/354; D21/505**

(58) **Field of Classification Search** D8/349, D8/354, 380, 382, 388, 400, 402, 499; D21/505, D21/803, 369, 373, 386, 388, 396; D10/109, D10/113; D20/10, 39-43; D1/105; 116/28 R, 116/63 R, 63 P, 63 T, 63 C, 209; 40/584, 40/606, 607, 608, 311, 312; 273/113, 153 P, 273/153 R, 153 S, 155, 157 R, 260; 446/69, 446/70, 121, 122, 125, 126; 248/346.01, 248/546, 694, 126, 176.1; 434/99, 102, 211, 434/403; 404/4-16; 405/21, 29; D30/106; D9/431, 432

See application file for complete search history.

(56) **References Cited**

U.S. PATENT DOCUMENTS

- 1,216,840 A 2/1917 Ramsey et al.
- 1,522,306 A 1/1925 Lewis
- 2,483,734 A 10/1944 Neal
- 2,800,099 A 7/1957 Baker
- 2,808,803 A 10/1957 Weig
- 2,843,971 A * 7/1958 Gardellin 446/126
- D206,635 S 1/1967 Walter
- 3,565,442 A 2/1971 Klein
- 3,608,906 A 9/1971 Odler
- 3,659,360 A 5/1972 Zeischegg
- 3,666,607 A 5/1972 Weissman
- 3,779,554 A 12/1973 Brix
- 3,782,029 A 1/1974 Bardot

- 3,800,735 A 4/1974 Simpson
- D231,787 S 6/1974 Burnley
- 3,840,234 A * 10/1974 Felsten 273/113
- 3,940,100 A 2/1976 Haug

(Continued)

Primary Examiner — Cynthia M Chin

(74) *Attorney, Agent, or Firm* — Brian J. Teague

(57) **CLAIM**

I claim the ornamental design for a device for supporting an object, as shown and described.

DESCRIPTION

This application claims priority to U.S. Design Pat. No. D613,582, filed Dec. 22, 2009 and issued Apr. 13, 2010, and to U.S. Design Pat. No. D609,077, filed Sep. 17, 2009 and issued Feb. 2, 2010, which are divisionals of and claim priority to U.S. Design Pat. No. D603,245, filed Mar. 20, 2009 and issued Nov. 3, 2009; which in turn is a continuation-in-part of and claims priority to U.S. Design Pat. No. D602,341, filed Oct. 20, 2008 and issued Oct. 20, 2009; which in turn is a continuation-in-part of and claims priority to U.S. Design Pat. No. D581,251, filed Aug. 14, 2007 and issued Nov. 25, 2008, and U.S. Design Pat. No. D581,254, filed Sep. 20, 2007 and issued Nov. 25, 2008; the contents of which are incorporated herein by reference in their entirety.

FIG. 1 is a perspective view of one embodiment of a device for supporting an object showing the new design; FIG. 2 is a front elevational view thereof; FIG. 3 is a rear elevational view thereof; FIG. 4 is a top view thereof; FIG. 5 is a bottom view thereof; FIG. 6 is a perspective view of an alternative embodiment of a device for supporting an object; FIG. 7 is a front elevational view thereof; FIG. 8 is a rear elevational view thereof; FIG. 9 is a left side elevational view thereof; FIG. 10 is a right side elevational view thereof; FIG. 11 is a top view thereof; and, FIG. 12 is a bottom view thereof.

1 Claim, 7 Drawing Sheets

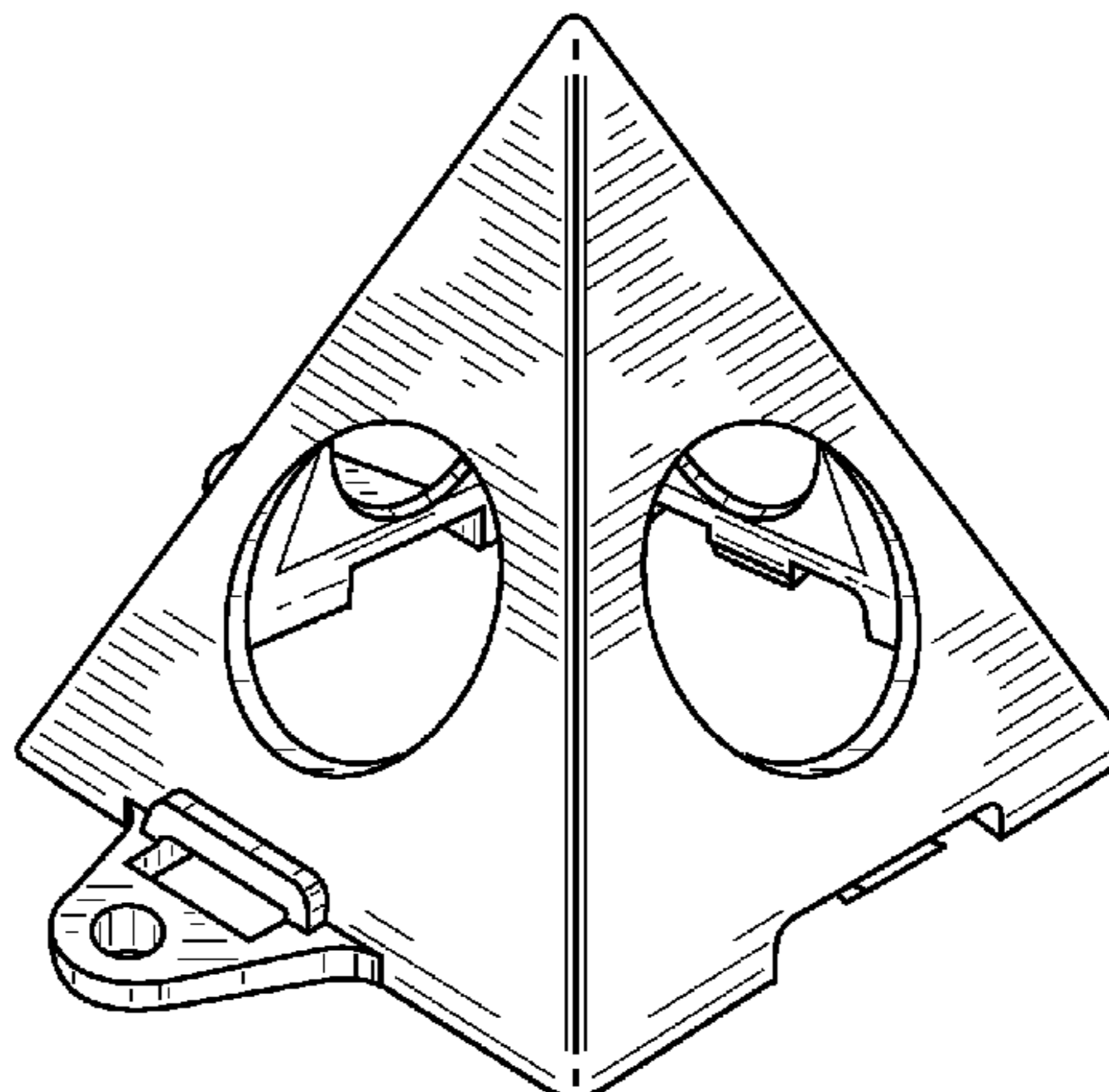
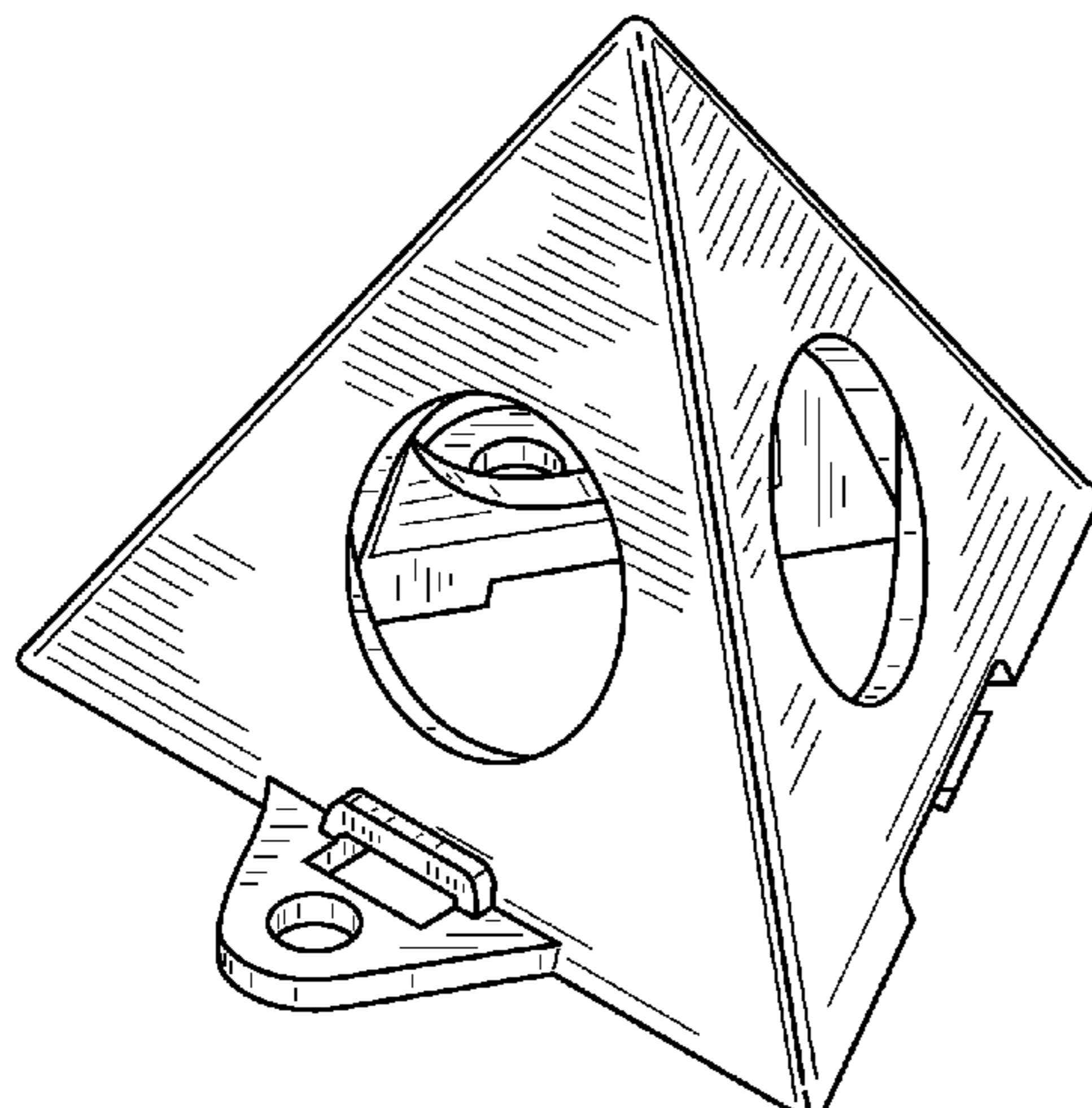

US D635,010 S

Page 2

U.S. PATENT DOCUMENTS

3,974,611 A	8/1976	Satterthwaite			
D242,640 S	12/1976	Mosher			
4,026,087 A	5/1977	White			
D245,279 S	8/1977	Hollendonner			
4,063,725 A *	12/1977	Snyder	273/155		
D250,174 S	11/1978	Hedgecock			
D250,687 S	1/1979	Robelen			
4,159,112 A	6/1979	O'Brian et al.			
D261,373 S	10/1981	Fisher			
D262,901 S	2/1982	Vukadinovic			
D263,255 S	3/1982	Zima			
4,317,654 A	3/1982	Wahl			
4,323,245 A	4/1982	Beaman			
4,345,761 A	8/1982	China			
4,354,288 A	10/1982	Dennis			
D267,588 S	1/1983	Goodell			
D268,315 S	3/1983	Kirk			
D272,841 S	2/1984	Matsumoto			
D273,095 S	3/1984	Schulze			
4,461,480 A	7/1984	Mitchell			
D275,889 S	10/1984	Nelson			
4,558,866 A	12/1985	Alford			
4,761,137 A	8/1988	Taylor et al.			
4,848,263 A	7/1989	Grimm			
D305,343 S	1/1990	Epperson et al.			
4,934,701 A	6/1990	Ting			
D314,018 S	1/1991	Rosenthal			
D315,186 S	3/1991	Peterson			
D315,773 S	3/1991	Peterson			
D325,168 S	4/1992	Dlabac			
D325,615 S	4/1992	Matsch			
5,184,822 A *	2/1993	Bognar et al.	273/153 R		
5,199,375 A	4/1993	Johson			
5,259,695 A *	11/1993	Mostkoff	405/29		
5,297,012 A	3/1994	Fletcher			
D351,623 S	10/1994	Seiler			
5,354,224 A	10/1994	Ishiyama			
5,375,845 A	12/1994	Cooter et al.			
5,400,998 A	3/1995	Ma			
5,407,201 A	4/1995	Whitehurst			
D367,119 S	2/1996	Trunk			
D367,384 S	2/1996	DiFranco et al.			
D373,528 S *	9/1996	Ser Tuen Wei	D9/431		
5,601,645 A	2/1997	Nonomura et al.			
5,615,429 A	4/1997	Williams			
D389,550 S	1/1998	Williams			
5,769,598 A	6/1998	MacNeil			
5,788,933 A	8/1998	Peddicord			
D403,981 S	1/1999	Dillard			
5,895,304 A	4/1999	Dixon			
D409,687 S	5/1999	Mak			
5,945,161 A	8/1999	Hashimoto et al.			
5,947,786 A	9/1999	Glick			
D417,314 S *	11/1999	Smith, Jr.	D30/106		
D417,329 S	11/1999	Ramadei			
D423,342 S *	4/2000	Popesco	D21/505		
6,224,453 B1 *	5/2001	McKinley et al.	446/69		
D443,900 S *	6/2001	Eklund	D21/369		
6,247,424 B1	6/2001	Huang			
D445,721 S	7/2001	McLeish et al.			
6,425,646 B1	7/2002	Andrews			
D478,194 S	8/2003	McGinty			
D482,111 S	11/2003	Laferriere et al.			
D483,200 S	12/2003	Udommahuntisuk			
D493,198 S	7/2004	Starkel			
6,976,768 B2	12/2005	Hewson			
D514,463 S	2/2006	Levine			
D514,971 S	2/2006	Burch et al.			
D515,683 S	2/2006	LaBlaine			
7,047,681 B2	5/2006	Perelli et al.			
D522,348 S	6/2006	Hansen			
D529,377 S	10/2006	Heiss			
D551,116 S	9/2007	Devory, Jr.			
D562,915 S	2/2008	Davis			
D569,076 S	5/2008	Lebrand			
D574,293 S	8/2008	Devory, Jr.			
D574,440 S	8/2008	Goodrich			
D579,369 S	10/2008	Spataro			
D597,432 S	8/2009	Auberger			
2004/0159280 A1	8/2004	Mohelsky et al.			
2005/0014112 A1	1/2005	Fentress			
2006/0157544 A1	7/2006	Chomic, Jr. et al.			

* cited by examiner

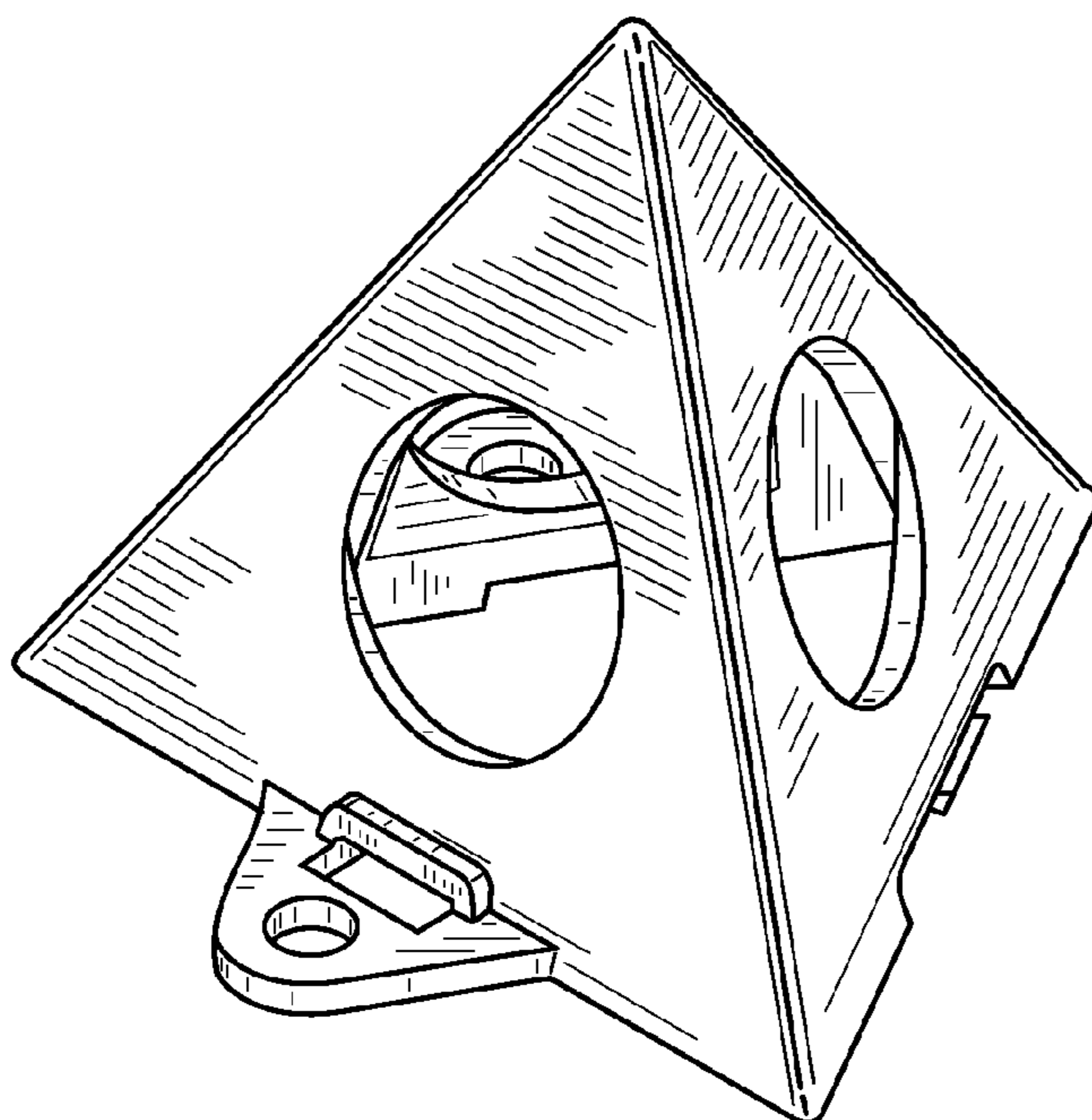

FIG. 1

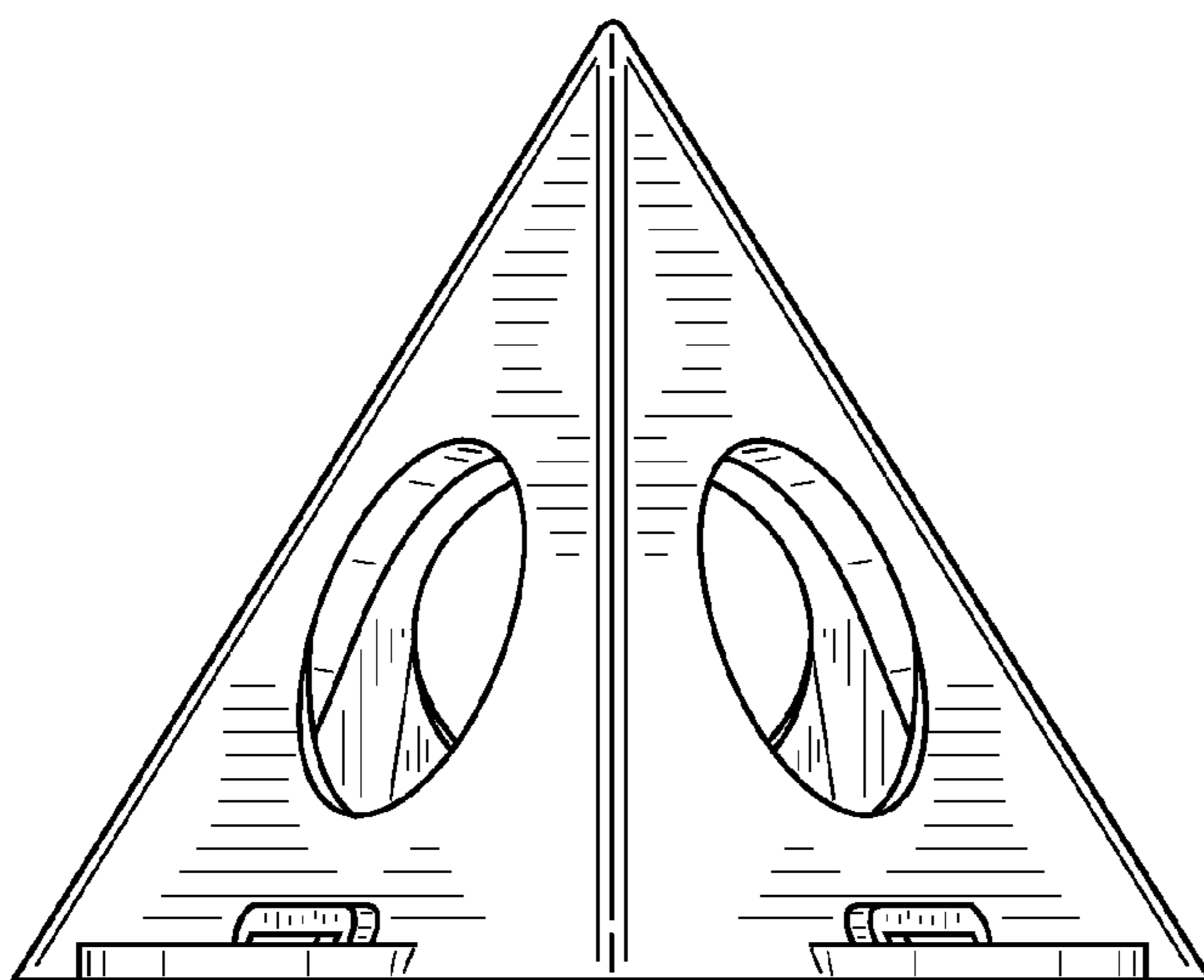

FIG. 2

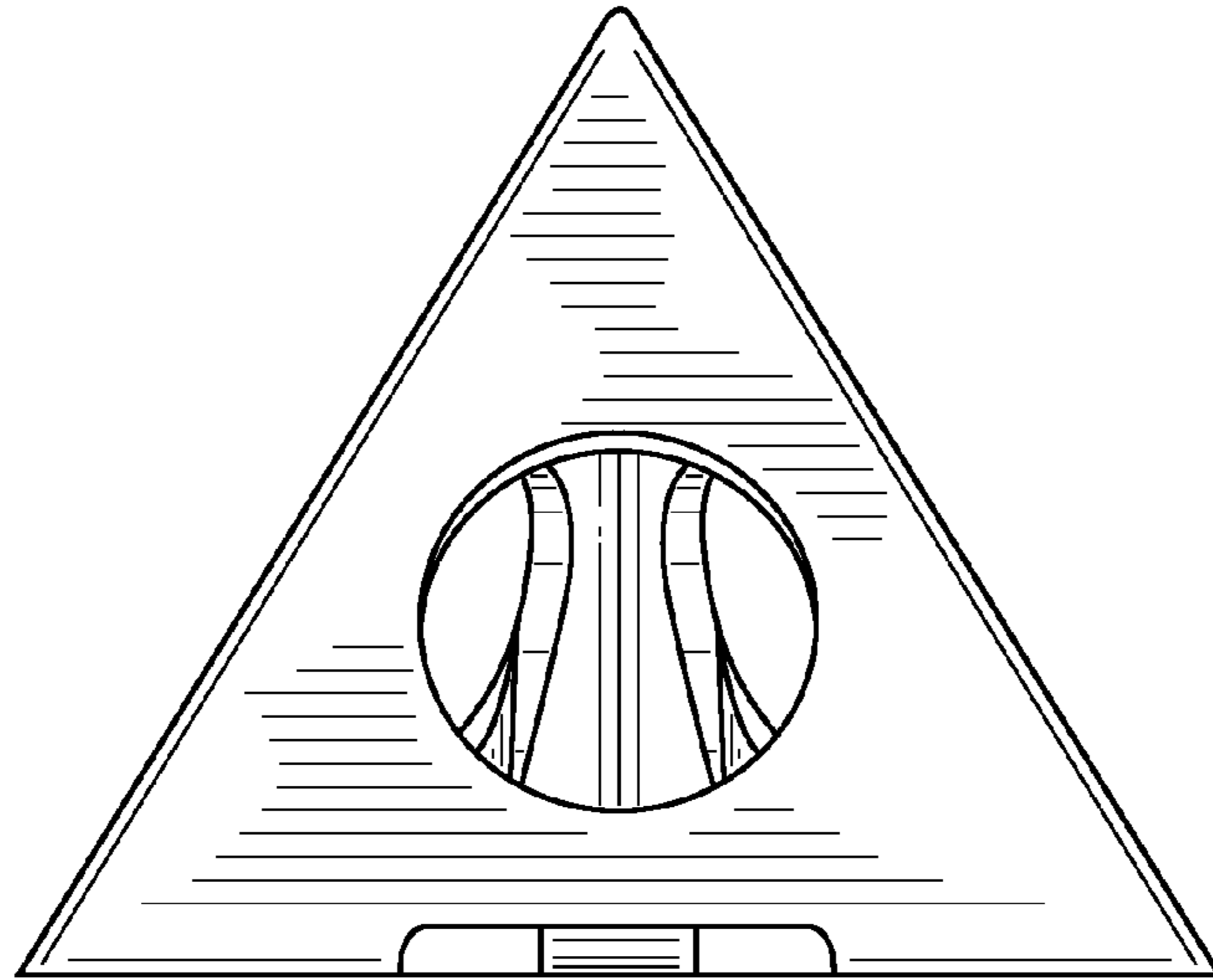

FIG. 3

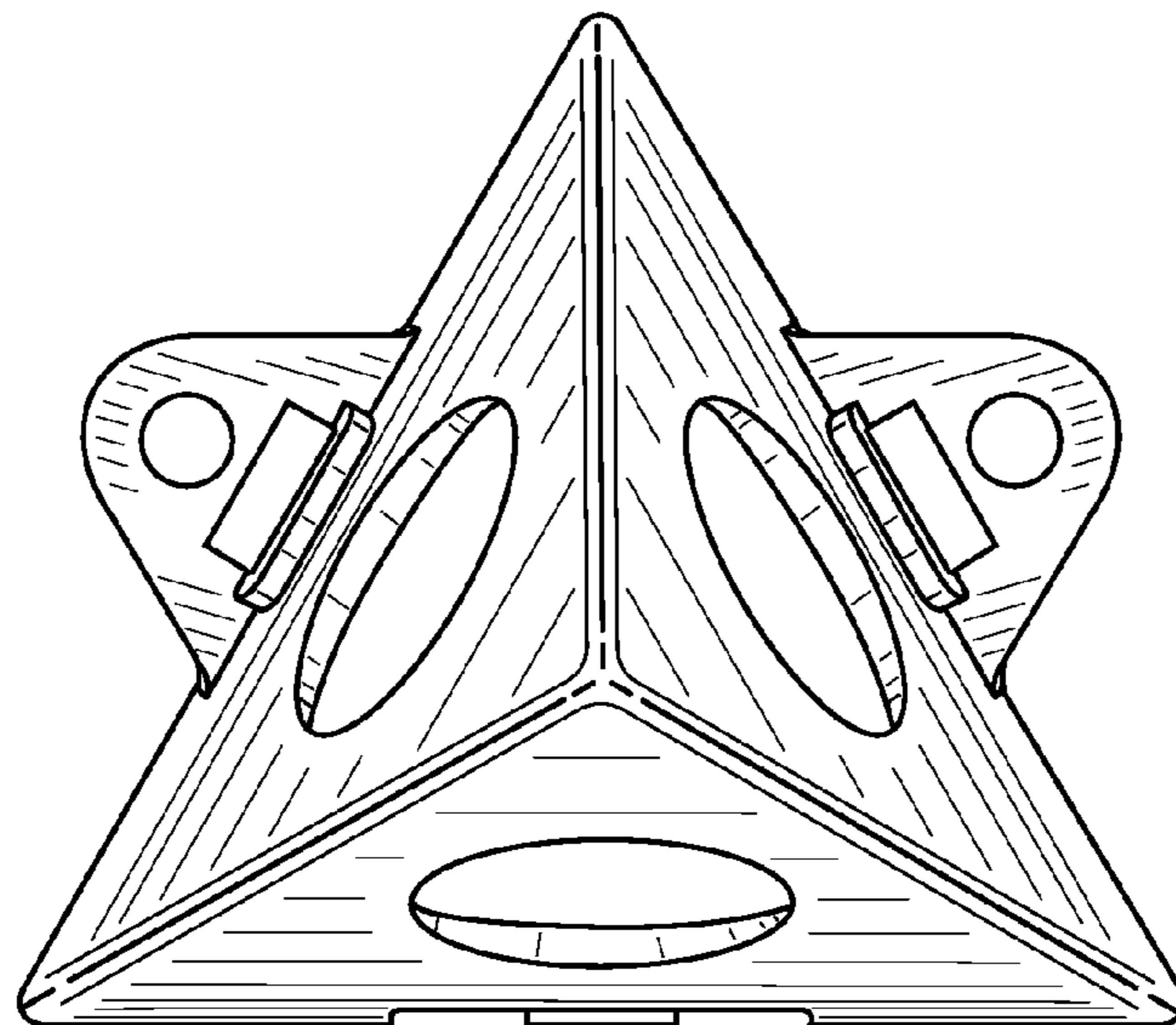

FIG. 4

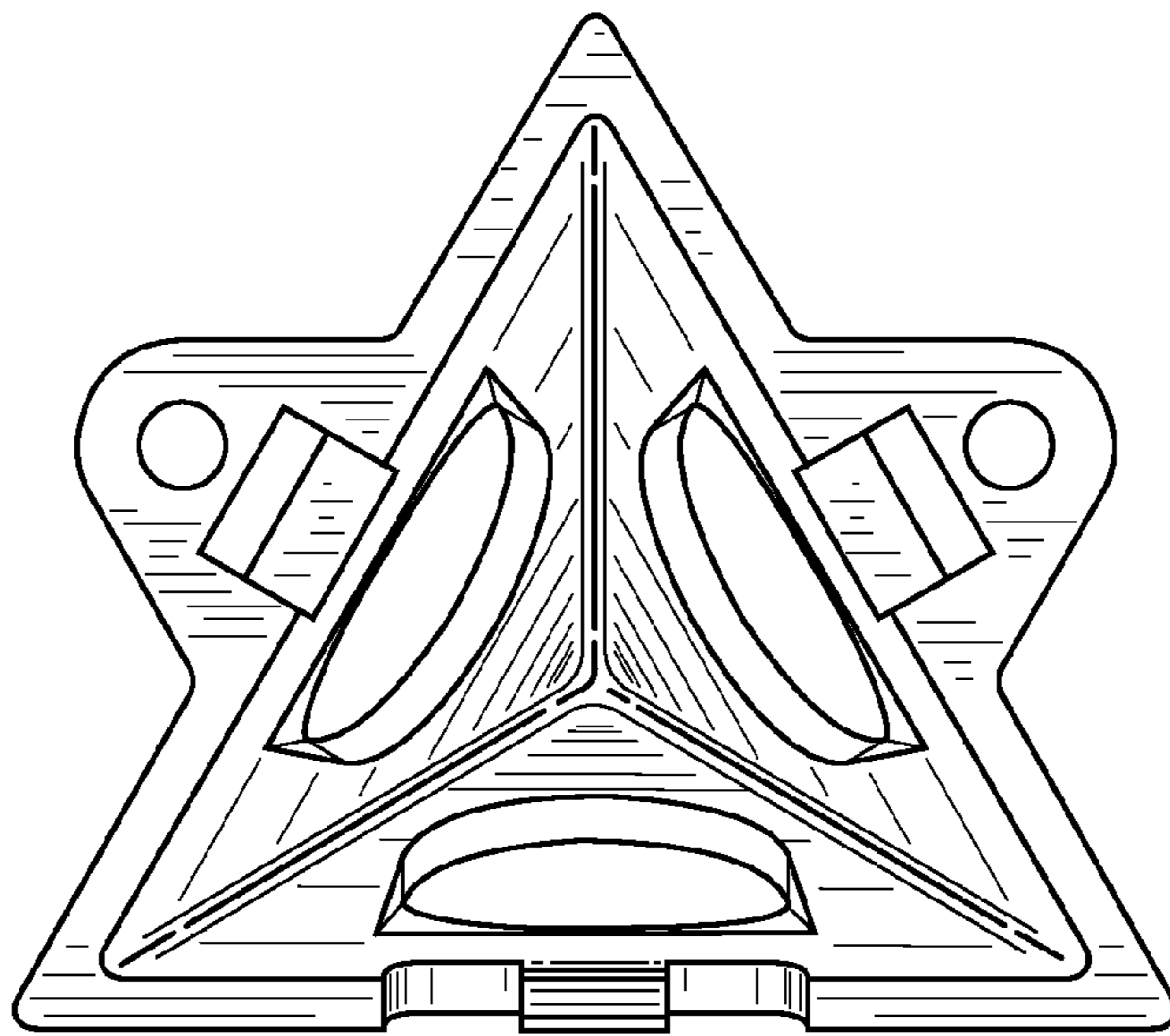

FIG. 5

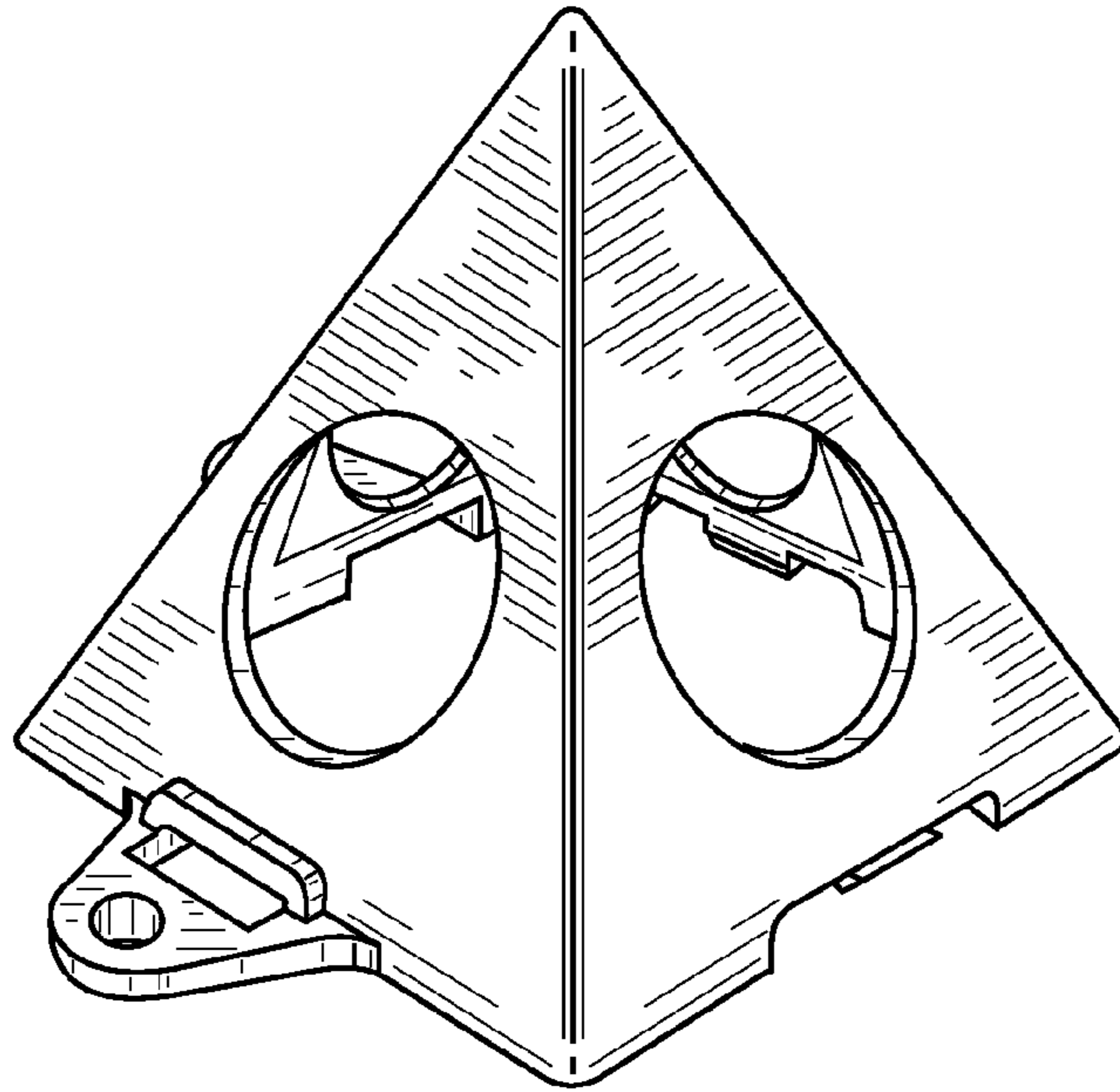

FIG. 6

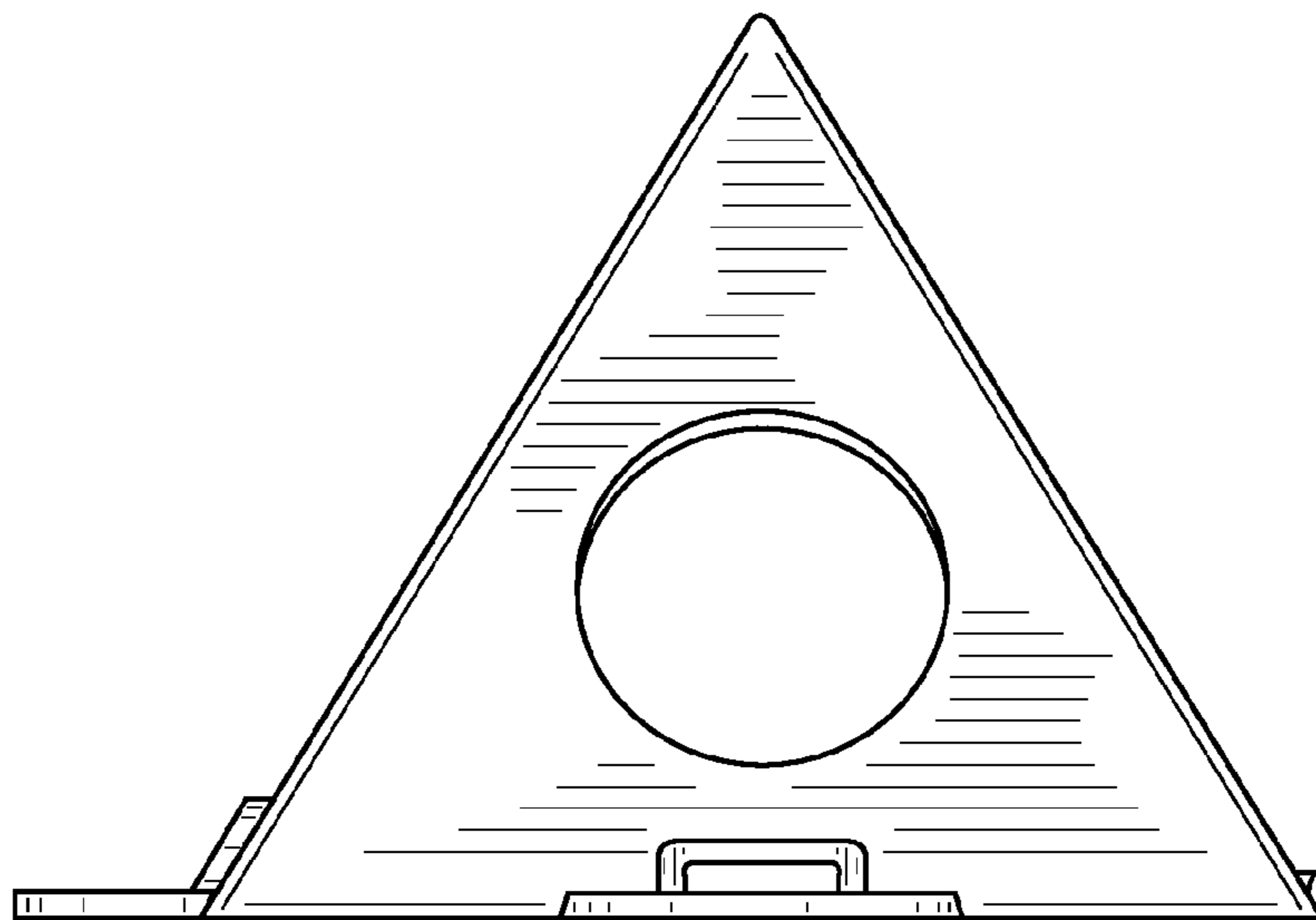

FIG. 7

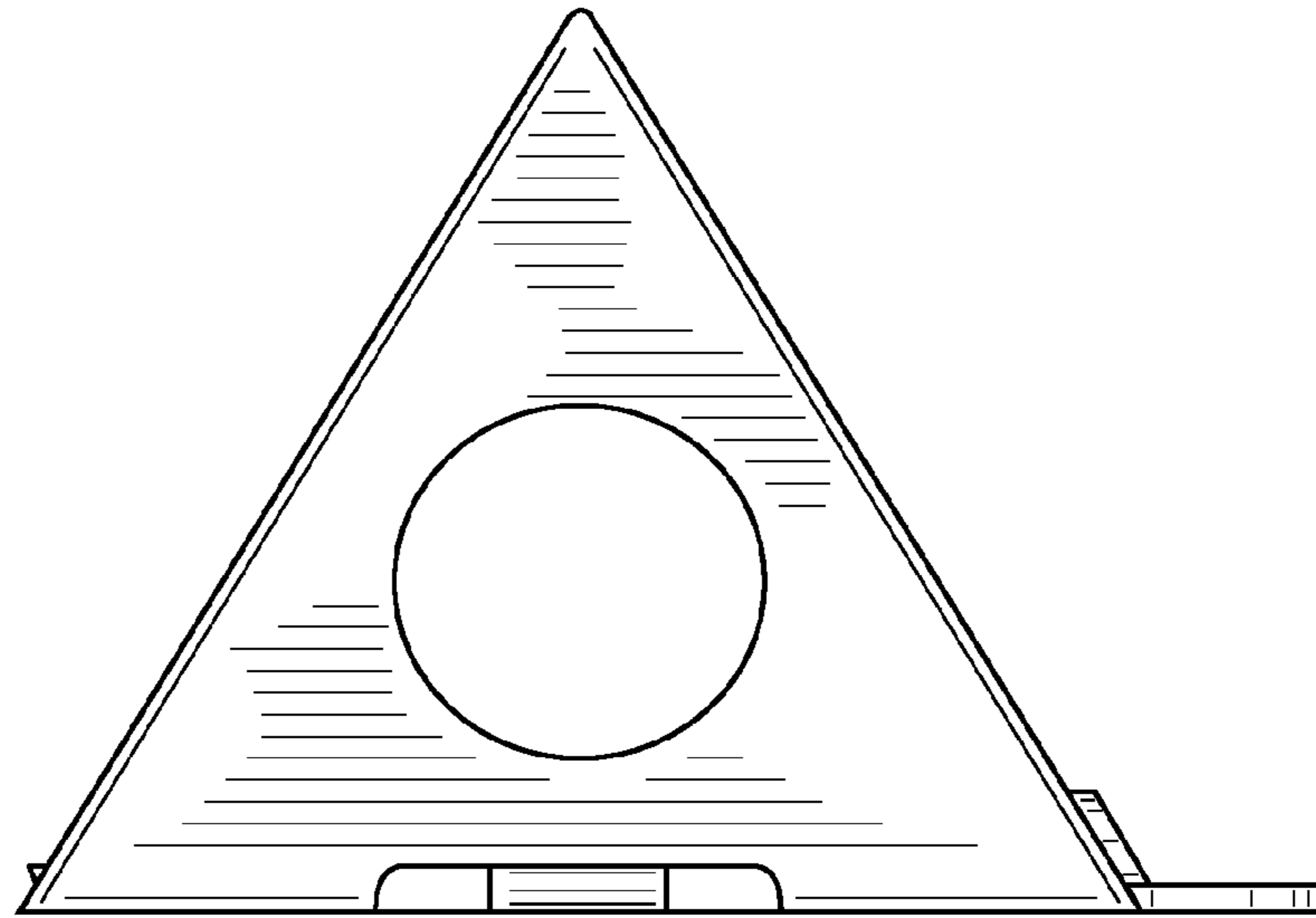

FIG. 8

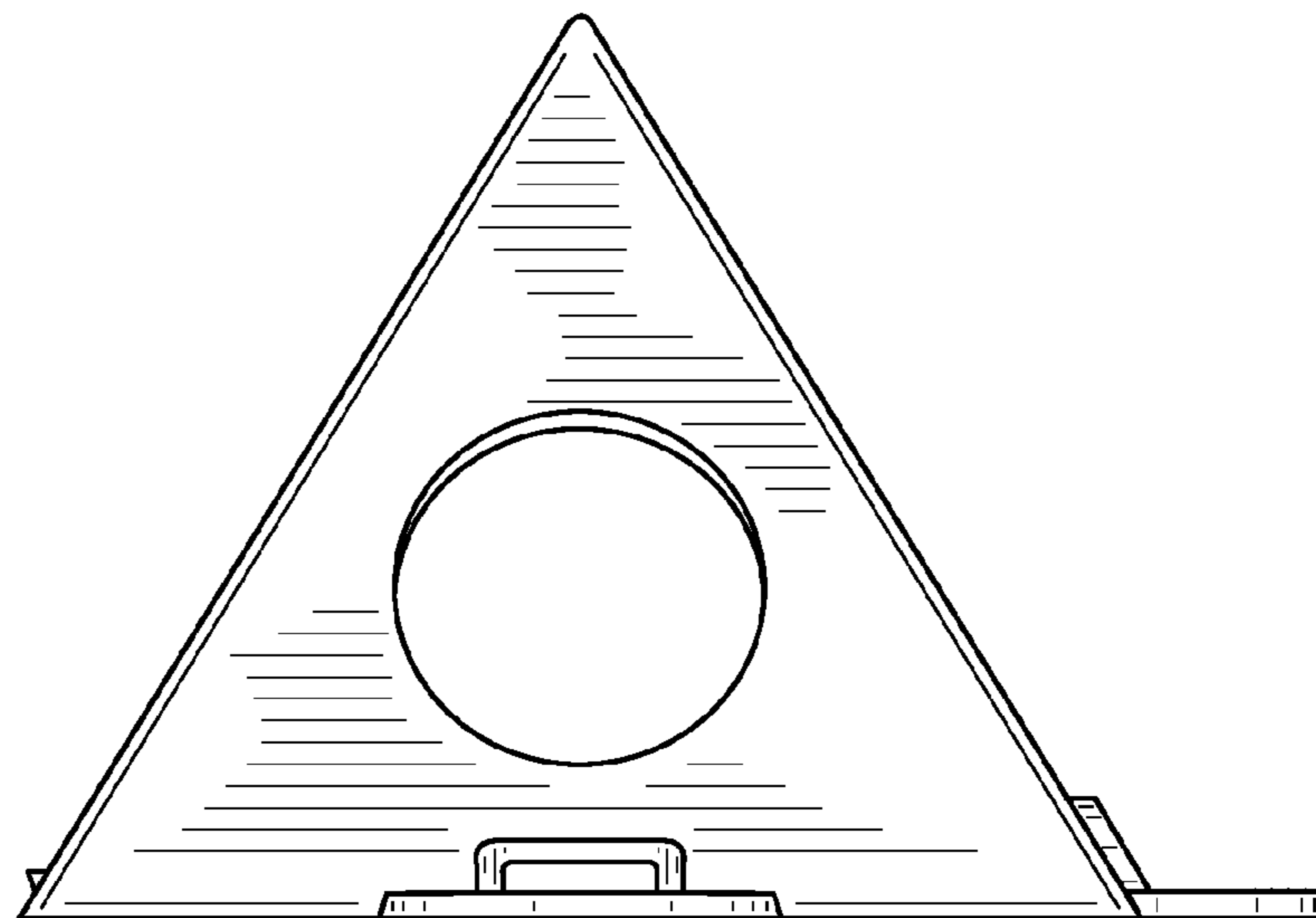

FIG. 9

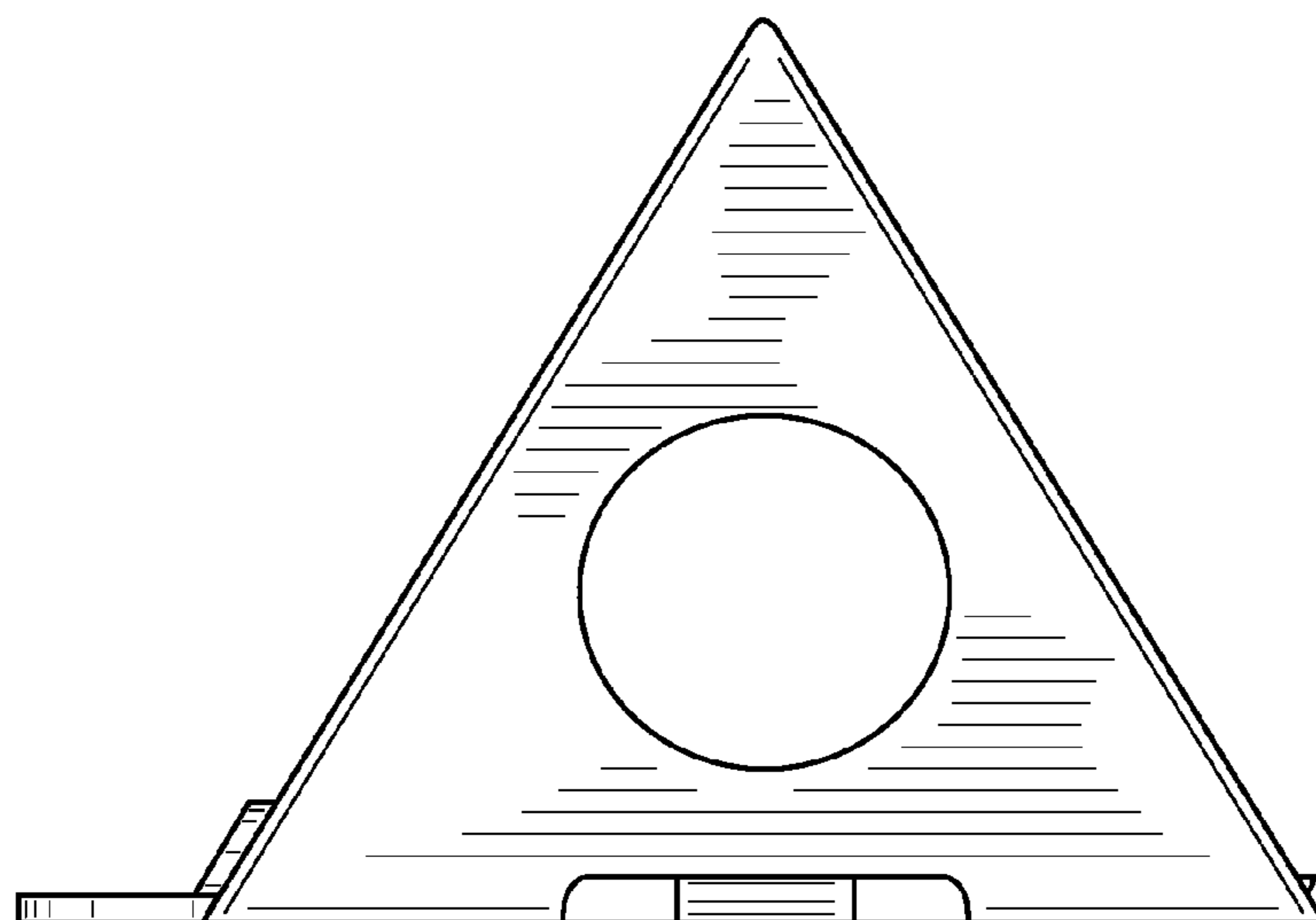

FIG. 10

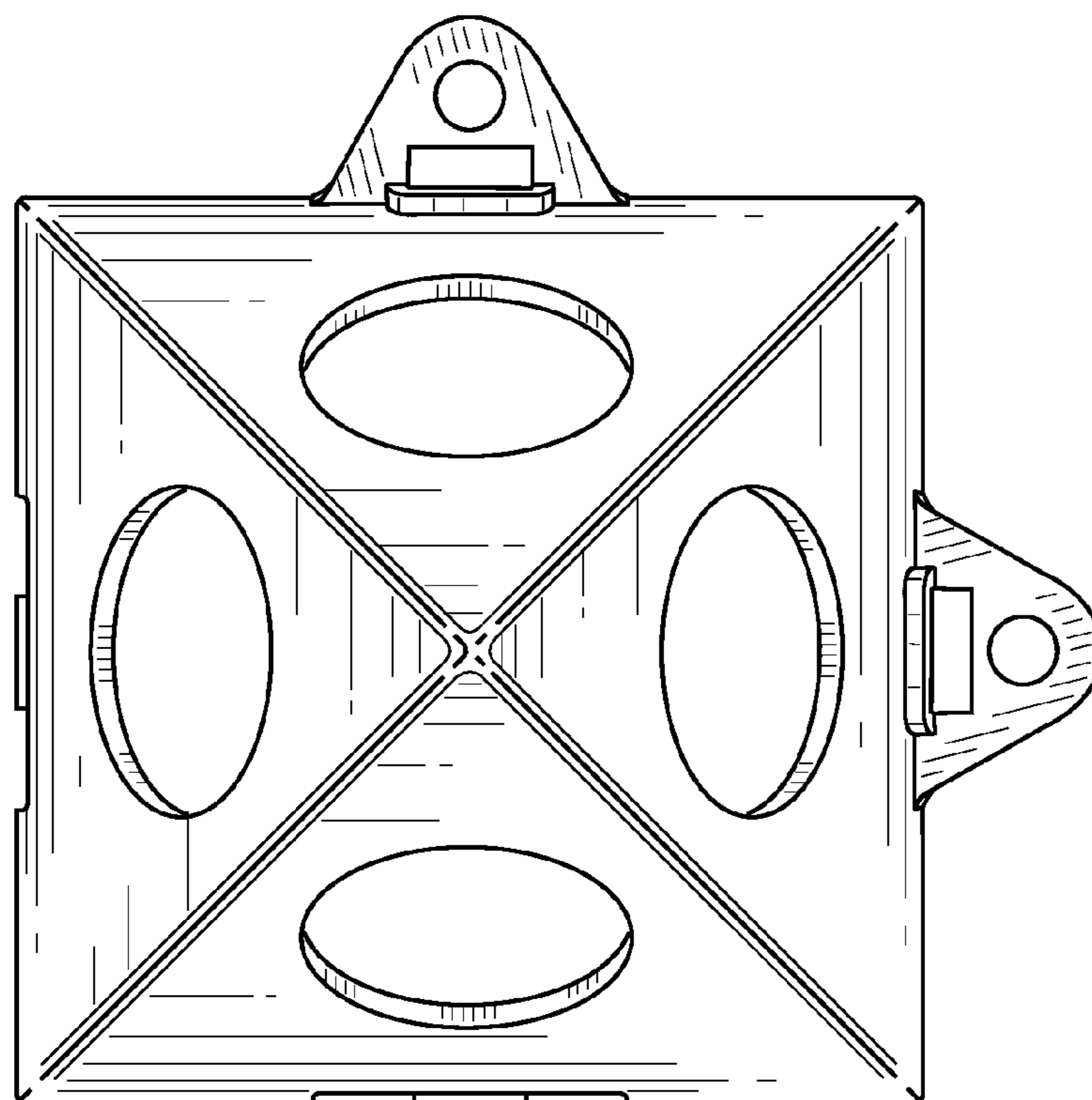

FIG. 11

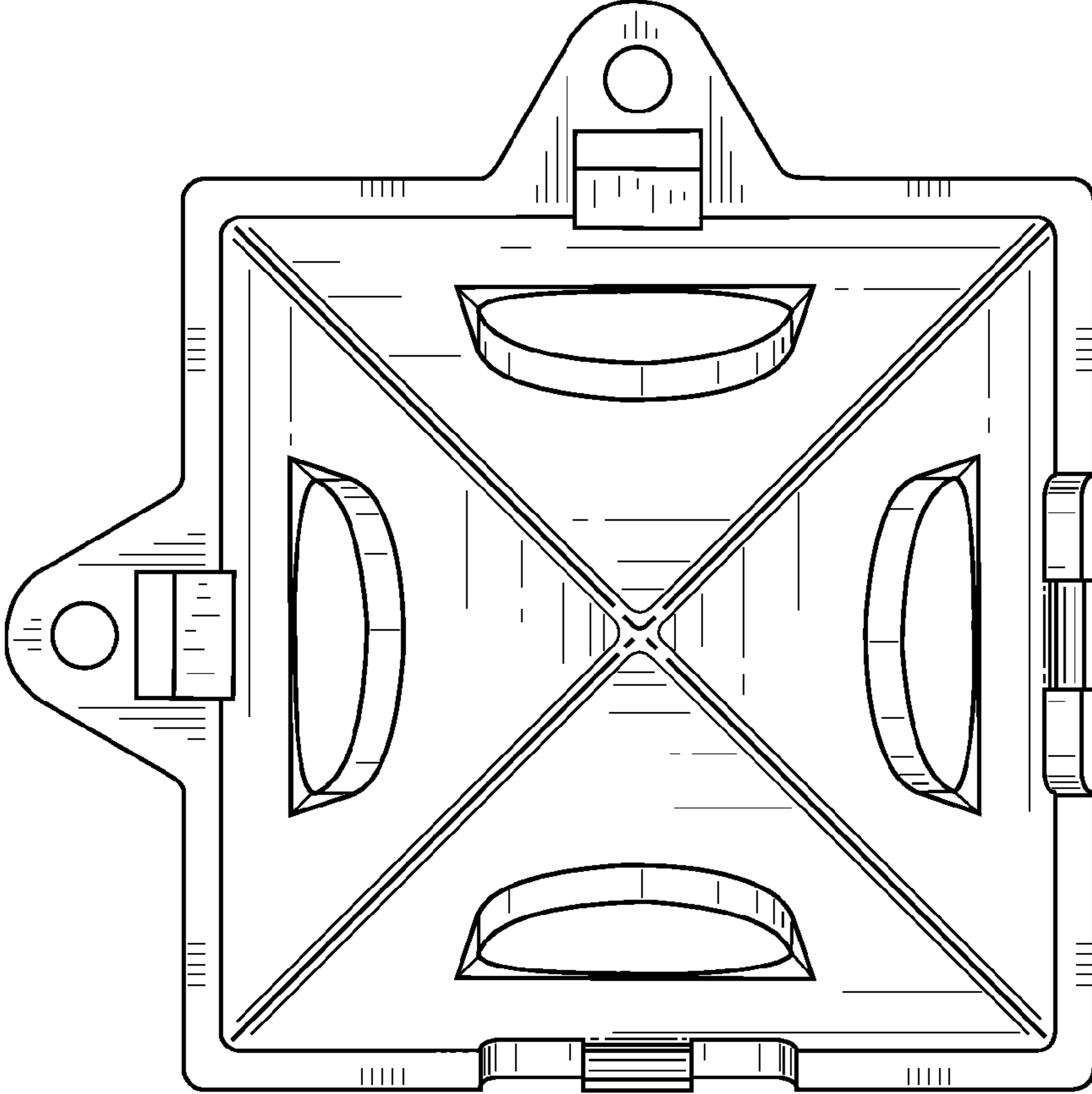

FIG. 12