



US00D634928S

(12) **United States Design Patent**  
**Guyon et al.**

(10) **Patent No.:** **US D634,928 S**  
(45) **Date of Patent:** **\*\* Mar. 29, 2011**

(54) **HANDBAG**

(75) Inventors: **Isabelle Guyon**, Paris (FR); **Sophie Delafontaine**, Versailles (FR); **Philippe Cassegrain**, Paris (FR)

(73) Assignee: **S.A.S. Jean Cassegrain**, Paris (FR)

(\*\*) Term: **14 Years**

(21) Appl. No.: **29/363,998**

(22) Filed: **Jun. 17, 2010**

(30) **Foreign Application Priority Data**

Dec. 21, 2009 (EM) ..... 001650441

(51) **LOC (9) Cl.** ..... **03-01**

(52) **U.S. Cl.** ..... **D3/243**

(58) **Field of Classification Search** ..... D3/232,  
D3/243; 150/100, 103-110, 113-114, 118-119  
See application file for complete search history.

(56) **References Cited**

**U.S. PATENT DOCUMENTS**

D441,528 S \* 5/2001 Guyon ..... D3/242  
D452,074 S 12/2001 Guyon  
D452,372 S 12/2001 Guyon  
D533,345 S 12/2006 Guyon

D534,350 S 1/2007 Guyon  
D535,474 S 1/2007 Guyon  
D539,535 S 4/2007 Guyon  
D570,107 S 6/2008 Guyon et al.  
D594,652 S 6/2009 Guyon et al.  
D604,505 S \* 11/2009 Gerbi ..... D3/244

**OTHER PUBLICATIONS**

“Collection Printemps”, Longchamp, Paris, 2010.  
“Collection Automne”, Longchamp, Paris, 2010.

\* cited by examiner

*Primary Examiner* — Holly H Baynham

(74) *Attorney, Agent, or Firm* — Gottlieb, Rackman & Reisman, P.C.

(57) **CLAIM**

The ornamental design for a handbag, as shown and described.

**DESCRIPTION**

FIG. 1 is a front elevation view of our new design;  
FIG. 2 is a rear elevation view thereof;  
FIG. 3 is a left side elevation view thereof;  
FIG. 4 is a right side elevation view thereof;  
FIG. 5 is a top plan view thereof; and,  
FIG. 6 is a bottom plan view thereof.

The broken lines showing stitching is part of the claimed design.

**1 Claim, 4 Drawing Sheets**

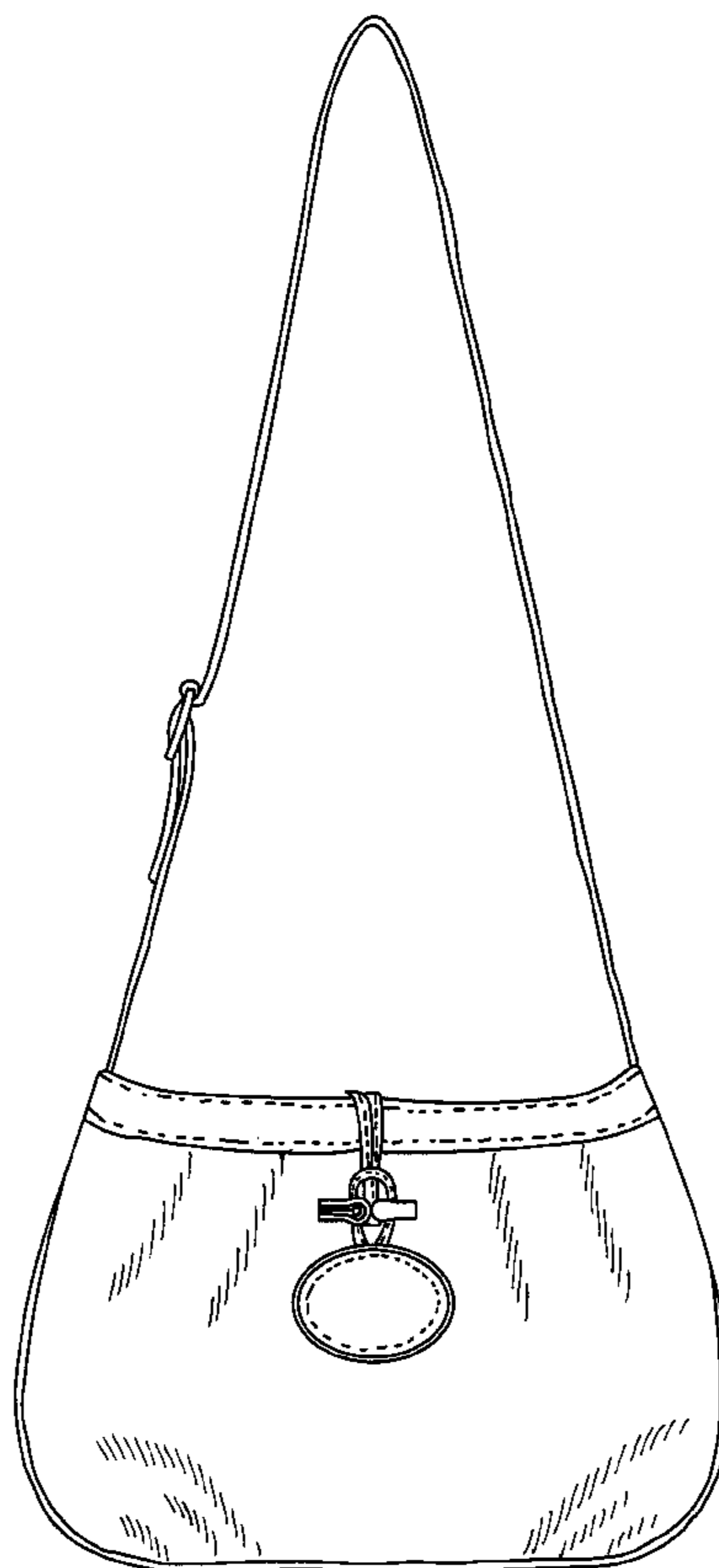

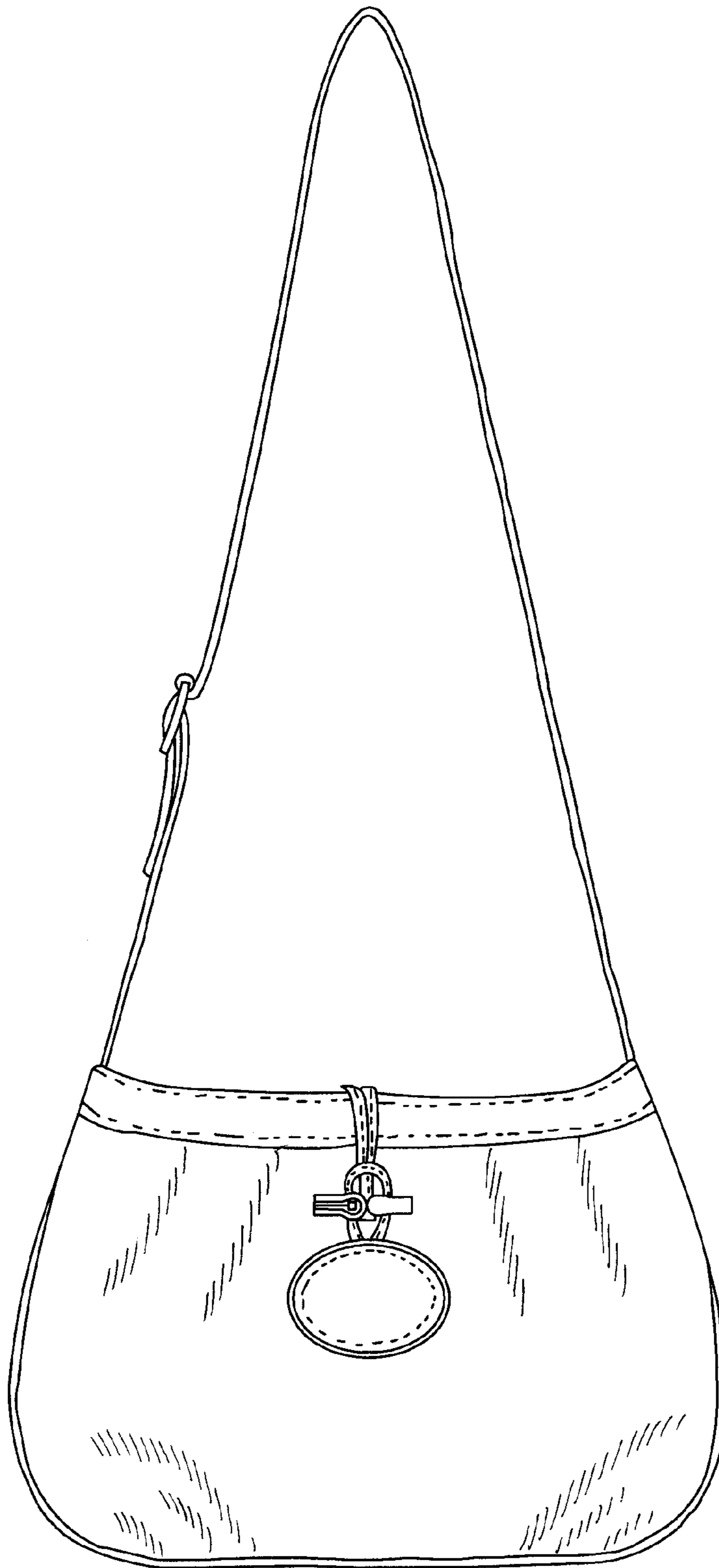

FIG. 1

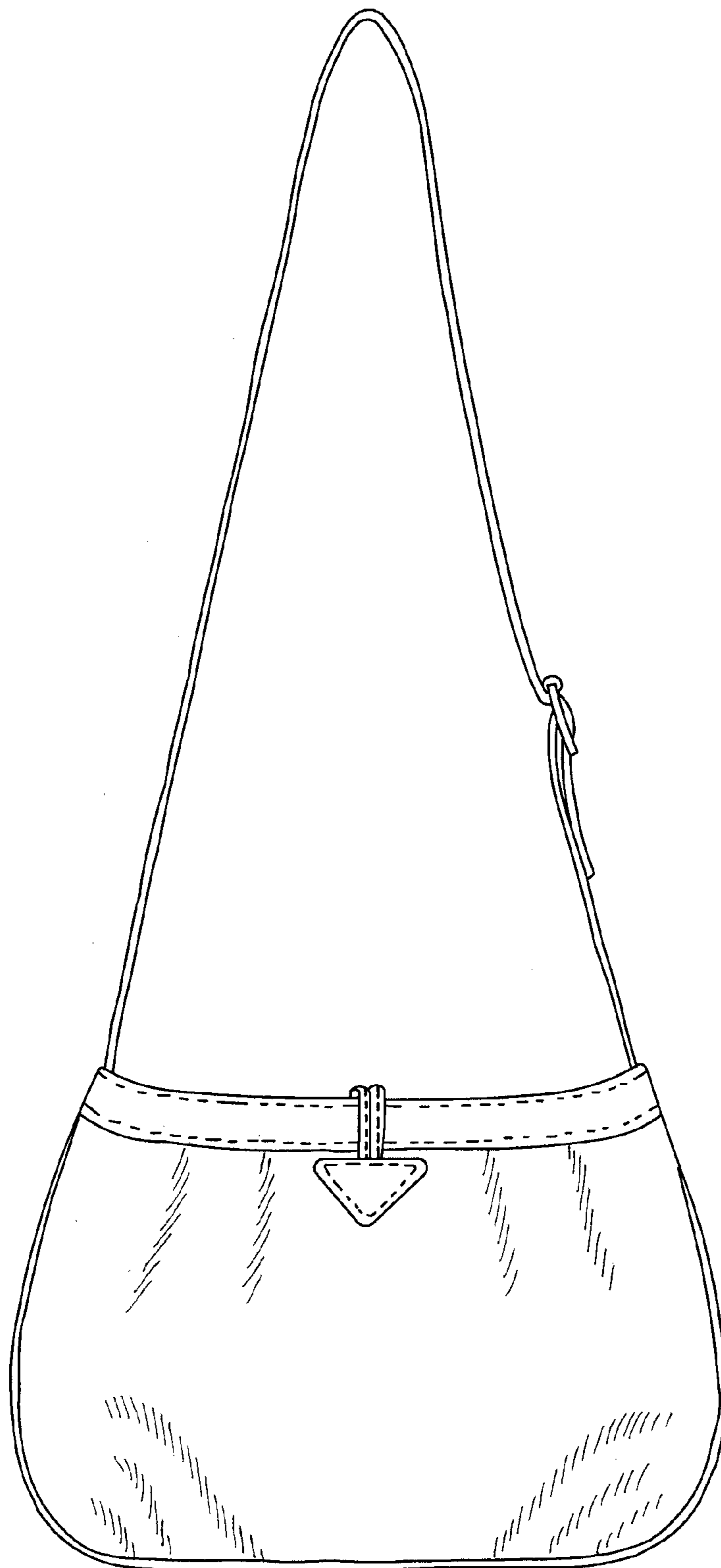

FIG. 2

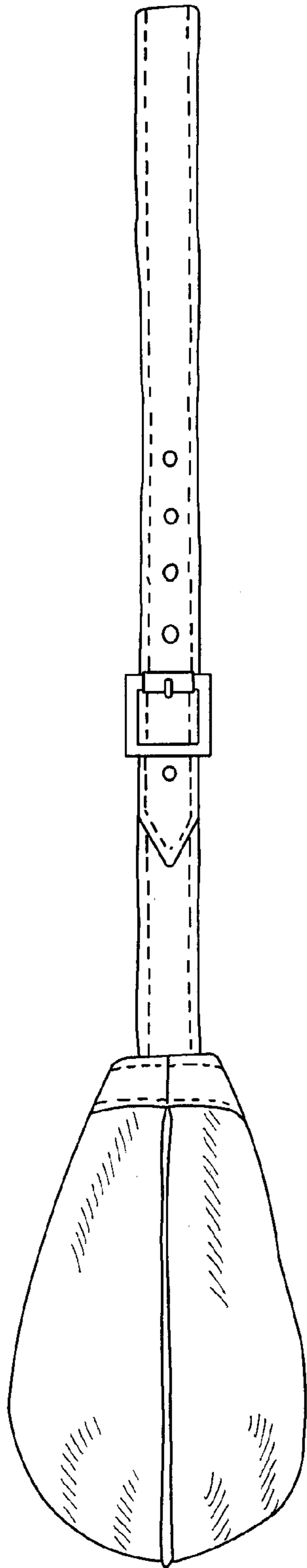

FIG. 3

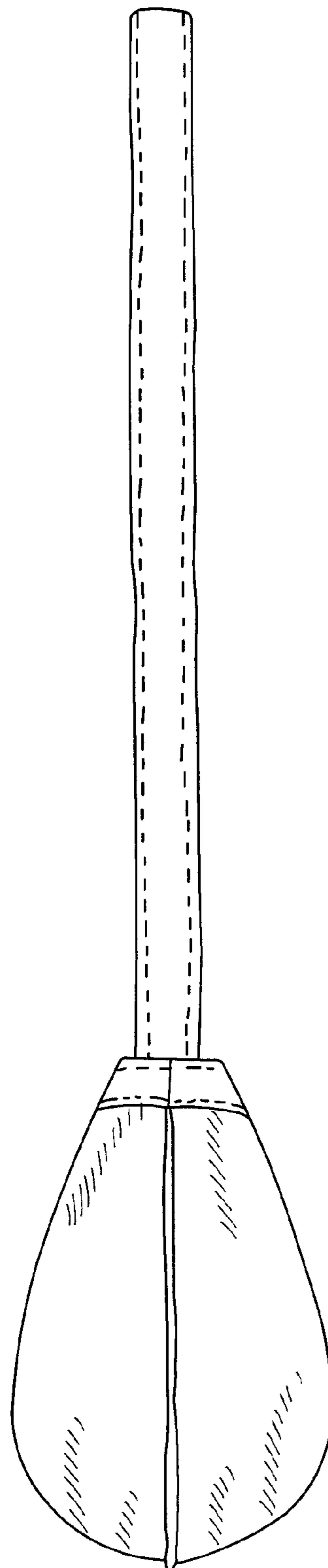

FIG. 4

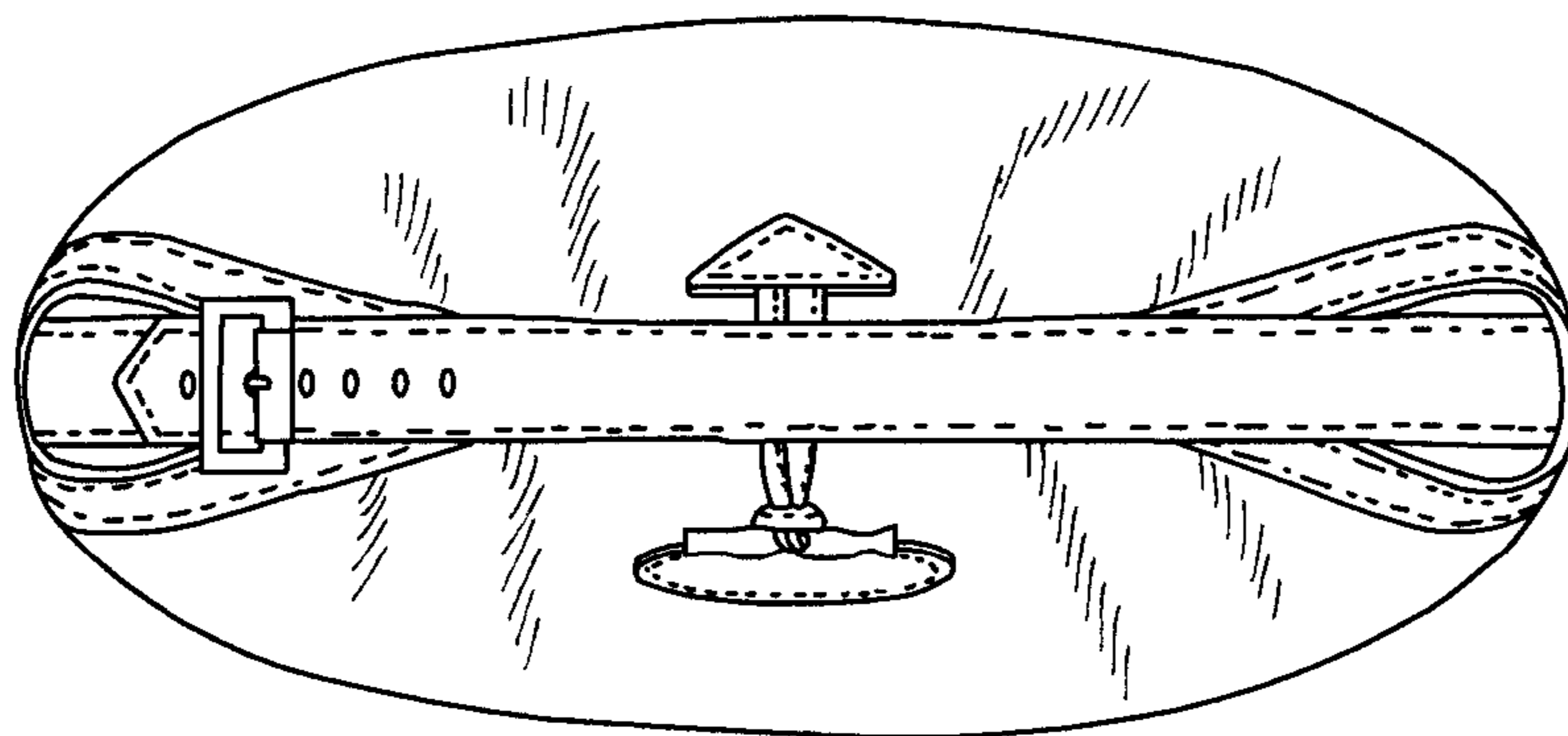

FIG. 5

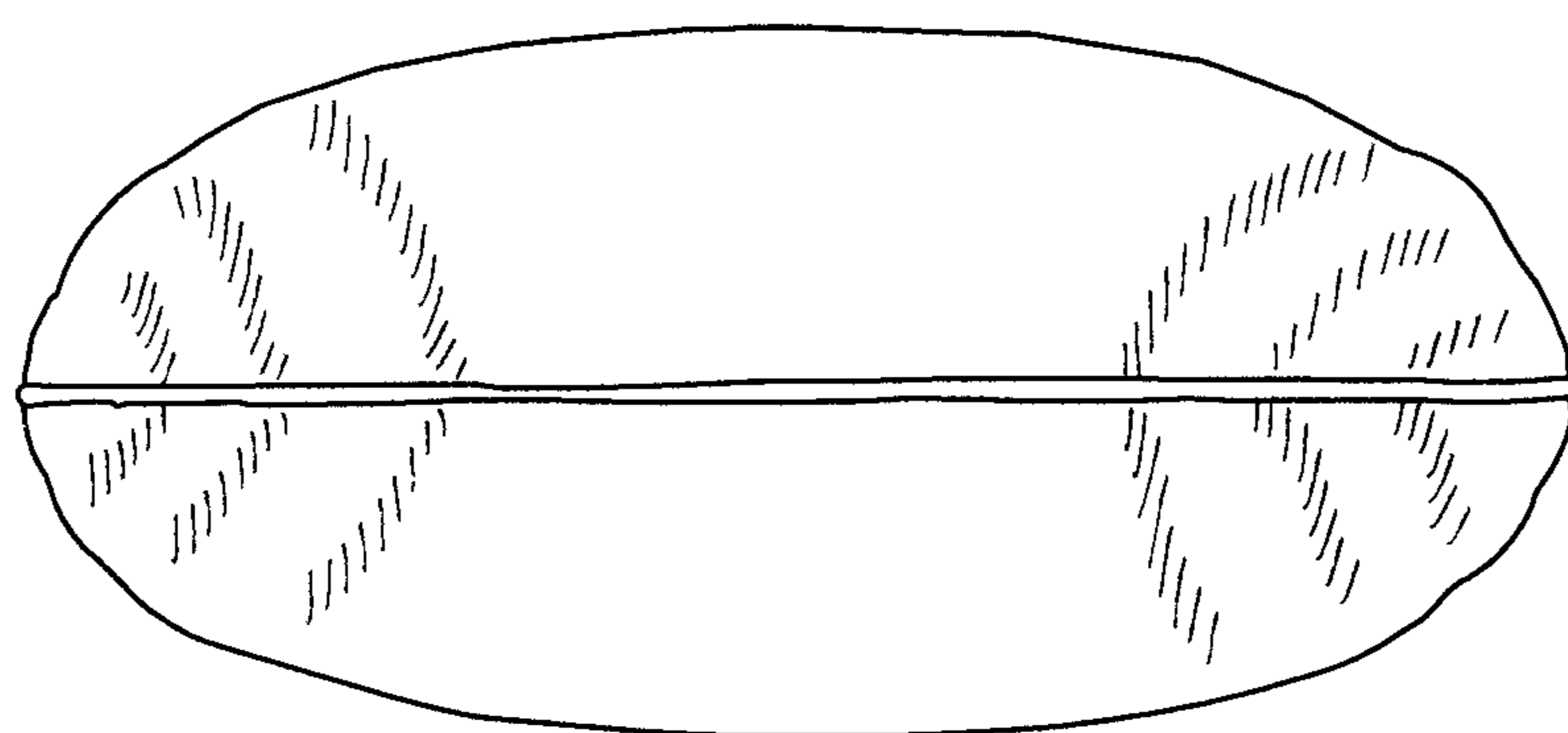

FIG. 6