



US00D634927S

(12) **United States Design Patent**
Boyd et al.

(10) **Patent No.:** **US D634,927 S**
(45) **Date of Patent:** **** Mar. 29, 2011**

(54) **GLASSES HOLDER**

(75) Inventors: **Michael C. Boyd**, Boulder, CO (US);
Bowden Ormsbee, Longmont, CO (US)

(73) Assignee: **Nite Ize, Inc.**, Boulder, CO (US)

(**) Term: **14 Years**

(21) Appl. No.: **29/365,511**

(22) Filed: **Jul. 9, 2010**

(51) **LOC (9) Cl.** **03-01**

(52) **U.S. Cl.** **D3/219**

(58) **Field of Classification Search** D3/219,
D3/215, 218, 263–267, 273, 294–295; 206/5,
206/5.1, 6, 811; 248/902
See application file for complete search history.

(56) **References Cited**

U.S. PATENT DOCUMENTS

5,423,419 A * 6/1995 Wentz et al. 206/6
D400,351 S * 11/1998 Hatchiguian D3/219
D406,696 S * 3/1999 Conway D3/265
D437,112 S * 2/2001 Toffoli D3/219

D443,133 S * 6/2001 Richardson et al. D3/215
D485,680 S * 1/2004 Hasenfrantz D3/265
D518,635 S * 4/2006 Carman et al. D3/265

* cited by examiner

Primary Examiner — Catherine R Oliver

(74) *Attorney, Agent, or Firm* — Patton Boggs LLP

(57) **CLAIM**

The ornamental design for glasses holder, as shown and described.

DESCRIPTION

FIG. 1 is a front and right side perspective view of the glasses holder showing our new design;
FIG. 2 is a rear and right side perspective view of the glasses holder shown in FIG. 1;
FIG. 3 is a front view of the glasses holder of FIG. 1;
FIG. 4 is a rear view of the glasses holder of FIG. 1;
FIG. 5 is a left side view of the glasses holder of FIG. 1;
FIG. 6 is a right side view of the glasses holder of FIG. 1;
FIG. 7 is a top view of the glasses holder of FIG. 1; and,
FIG. 8 is a bottom view of the glasses holder of FIG. 1.

1 Claim, 6 Drawing Sheets

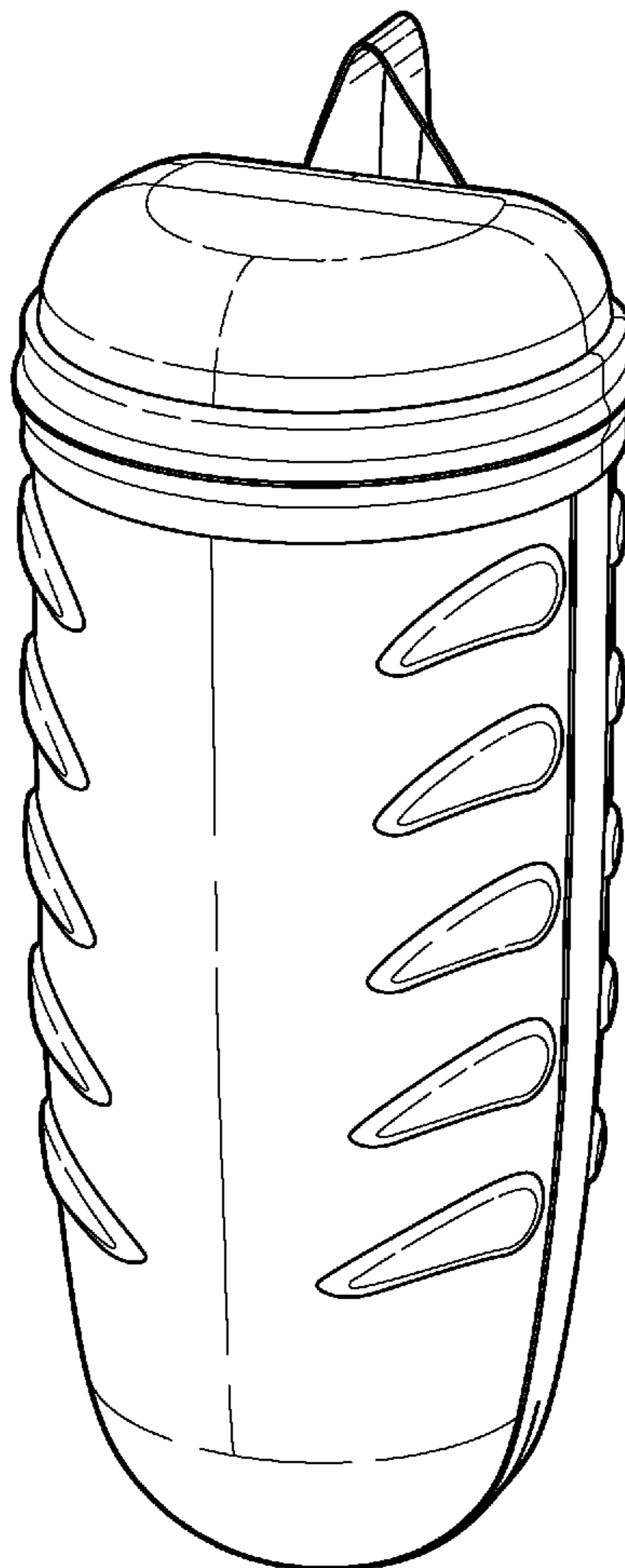

FIG. 1

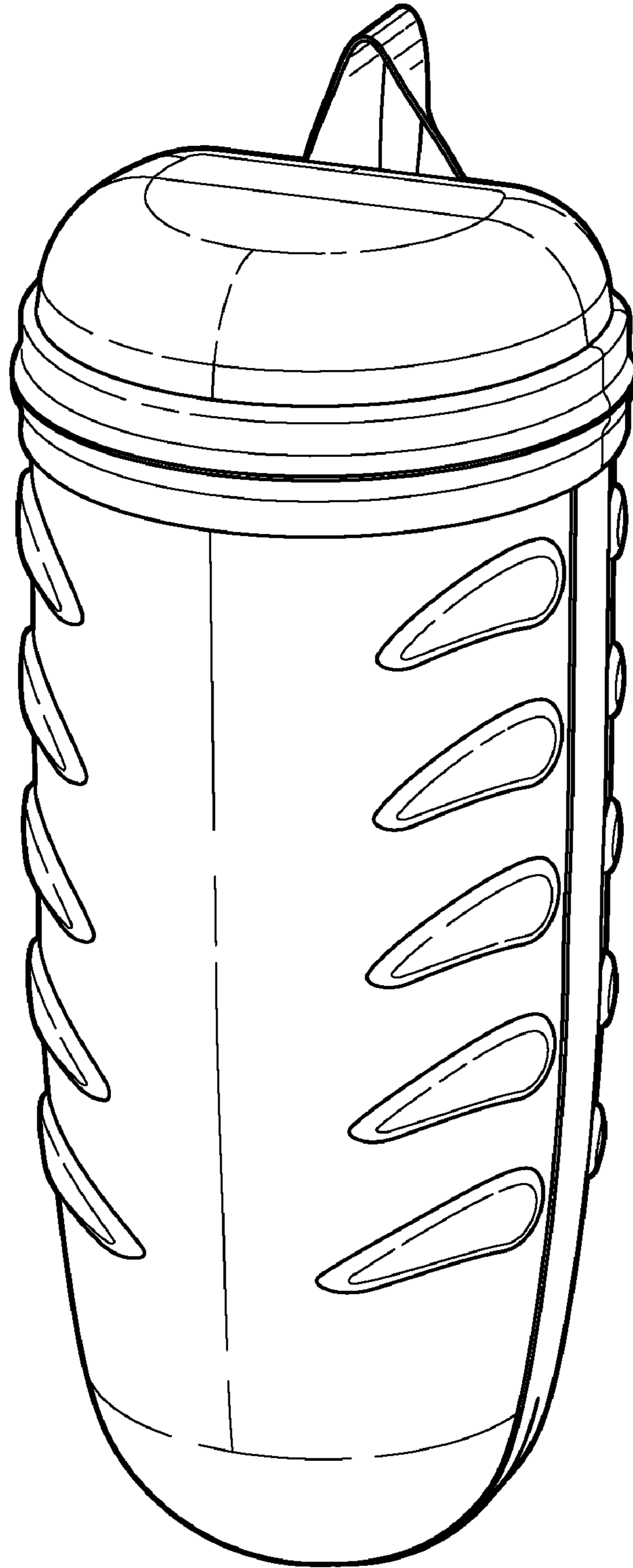

FIG. 2

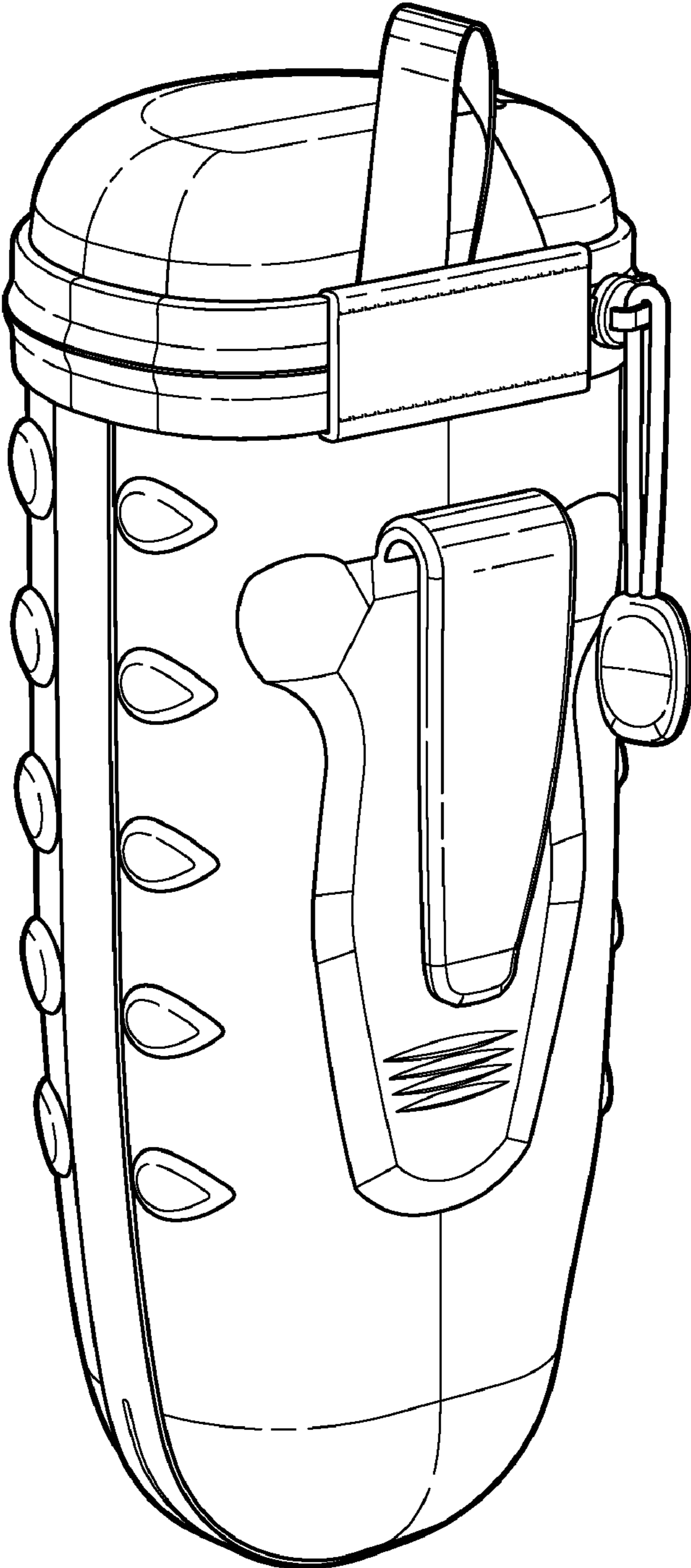

FIG. 3

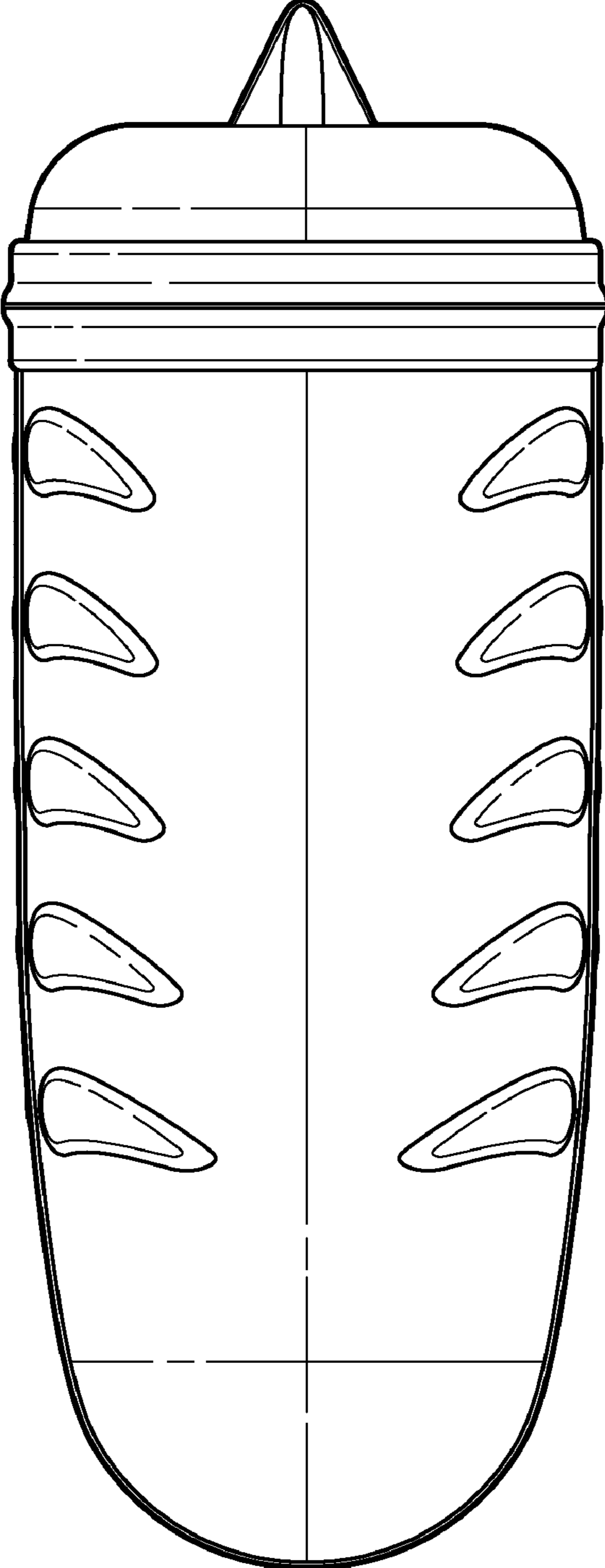

FIG. 4

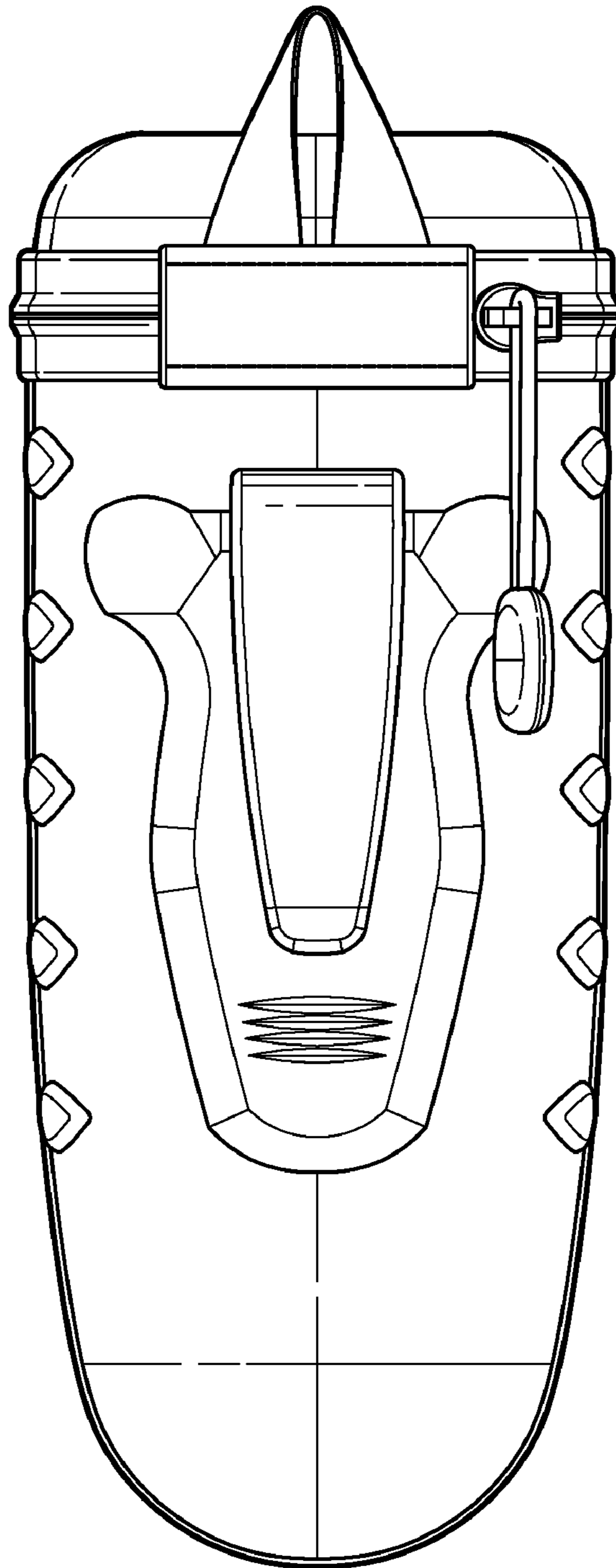

FIG. 5

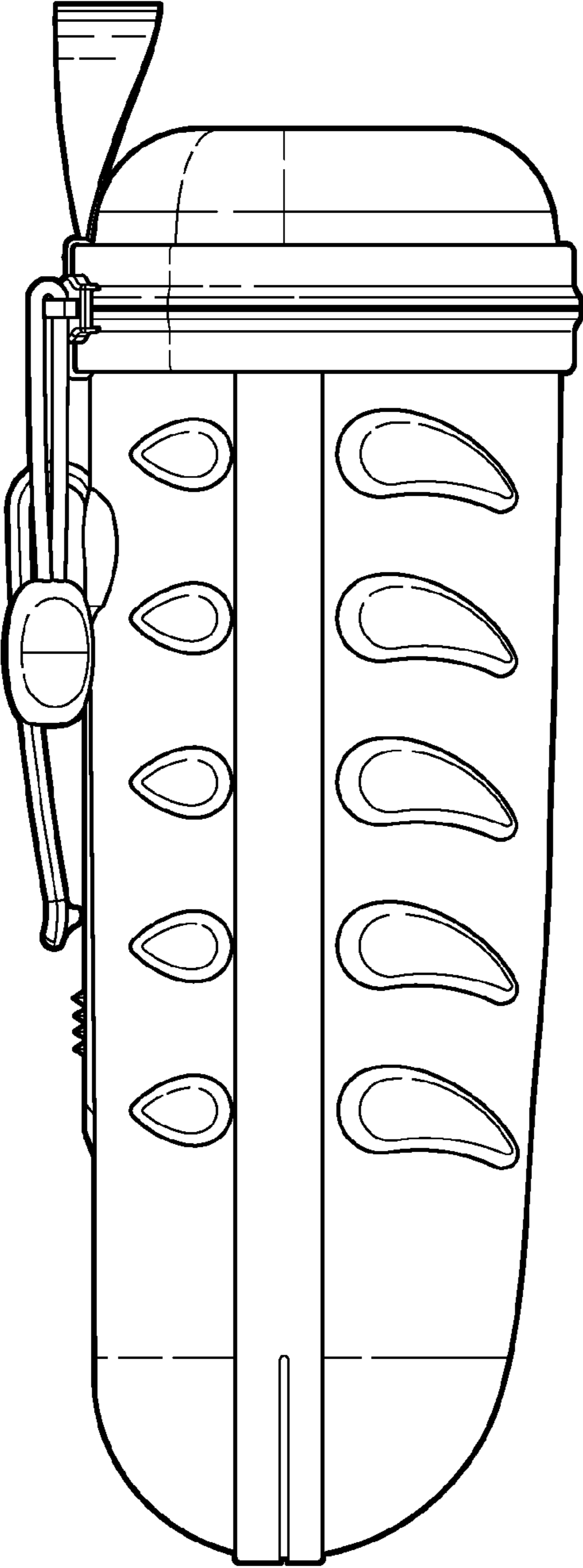

FIG. 6

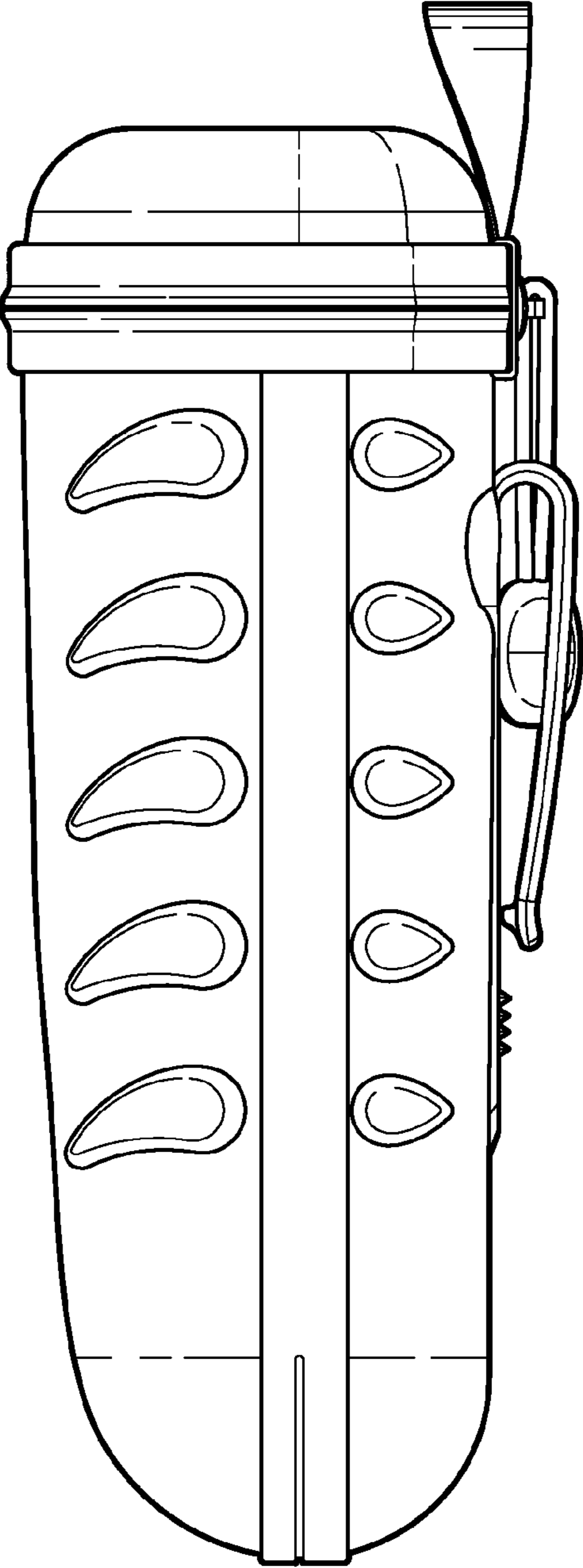

FIG. 7

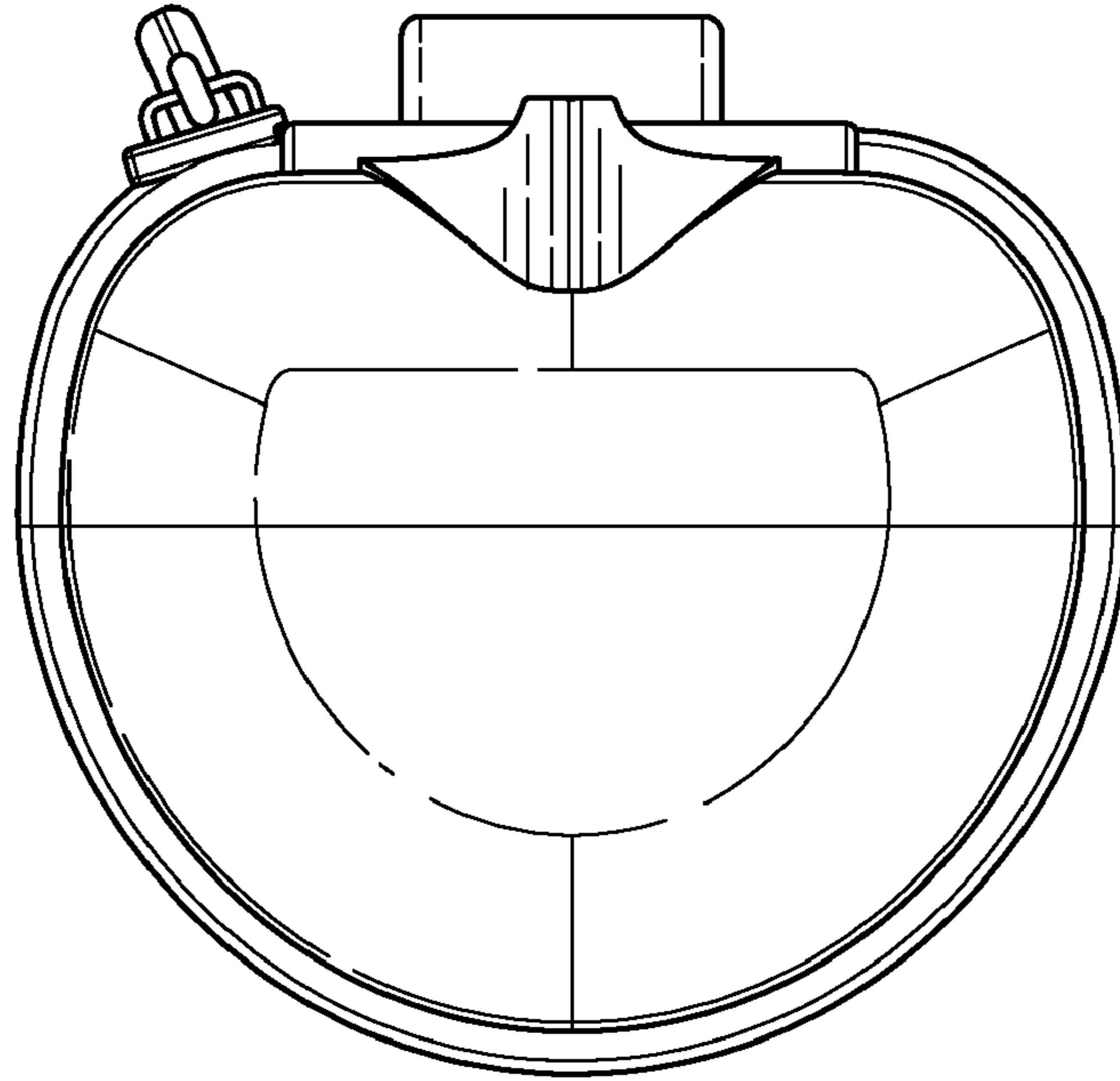

FIG. 8

