



US00D634894S

(12) **United States Design Patent**
Cataudella

(10) **Patent No.:** **US D634,894 S**

(45) **Date of Patent:** **** Mar. 22, 2011**

(54) **SHAVING RAZOR HANDLE**

(75) Inventor: **Matthew Corey Cataudella**, Boston, MA (US)

(73) Assignee: **The Gillette Company**, Boston, MA (US)

(**) Term: **14 Years**

(21) Appl. No.: **29/363,396**

(22) Filed: **Jun. 9, 2010**

(51) **LOC (9) Cl.** **28-03**

(52) **U.S. Cl.** **D28/48**

(58) **Field of Classification Search** D28/44-48;
30/32, 32.05, 34.1-34.2, 41, 44-46, 47-51,
30/57-58, 77-84, 526-539

See application file for complete search history.

(56) **References Cited**

U.S. PATENT DOCUMENTS

D243,419 S	2/1977	Hedley
4,069,580 A	1/1978	Cartwright et al.
4,392,303 A	7/1983	Ciaffone
4,741,103 A	5/1988	Hultman
5,331,740 A	7/1994	Carson, III et al.
5,590,468 A	1/1997	Prochaska
5,630,275 A	5/1997	Wexler
5,855,071 A	1/1999	Apprille, Jr. et al.
D467,387 S	12/2002	Wonderley
D476,772 S	7/2003	Wonderley
6,584,696 B2	7/2003	Ferraro
6,588,113 B2	7/2003	Bozikis et al.
D478,687 S	8/2003	Provost
D499,511 S	12/2004	Wakayama
D513,540 S	1/2006	Wonderley
D534,316 S	12/2006	Bozikis et al.

D552,795 S	10/2007	Wonderley	
D581,593 S *	11/2008	Rhoad	D28/48
D581,595 S *	11/2008	Micinilio et al.	D28/48
D587,846 S	3/2009	Wonderley et al.	
D599,955 S	9/2009	Provost	
D602,634 S	10/2009	Cataudella et al.	
D603,098 S *	10/2009	Cataudella	D28/48
D607,150 S	12/2009	Furuta	
D616,607 S *	5/2010	Ramm et al.	D28/48
D624,243 S *	9/2010	Rhoad	D28/47
D624,700 S *	9/2010	Jung	D28/46
2007/0193042 A1	8/2007	Worrick et al.	
2008/0115366 A1	5/2008	Follo et al.	
2010/0175270 A1	7/2010	Psimadas et al.	

* cited by examiner

Primary Examiner — Jennifer Rivard

(74) *Attorney, Agent, or Firm* — John M. Lipchitz; Kevin C. Johnson; Steven W. Miller

(57) **CLAIM**

The ornamental design for a shaving razor handle, as shown and described.

DESCRIPTION

FIG. 1 is a perspective view of a shaving razor handle of the present invention;
FIG. 2 is a top view thereof;
FIG. 3 is a bottom view thereof;
FIG. 4 is a right view thereof;
FIG. 5 is a left view thereof;
FIG. 6 is a front view thereof;
FIG. 7 is a rear view thereof; and,
FIG. 8 is a second perspective view thereof.
The broken lines are shown for illustrative purposes only and form no part of the claimed design.

1 Claim, 6 Drawing Sheets

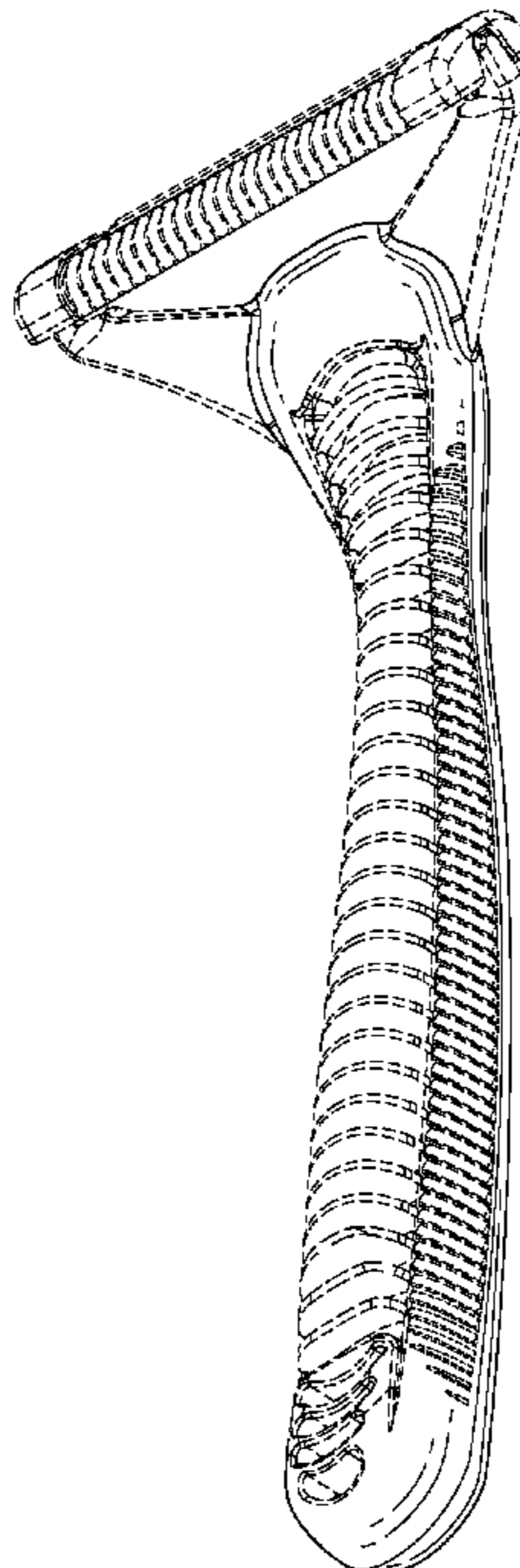
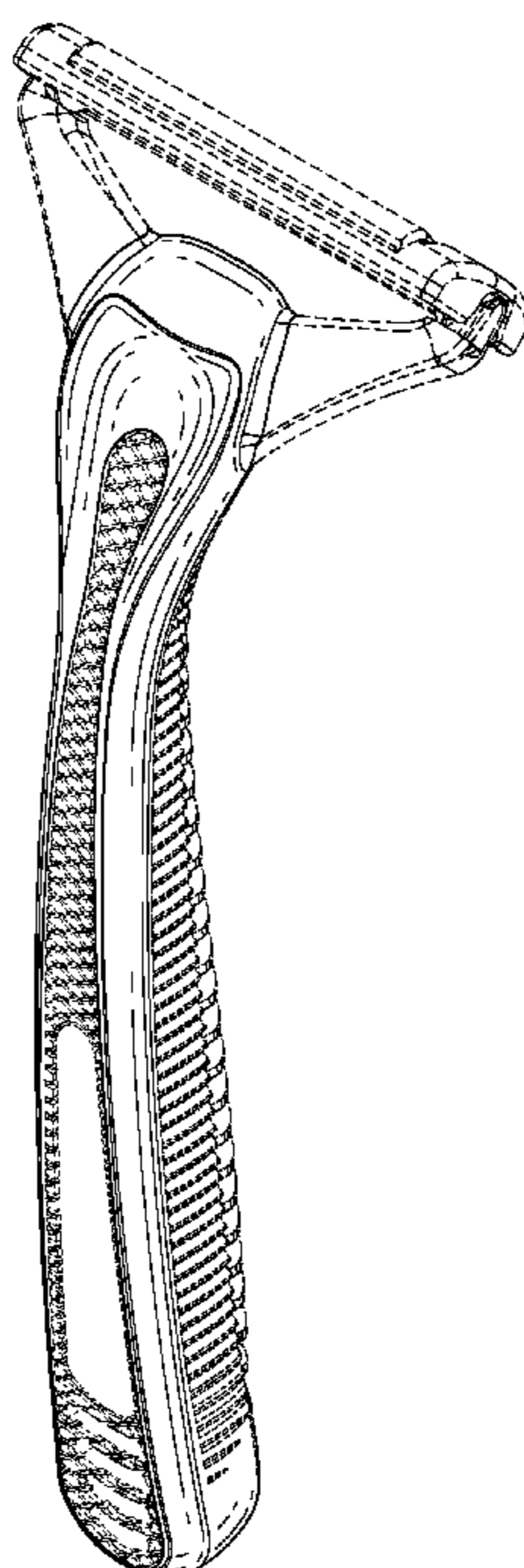
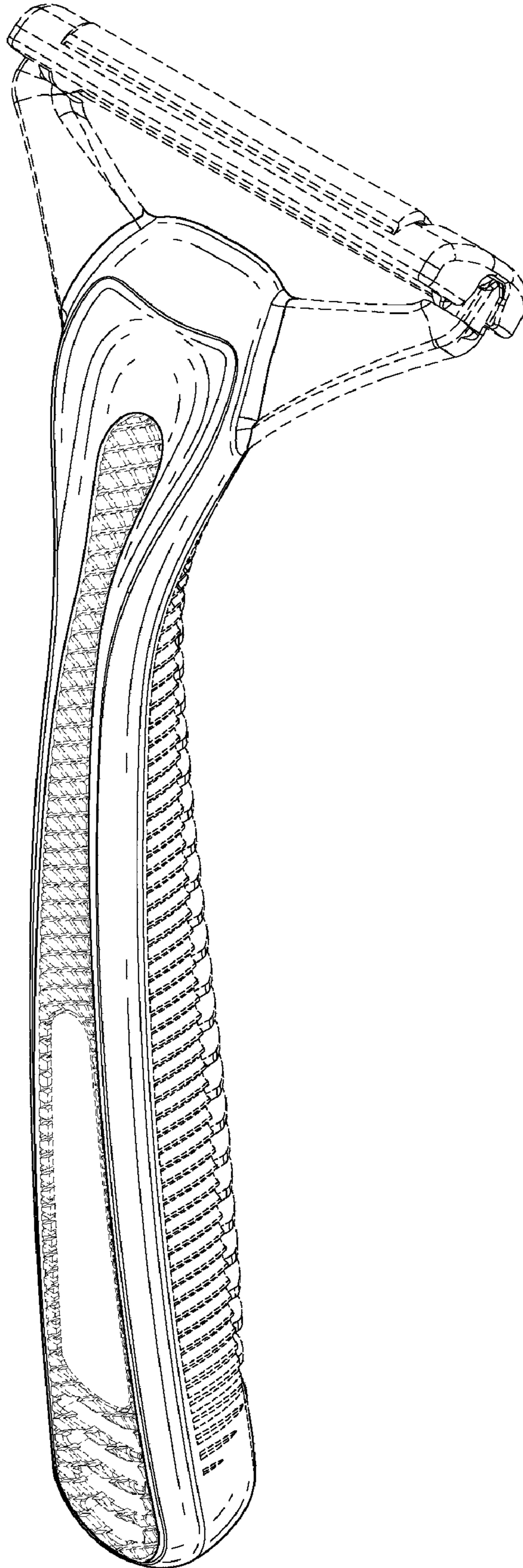

FIG. 1



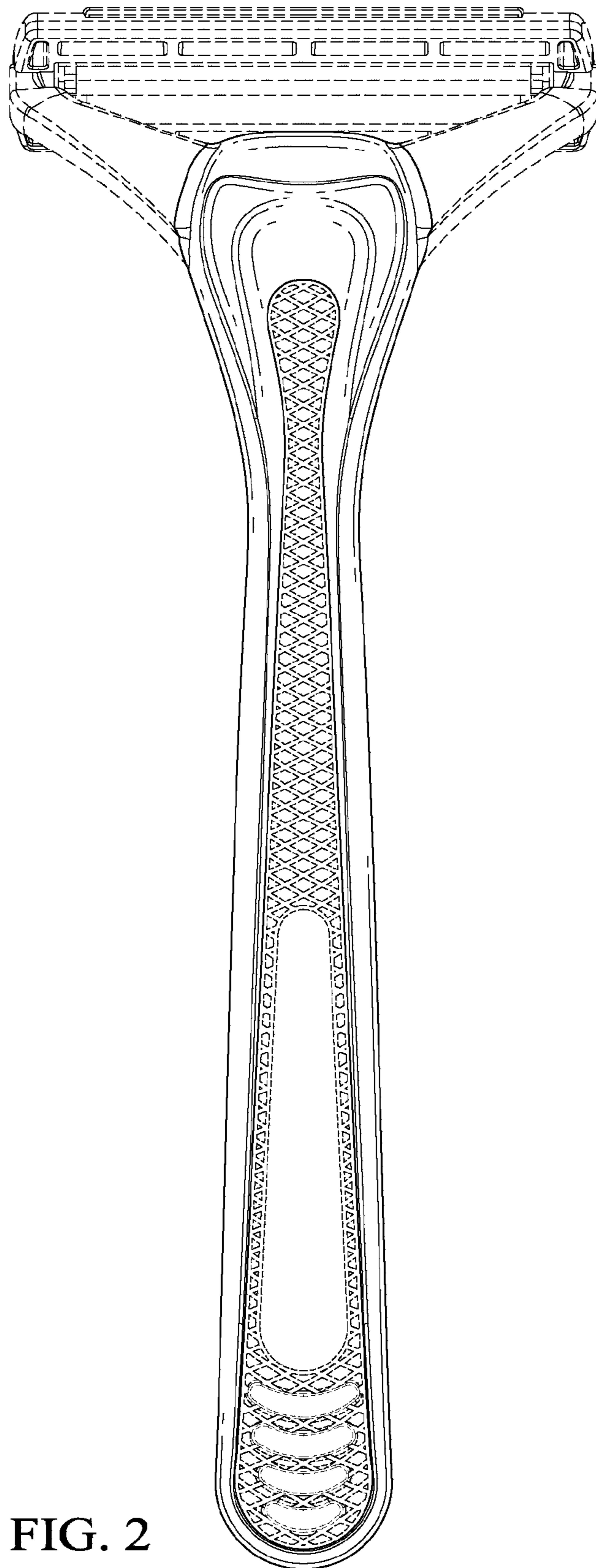

FIG. 2

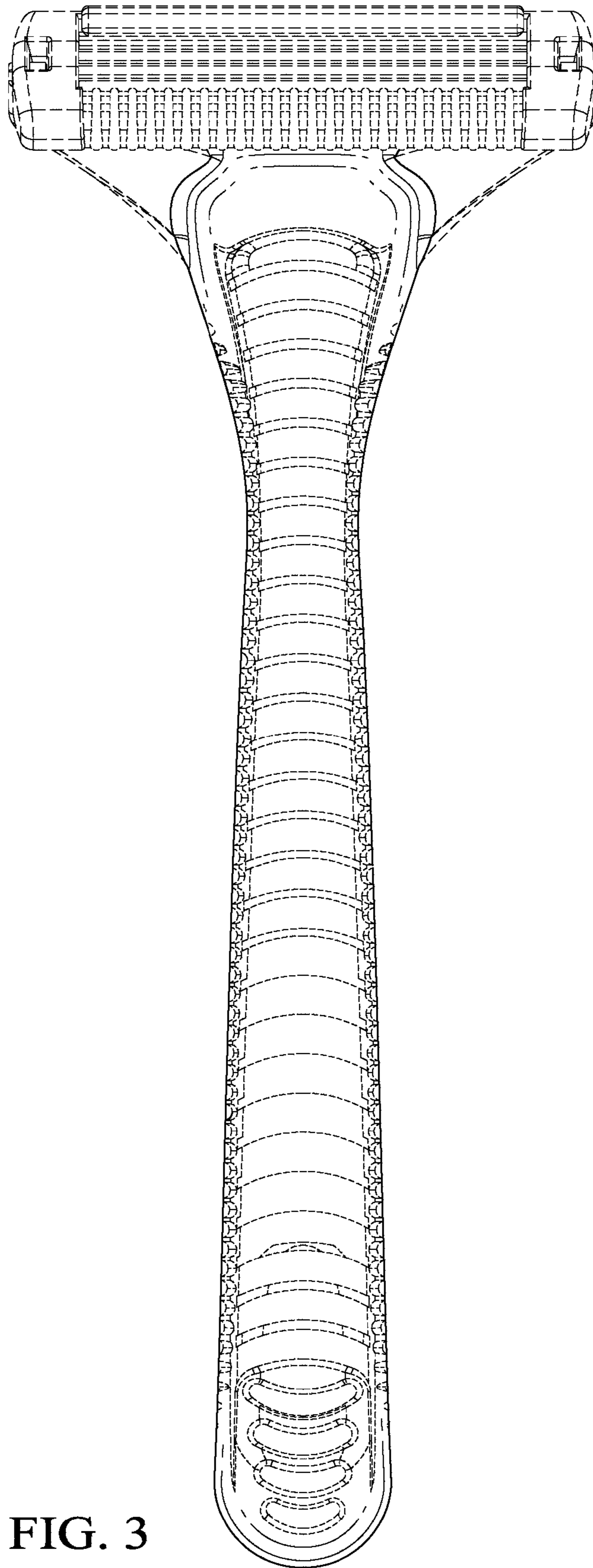

FIG. 3

FIG. 4

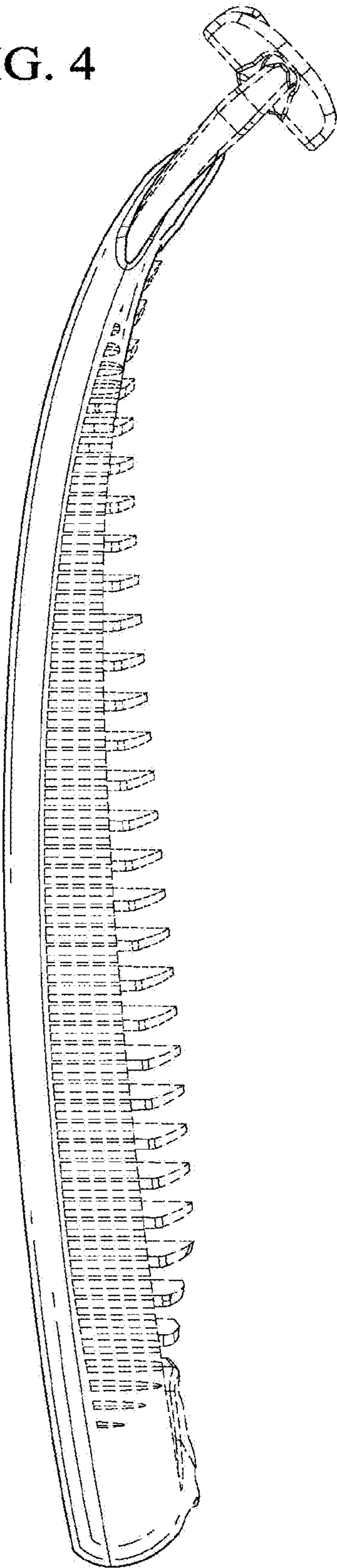
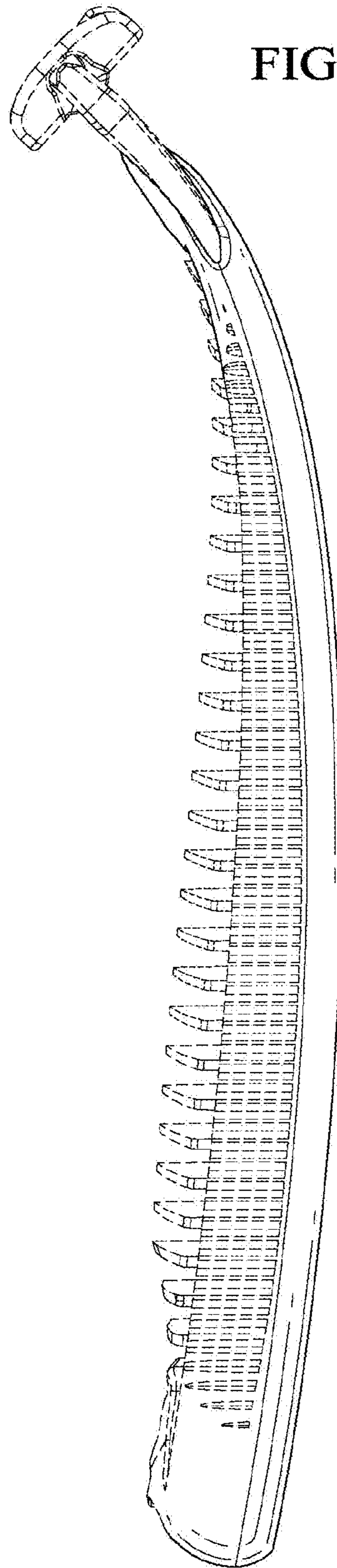

FIG. 5



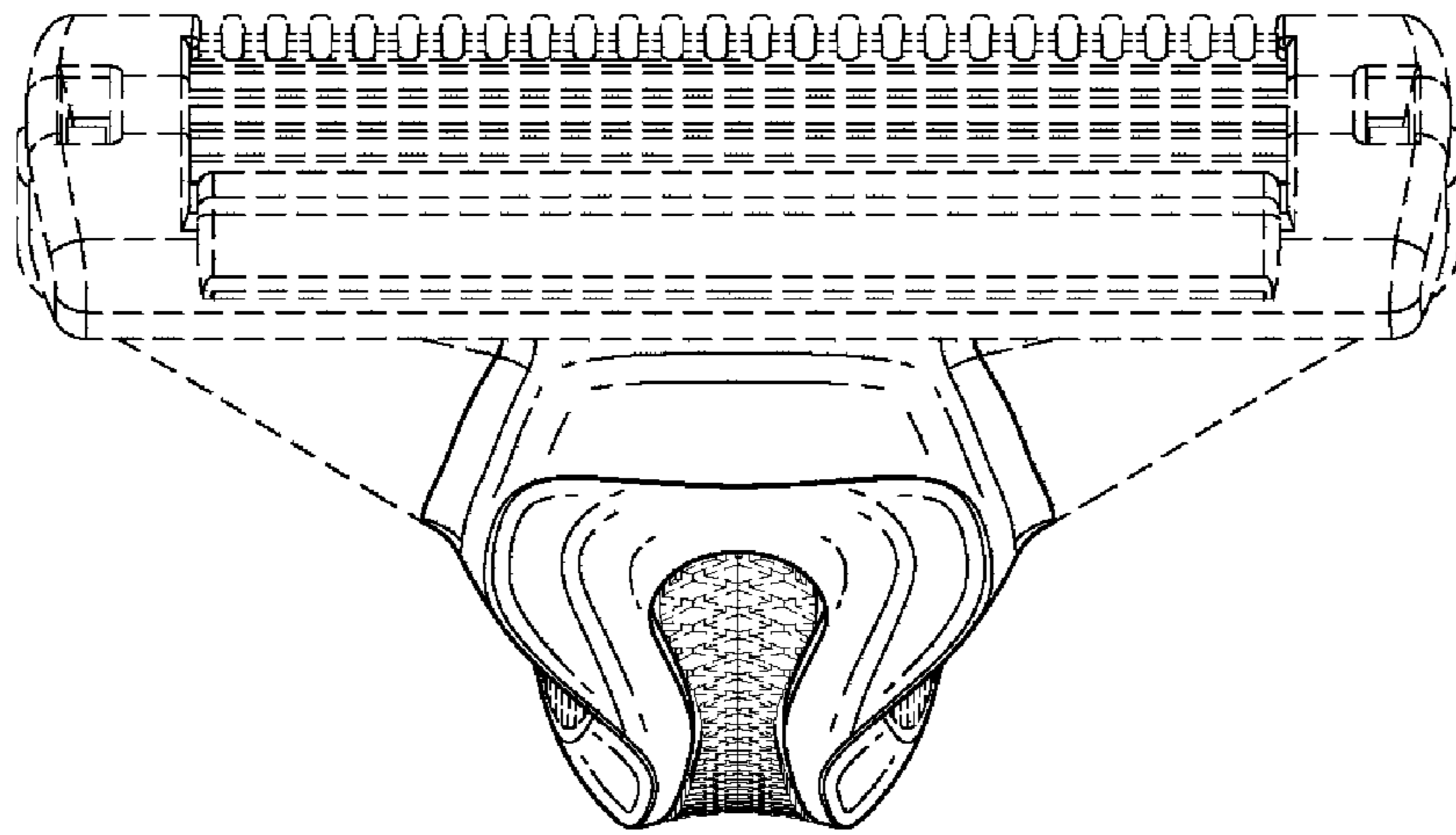

FIG. 6

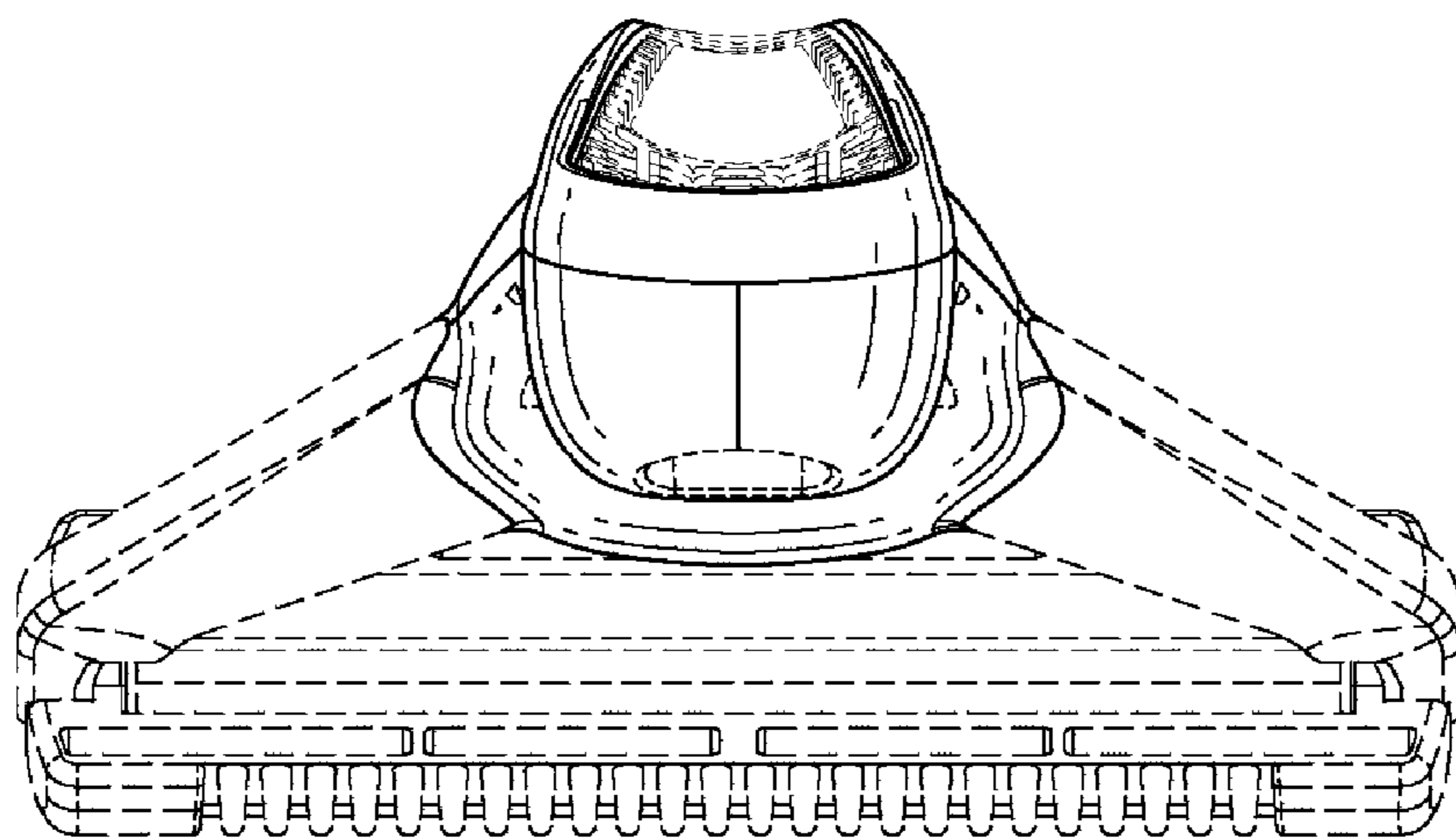

FIG. 7

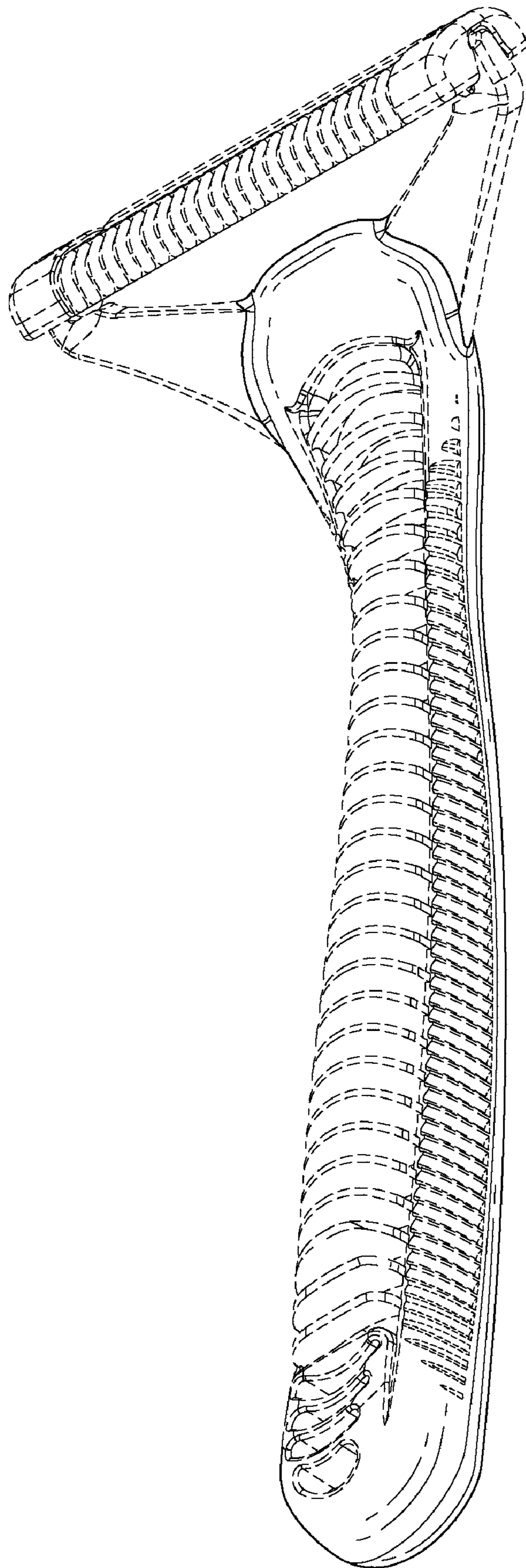

FIG. 8