



US00D634854S

(12) **United States Design Patent**
Lynch et al.

(10) **Patent No.:** **US D634,854 S**

(45) **Date of Patent:** **** Mar. 22, 2011**

(54) **DOOR FACING**

(75) Inventors: **Steven K. Lynch**, St. Charles, IL (US);
Gregory J. Wysock, Sycamore, IL (US);
Hallie L. Heuser, Geneva, IL (US)

(73) Assignee: **Masonite Corporation**, Tampa, FL (US)

(**) Term: **14 Years**

(21) Appl. No.: **29/359,305**

(22) Filed: **Apr. 8, 2010**

Related U.S. Application Data

(60) Division of application No. 29/339,685, filed on Jul. 6, 2009, now Pat. No. Des. 614,312, which is a continuation of application No. 29/318,085, filed on May 13, 2008, now abandoned.

(51) **LOC (9) Cl.** **25-02**

(52) **U.S. Cl.** **D25/48**

(58) **Field of Classification Search** D25/48;
52/455, 456, 311.1; 49/DIG. 2, 504
See application file for complete search history.

(56) **References Cited**

U.S. PATENT DOCUMENTS

4,006,571 A * 2/1977 Bursk 52/802.11
D460,564 S * 7/2002 Ben-Ezra D25/48
D495,062 S * 8/2004 Lynch et al. D25/48
2005/0102908 A1 * 5/2005 Martin 49/455

* cited by examiner

Primary Examiner — Doris Clark

(74) *Attorney, Agent, or Firm* — Berenato & White, LLC

(57) **CLAIM**

The ornamental design for a door facing, as shown and described.

DESCRIPTION

FIG. 1 is a front perspective view of a first embodiment of our design;

FIG. 2 is a front elevational view thereof;

FIG. 3 is a rear elevational view;

FIG. 4 is a top plan view;

FIG. 5 is a bottom plan view;

FIG. 6 is a cross-sectional view taken along the line 6—6 of FIG. 2 and viewed in the direction of the arrows;

FIG. 7 is an enlarged fragmented left side cross-sectional view of FIG. 6;

FIG. 8 is a left side elevational view;

FIG. 9 is a right side elevational view; and

FIG. 10 is a cross-sectional view taken along the line 10—10 of FIG. 2 and viewed in the direction of the arrows;

FIG. 11 is a front perspective view of a second embodiment of our design;

FIG. 12 is a front elevational view thereof;

FIG. 13 is a rear elevational view;

FIG. 14 is a top plan view;

FIG. 15 is a bottom plan view;

FIG. 16 is a cross-sectional view taken along the line 16—16 of FIG. 12 and viewed in the direction of the arrows;

FIG. 17 is an enlarged fragmented left side cross-sectional view of FIG. 16;

FIG. 18 is a left side elevational view;

FIG. 19 is a right side elevational view; and

FIG. 20 is a cross-sectional view taken along the line 20—20 of FIG. 12 and viewed in the direction of the arrows.

The broken lines showing of a door facing is for the purposes of illustrating environmental structure and forms no part of the claimed design.

1 Claim, 10 Drawing Sheets

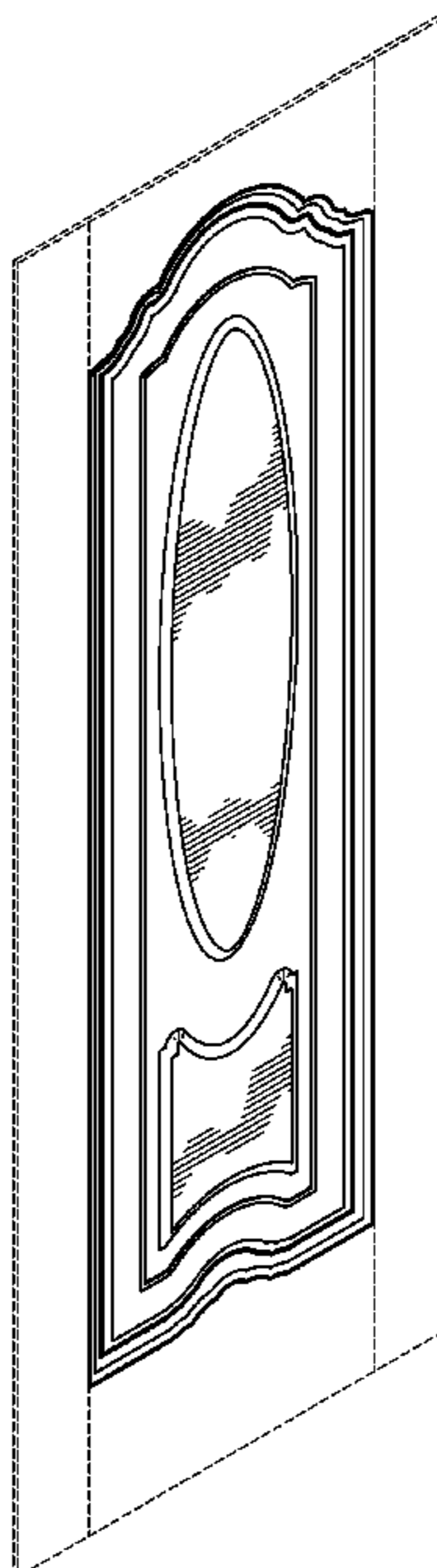
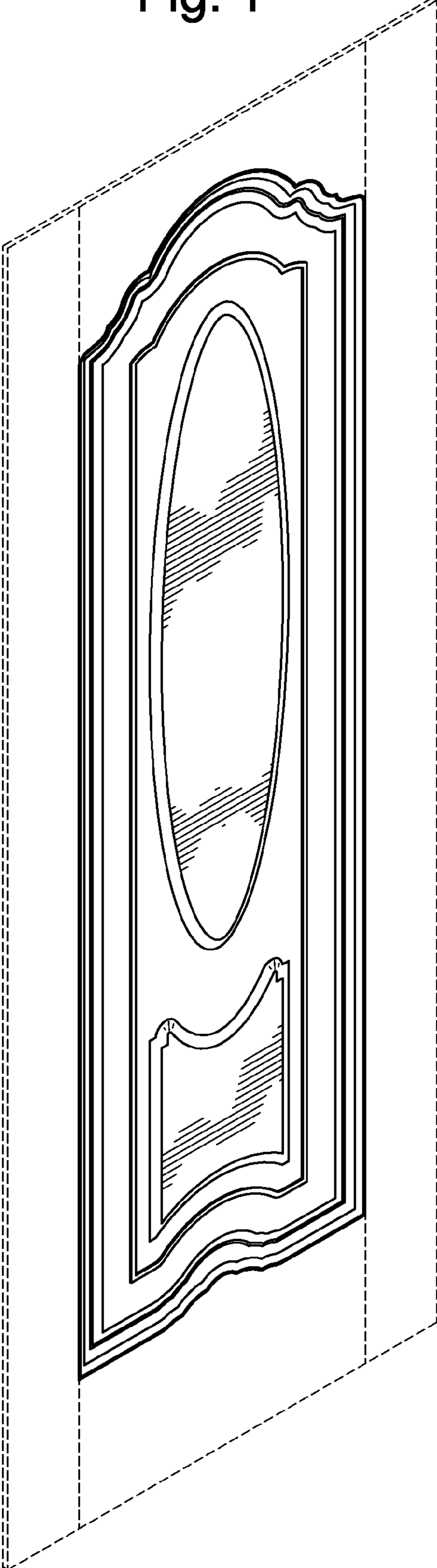

Fig. 1



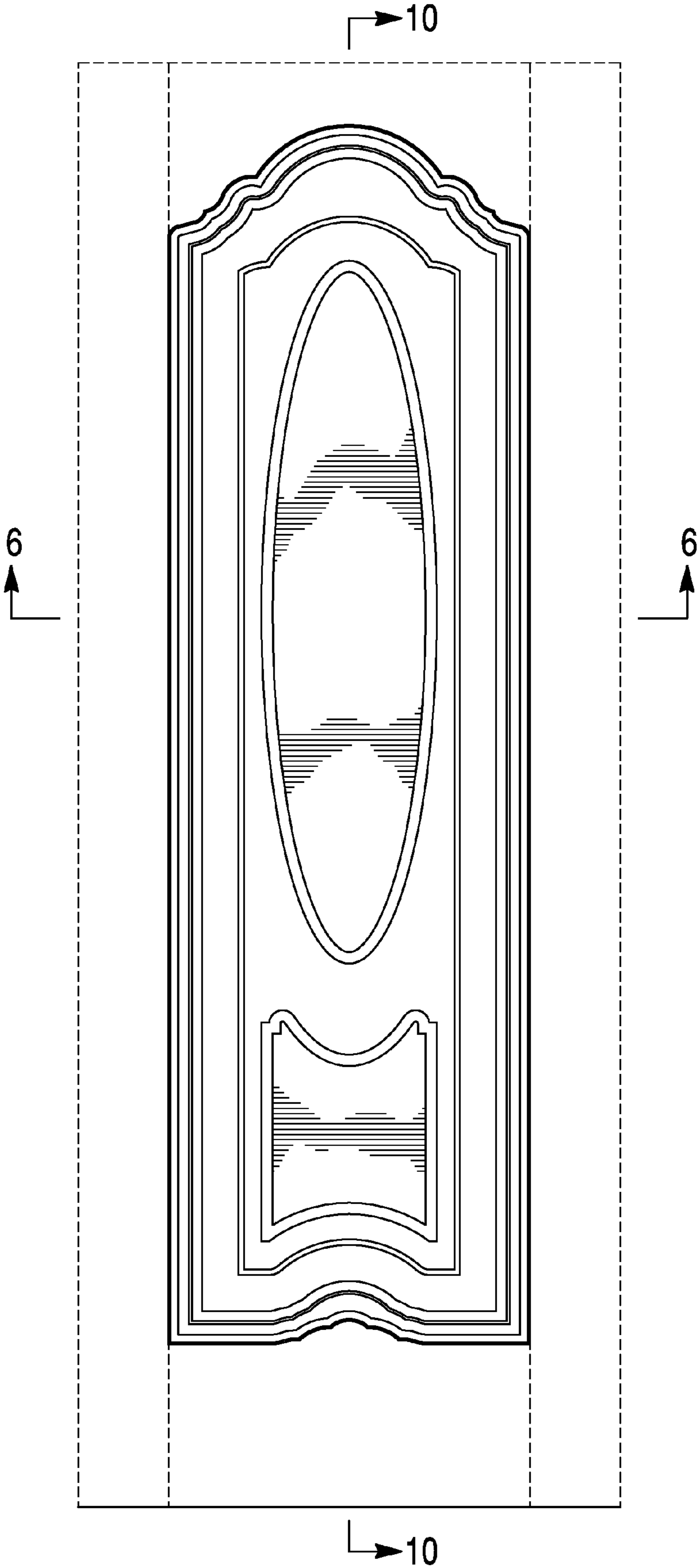

Fig. 2

Fig. 3

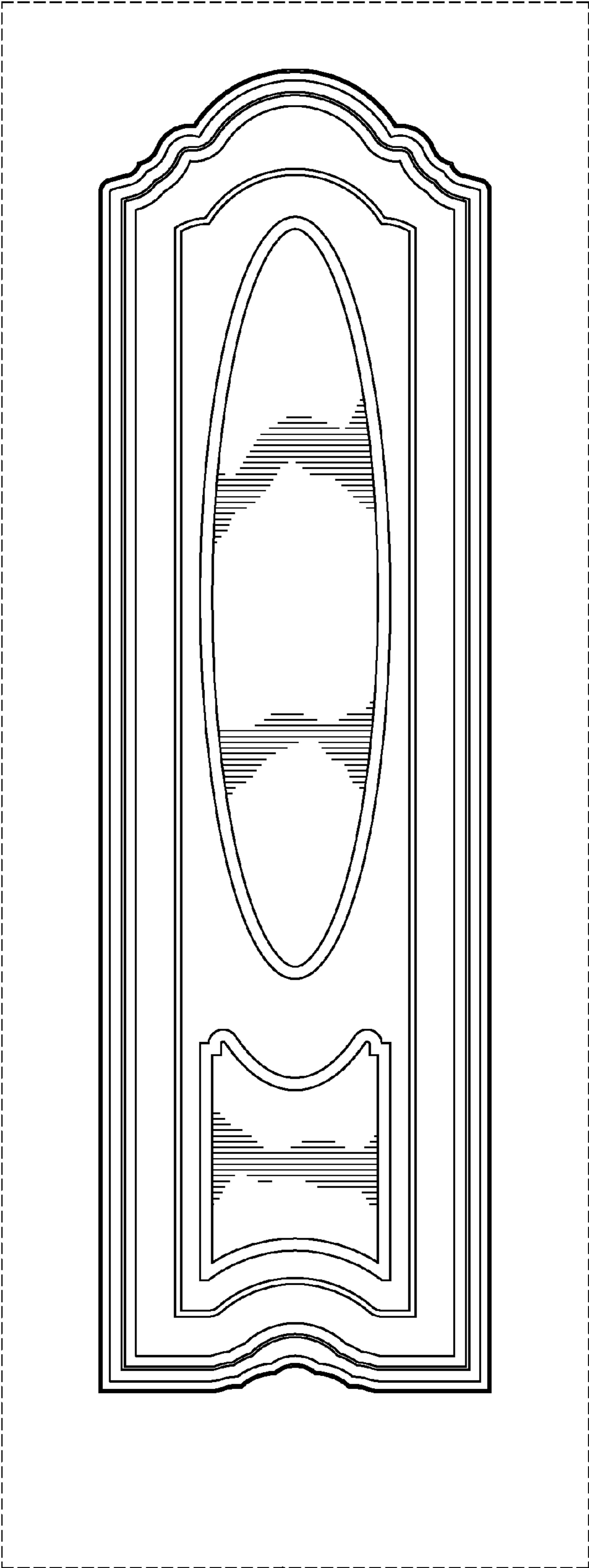

Fig. 4



Fig. 5



Fig. 6

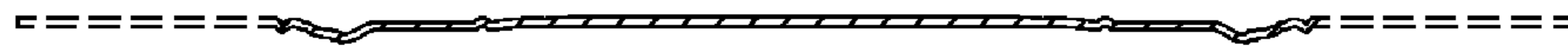

Fig. 7

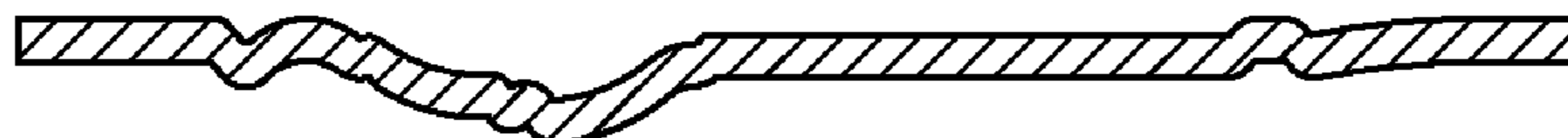

Fig. 8



Fig. 9



Fig. 10

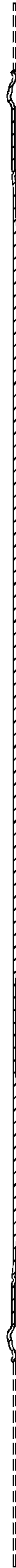
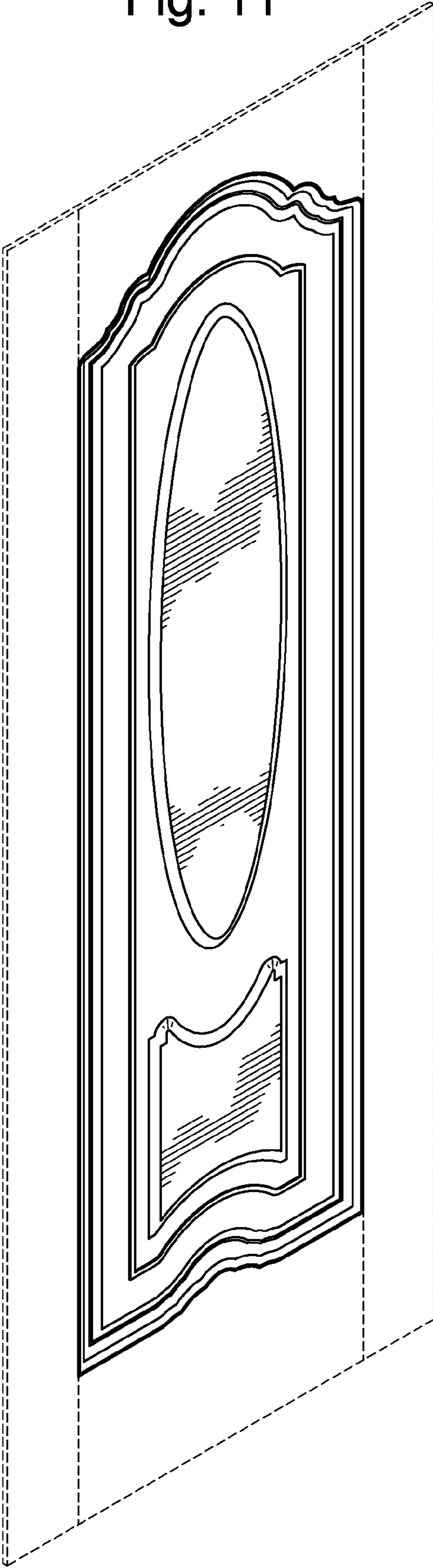

Fig. 11



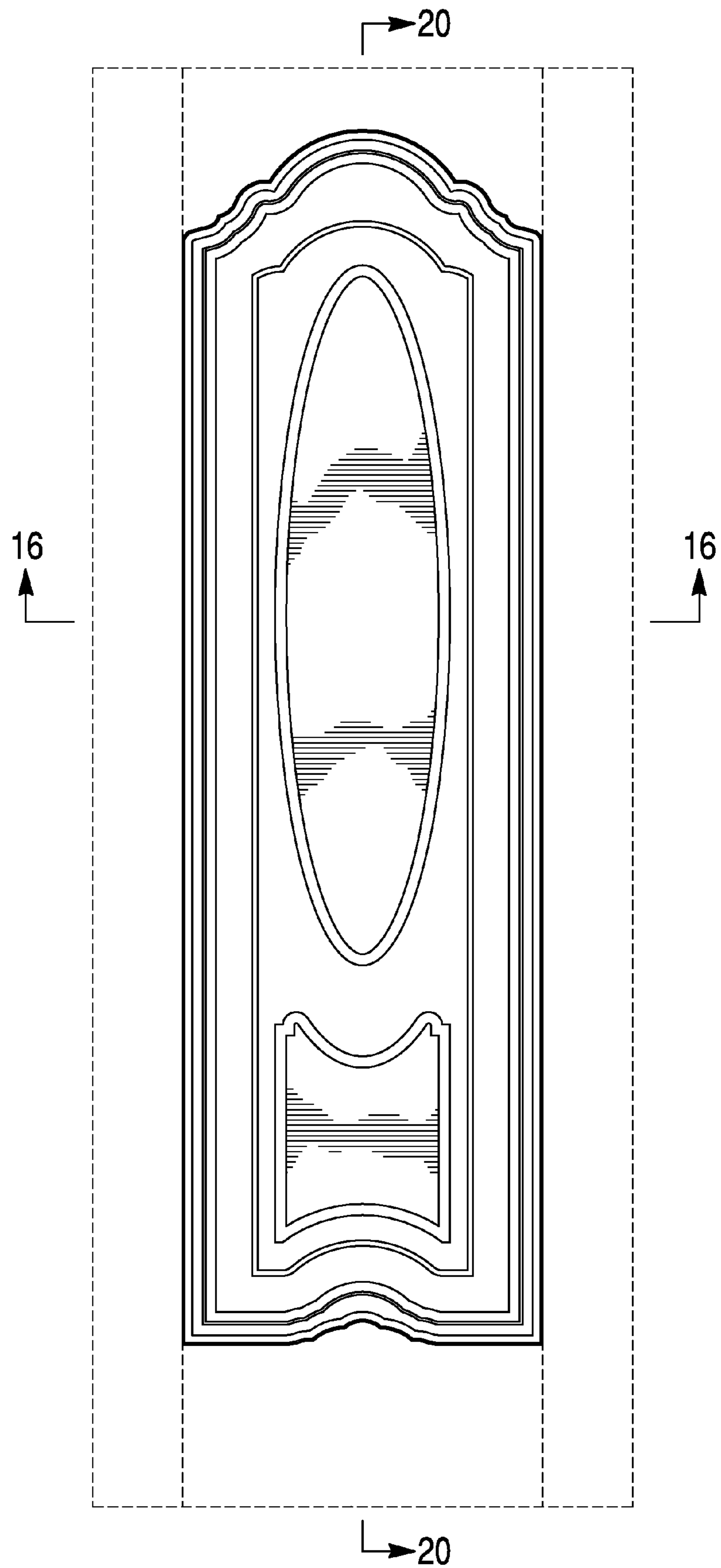

Fig. 12

Fig. 13

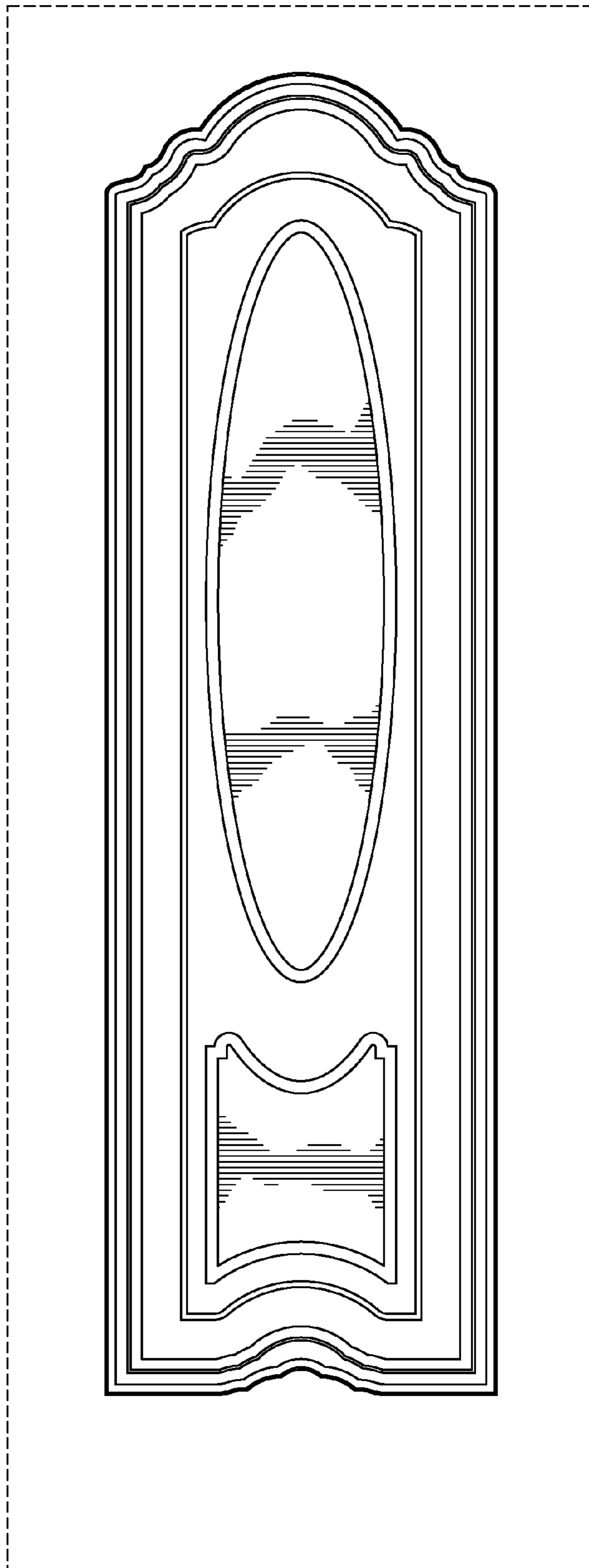

Fig. 14



Fig. 15



Fig. 16



Fig. 17

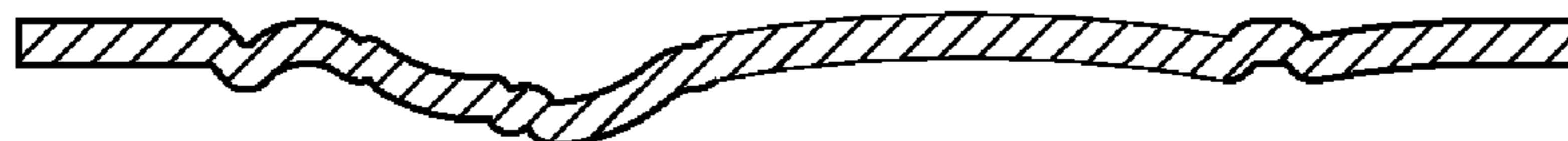

Fig. 18



Fig. 19



Fig. 20

