



US00D634850S

(12) **United States Design Patent**
Kibele et al.

(10) **Patent No.:** **US D634,850 S**

(45) **Date of Patent:** **** *Mar. 22, 2011**

(54) **COVERING MATERIAL**

(75) Inventors: **Ralf Kibele**, Bruckmuhl (DE); **Karin Klokkers**, Reichersbeuern (DE); **Hans-Jürgen Schlüter**, Bad Tolz (DE)

(73) Assignee: **Hexal AG**, Holzkirchen (DE)

(*) Notice: This patent is subject to a terminal disclaimer.

(**) Term: **14 Years**

(21) Appl. No.: **29/286,050**

(22) Filed: **Apr. 20, 2007**

(30) **Foreign Application Priority Data**

Oct. 20, 2006 (DE) 4 06 05 480

(51) **LOC (9) Cl.** **24-04**

(52) **U.S. Cl.** **D24/189**

(58) **Field of Classification Search** D24/188-189;
604/307, 375; 602/41-45, 48, 54-56, 57-59;
424/630-638; 428/40.1, 43, 57, 139, 343,
428/352; 128/894; D20/11

See application file for complete search history.

(56) **References Cited**

U.S. PATENT DOCUMENTS

4,649,909 A * 3/1987 Thompson 602/42
5,056,510 A * 10/1991 Gilman 602/52
D389,581 S * 1/1998 Fein D24/189
D410,087 S * 5/1999 Dunshee et al. D24/189
D458,687 S * 6/2002 Dale et al. D24/189

(Continued)

FOREIGN PATENT DOCUMENTS

JP 56-170231 U 12/1981

Primary Examiner — Holly H Baynham

Assistant Examiner — Michelle E Wilson

(74) *Attorney, Agent, or Firm* — Peter F. Corless; Christine C. O'Day; Edwards Angell Palmer & Dodge LLP

(57) **CLAIM**

The ornamental design for a covering material, as shown and described.

DESCRIPTION

FIG. 1 is a front view of the covering material in a first embodiment, showing our new design;

FIG. 2 is a front view of the covering material in a second embodiment thereof;

FIG. 3 is a front view of the covering material in a third embodiment thereof;

FIG. 4 is a front view of the covering material in a fourth embodiment thereof;

FIG. 5 is a front view of the covering material in a fifth embodiment thereof;

FIG. 6 is a front view of the covering material in a sixth embodiment thereof;

FIG. 7 is a front view of the covering material in a seventh embodiment thereof;

FIG. 8 is a front view of the covering material in an eighth embodiment thereof;

FIG. 9 is a front view of the covering material in a ninth embodiment thereof;

FIG. 10 is a front view of the covering material in a tenth embodiment thereof;

FIG. 11 is a front view of the covering material in an eleventh embodiment thereof;

FIG. 12 is a front view of the covering material in a twelfth embodiment thereof;

FIG. 13 is a front view of the covering material in a thirteenth embodiment thereof; and,

FIG. 14 is a front view of the covering material in a fourteenth embodiment thereof.

The broken lines shown on the covering material are included for the purpose of illustrating a cutting line or removable film and forms part of the claimed design.

The covering material can in particular embodiments be a transdermal therapeutic system (e.g. transdermal drug delivery system), comprising e.g. a face (face sheet/top layer) suitably with imprint including a line, which can be continuous or dashed, which imprint can be suitably provided e.g. by a removable film.

1 Claim, 7 Drawing Sheets

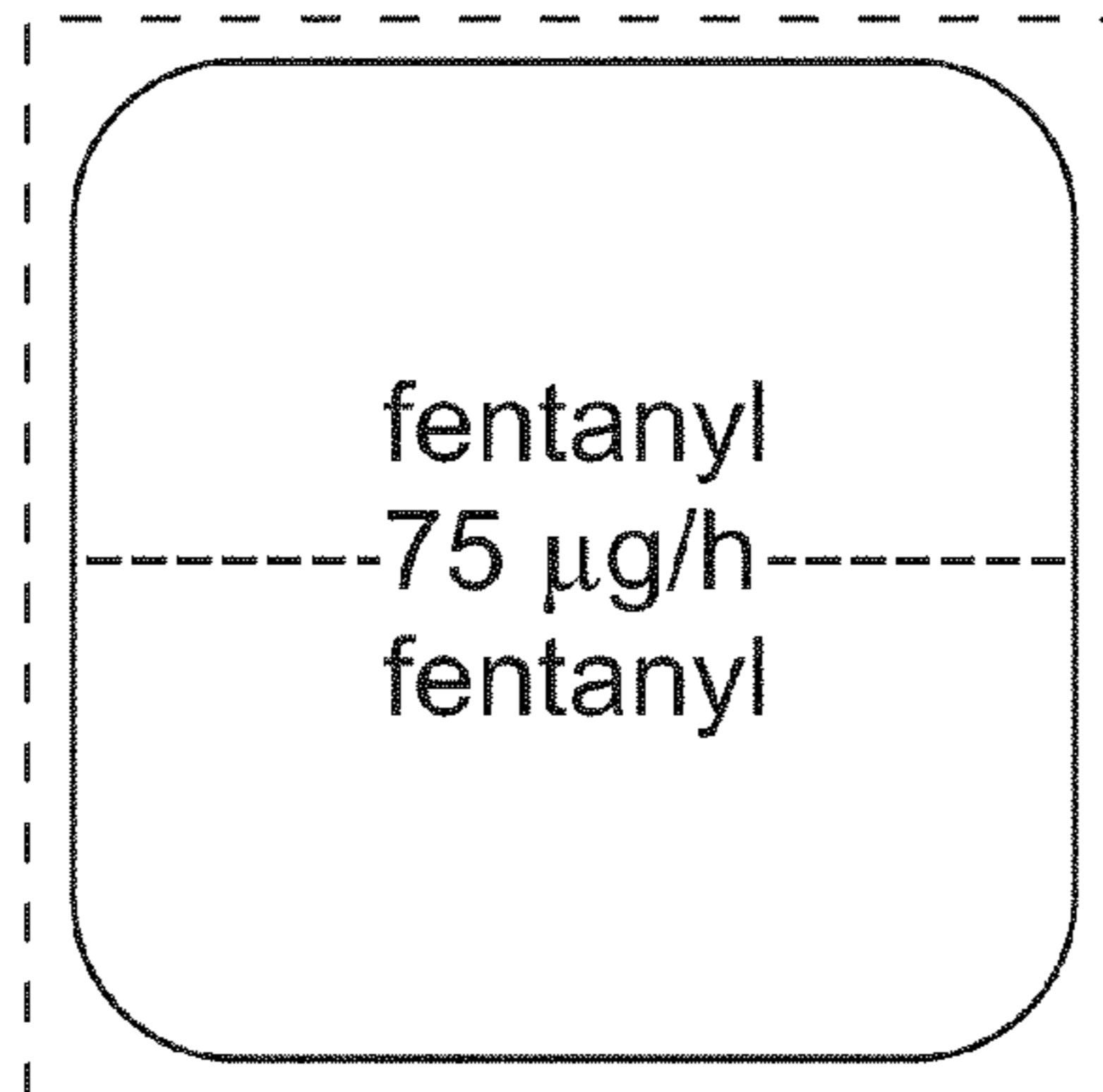

US D634,850 S

Page 2

U.S. PATENT DOCUMENTS

| | | | | | | | |
|--------------|--------|---------------------|---------|--------------|--------|-----------------------|---------|
| D477,086 S * | 7/2003 | Tsuruda et al. | D24/189 | D537,947 S * | 3/2007 | Miyachika et al. | D24/189 |
| D492,416 S * | 6/2004 | Horhota et al. | D24/189 | D545,440 S * | 6/2007 | Jensen | D24/189 |
| D495,419 S * | 8/2004 | Dunshee | D24/189 | D545,441 S * | 6/2007 | Miyachika et al. | D24/189 |
| D513,639 S * | 1/2006 | Saim et al. | D24/189 | D573,260 S * | 7/2008 | Dunshee | D24/189 |
| D515,701 S * | 2/2006 | Horhota et al. | D24/189 | D575,874 S * | 8/2008 | Ormsby | D24/189 |
| D535,032 S * | 1/2007 | Bendjy | D24/189 | | | | |

* cited by examiner

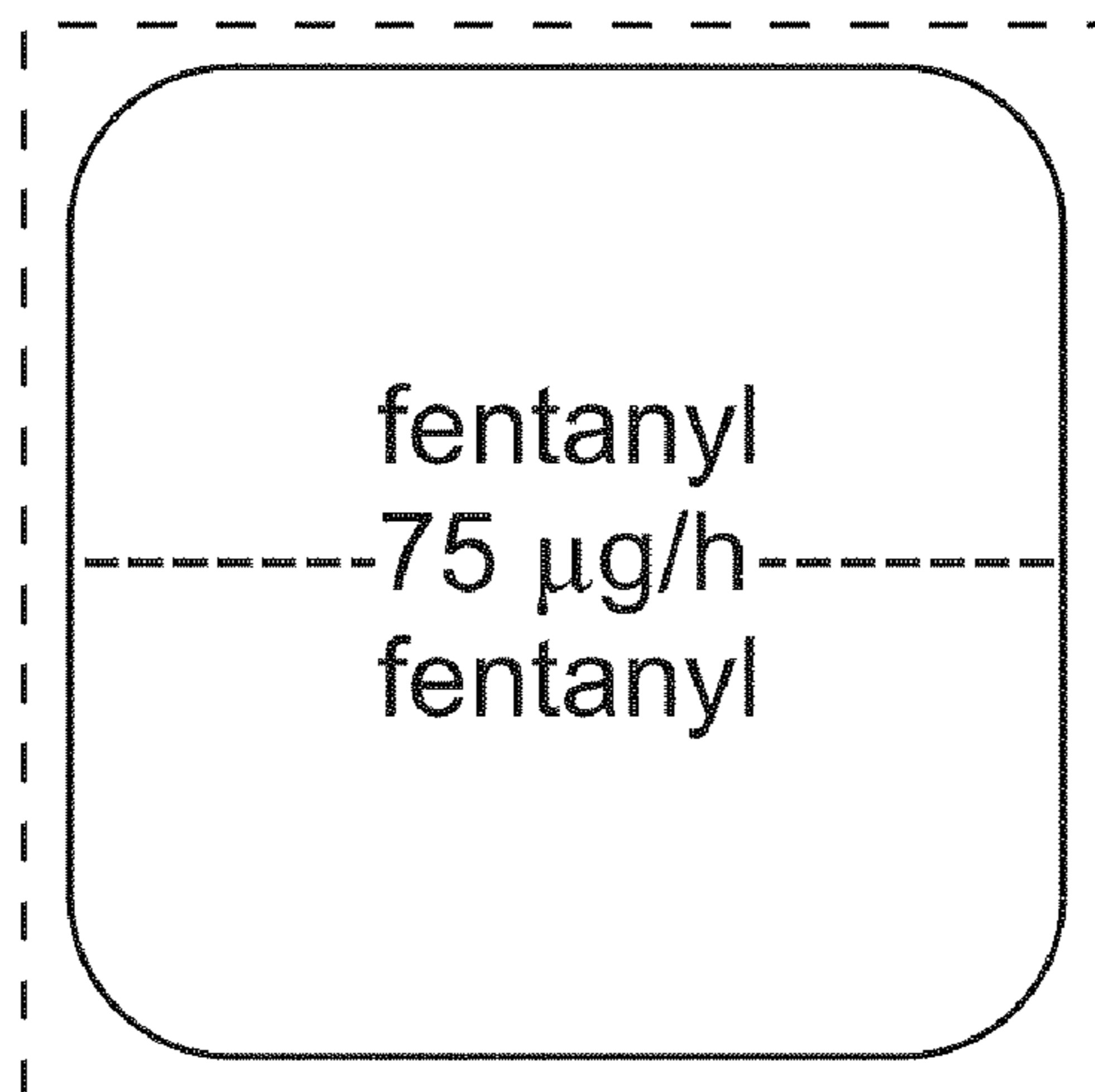

FIG. 1

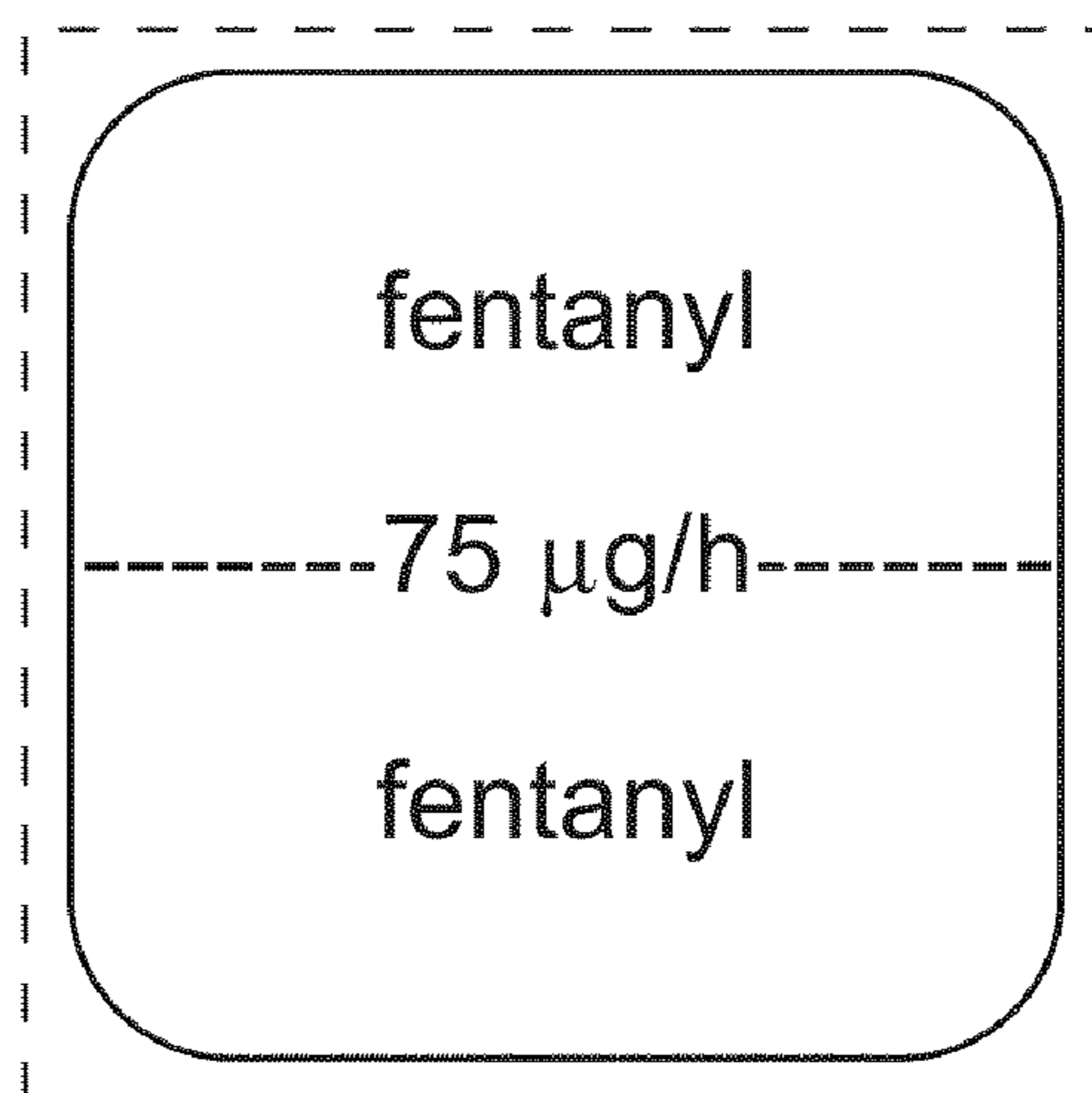

FIG. 2

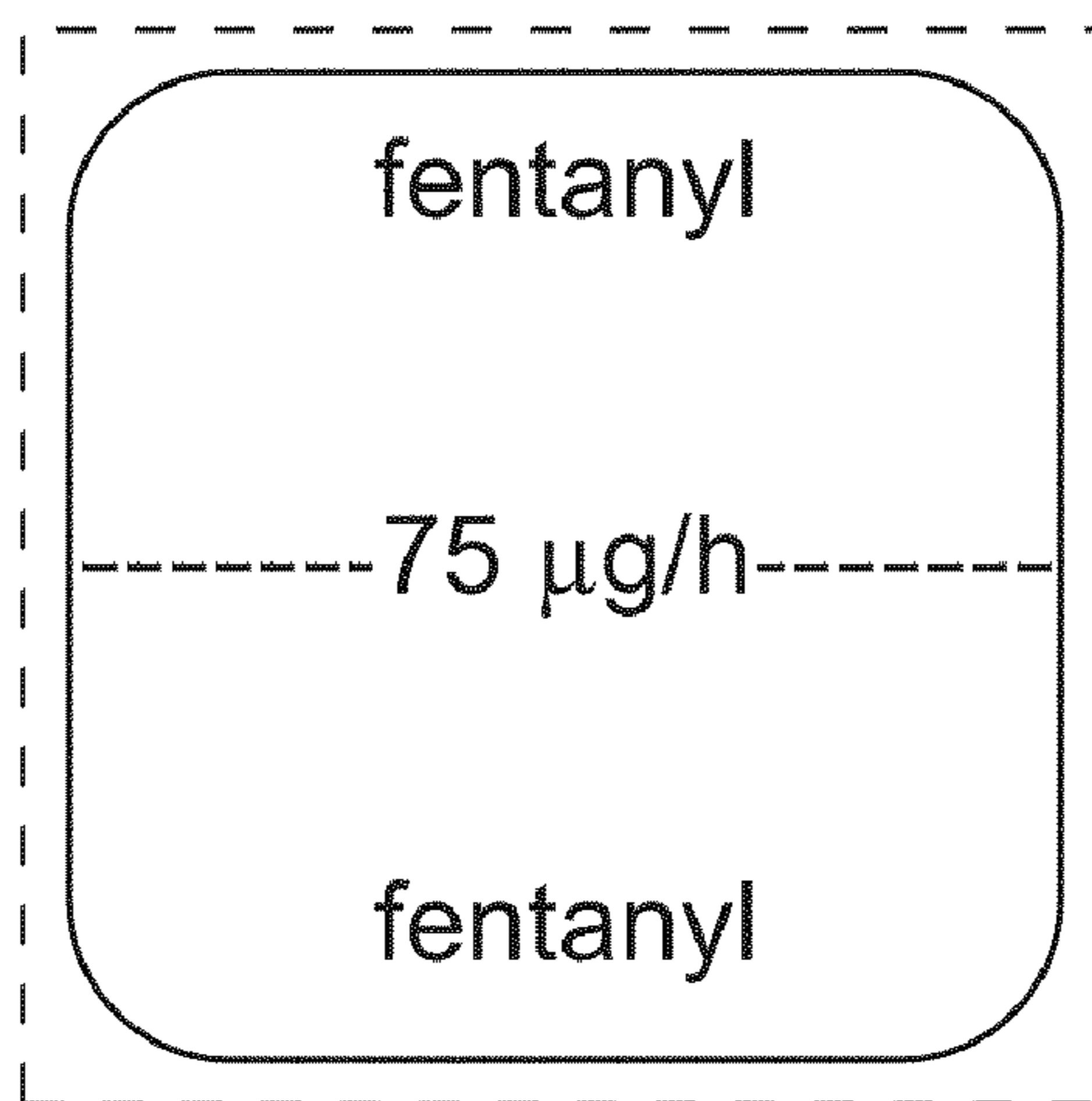

FIG. 3

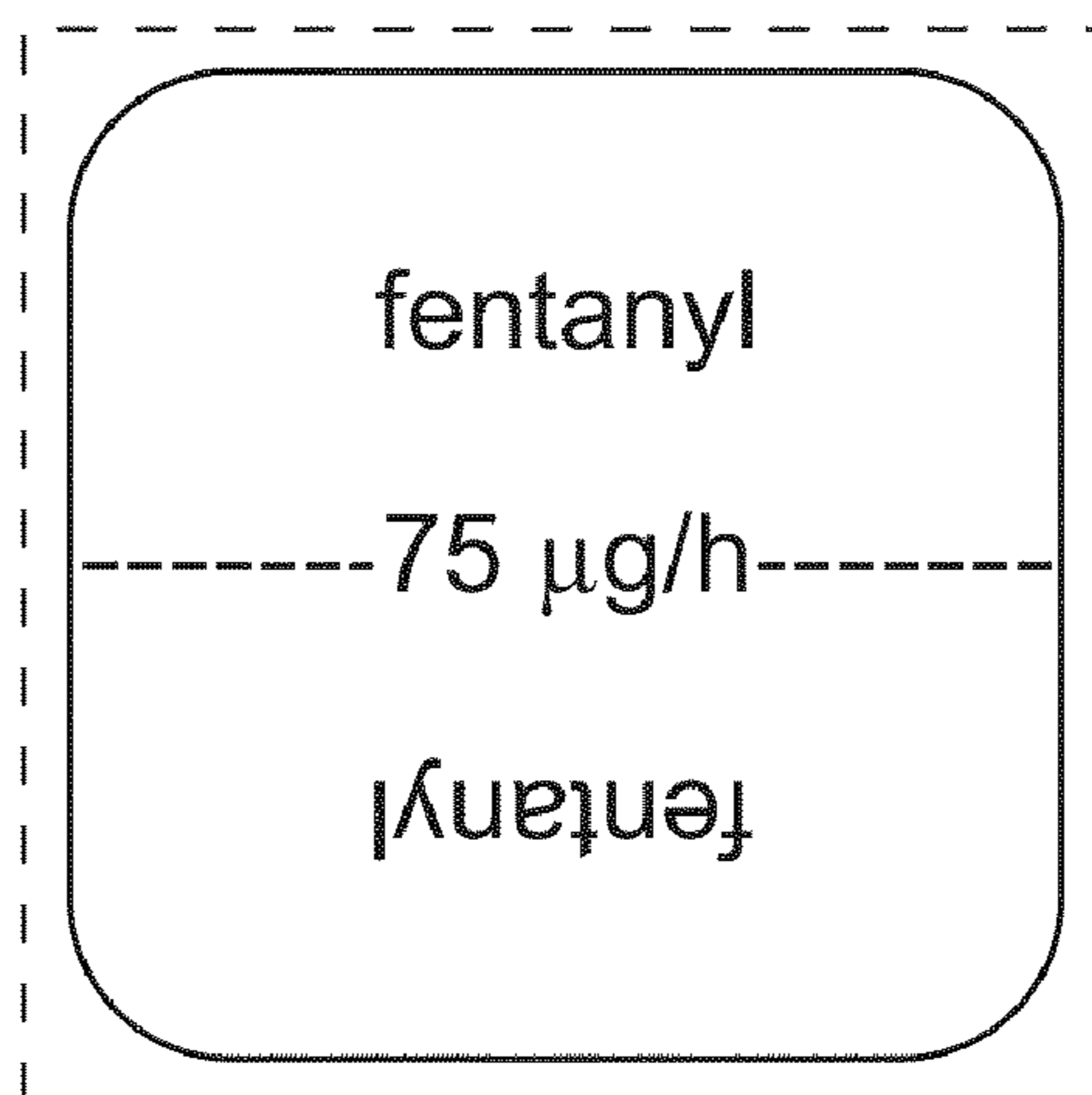

FIG. 4

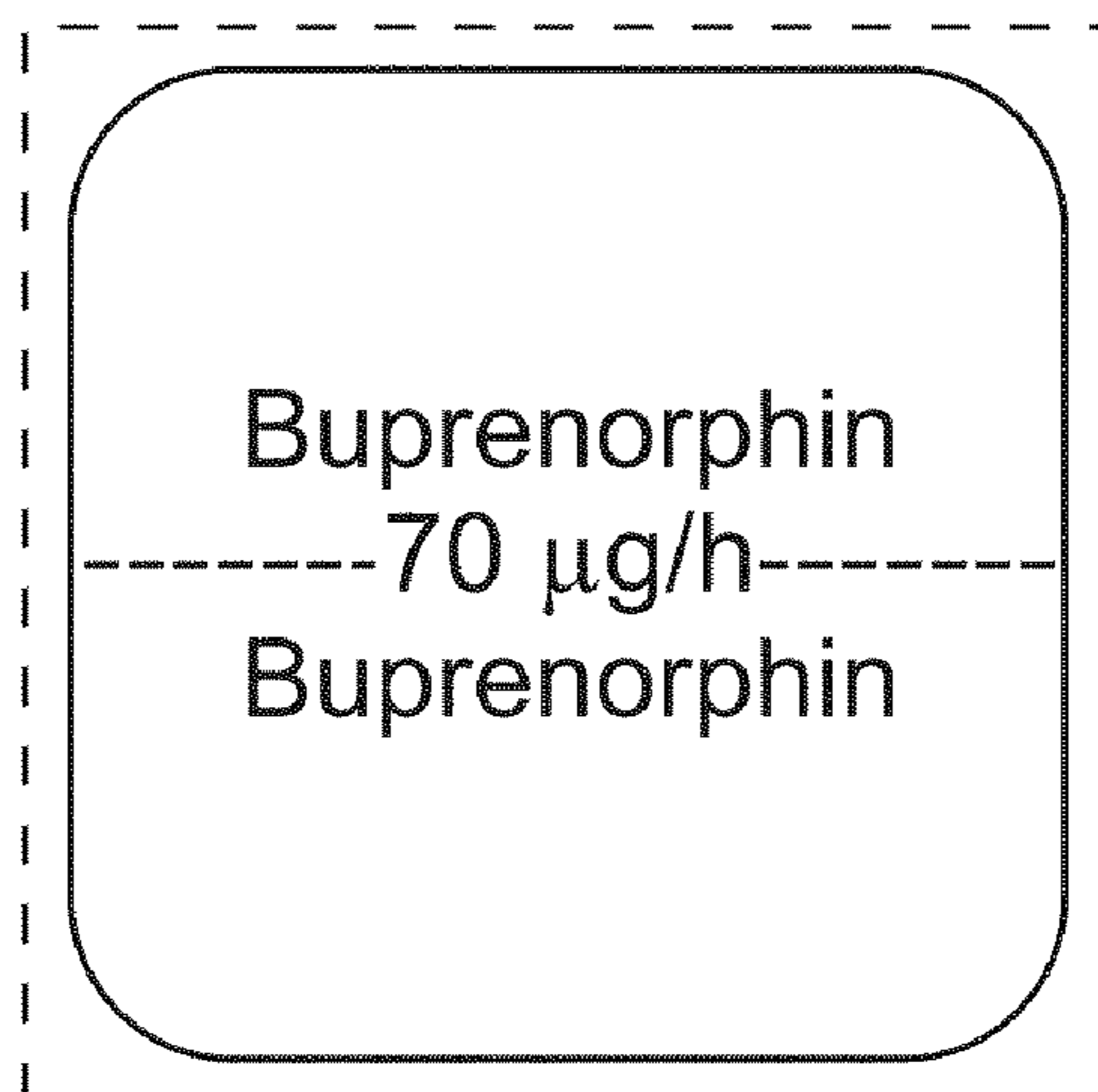

FIG. 5

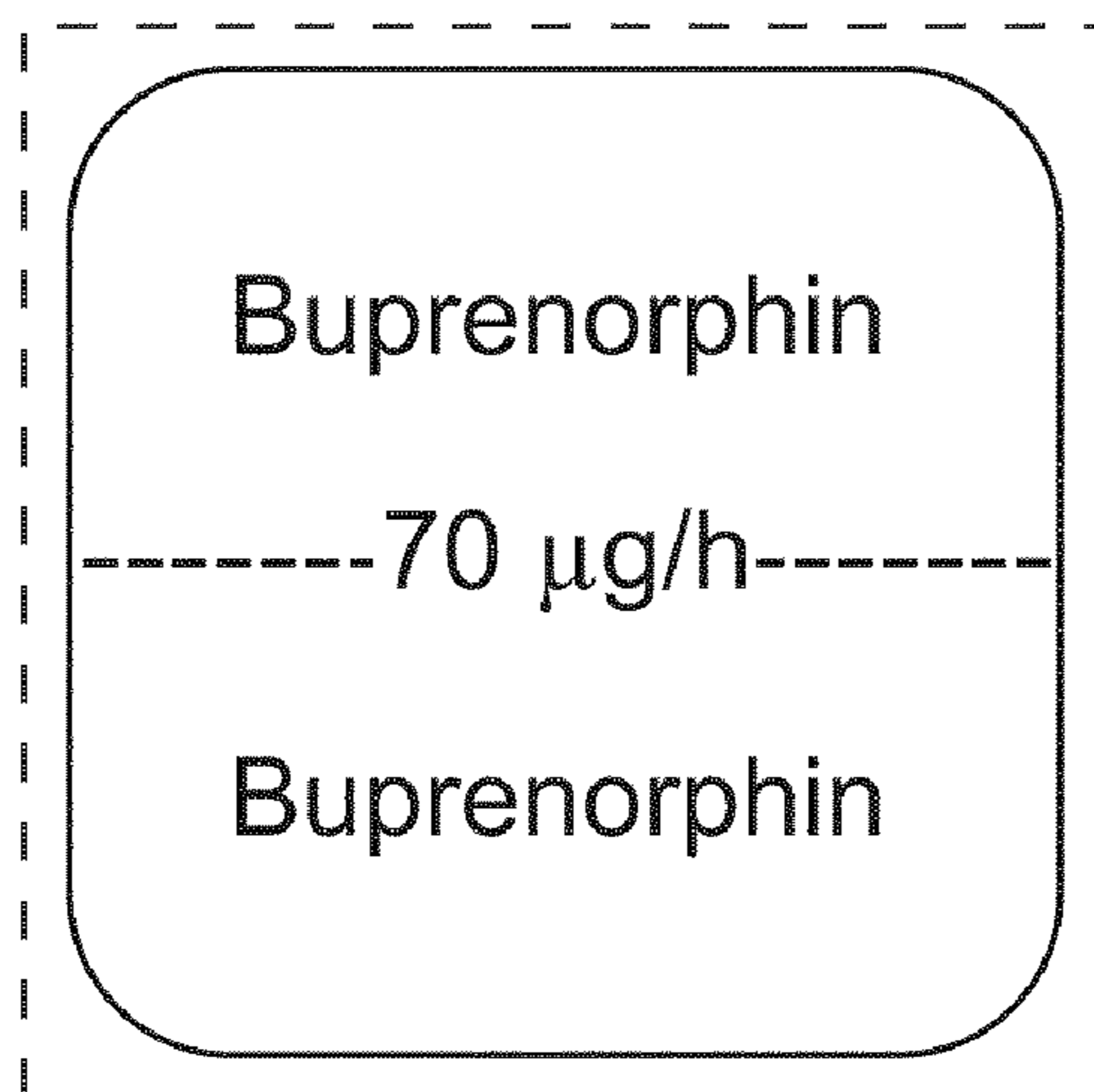

FIG. 6

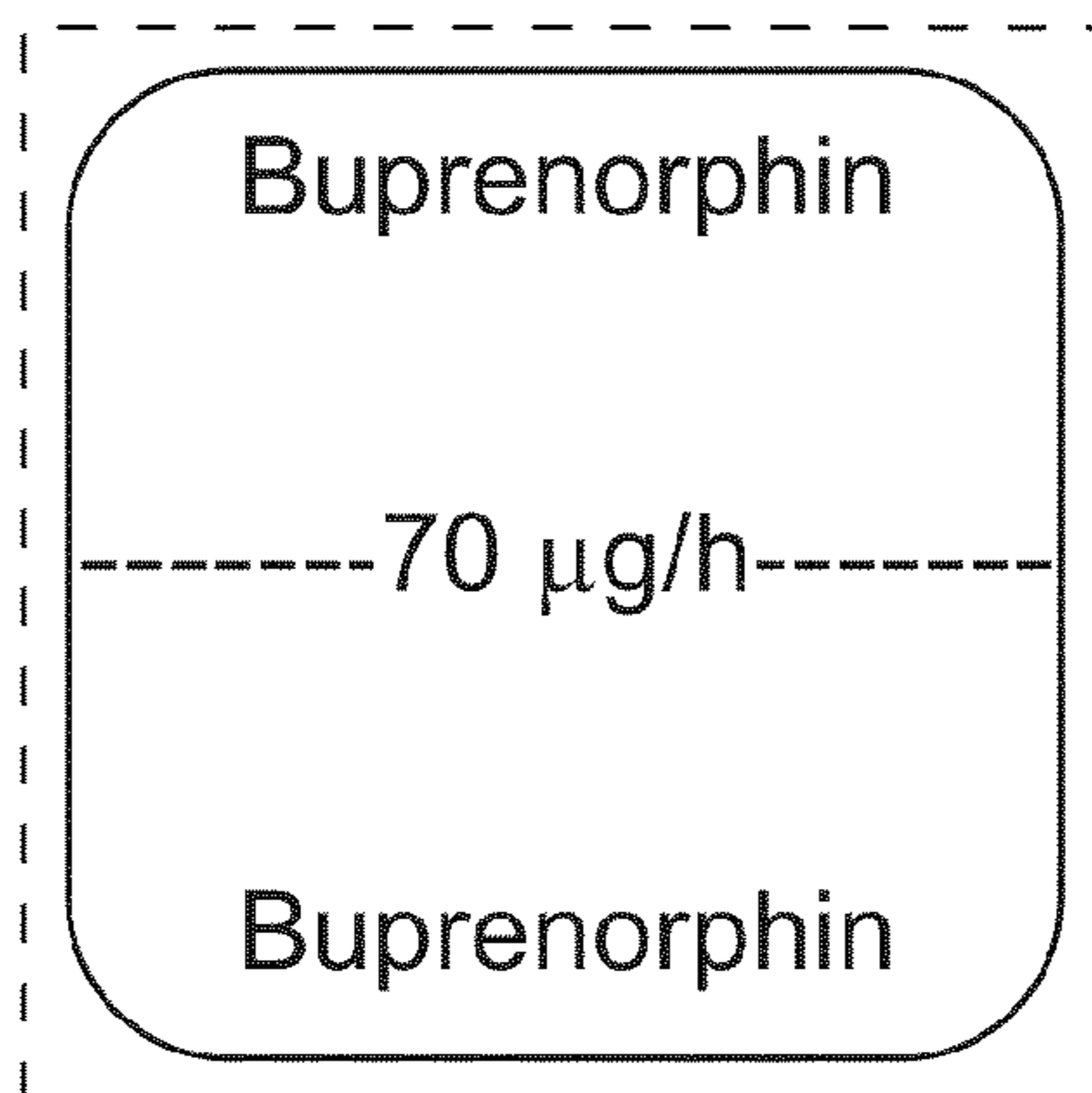

FIG. 7

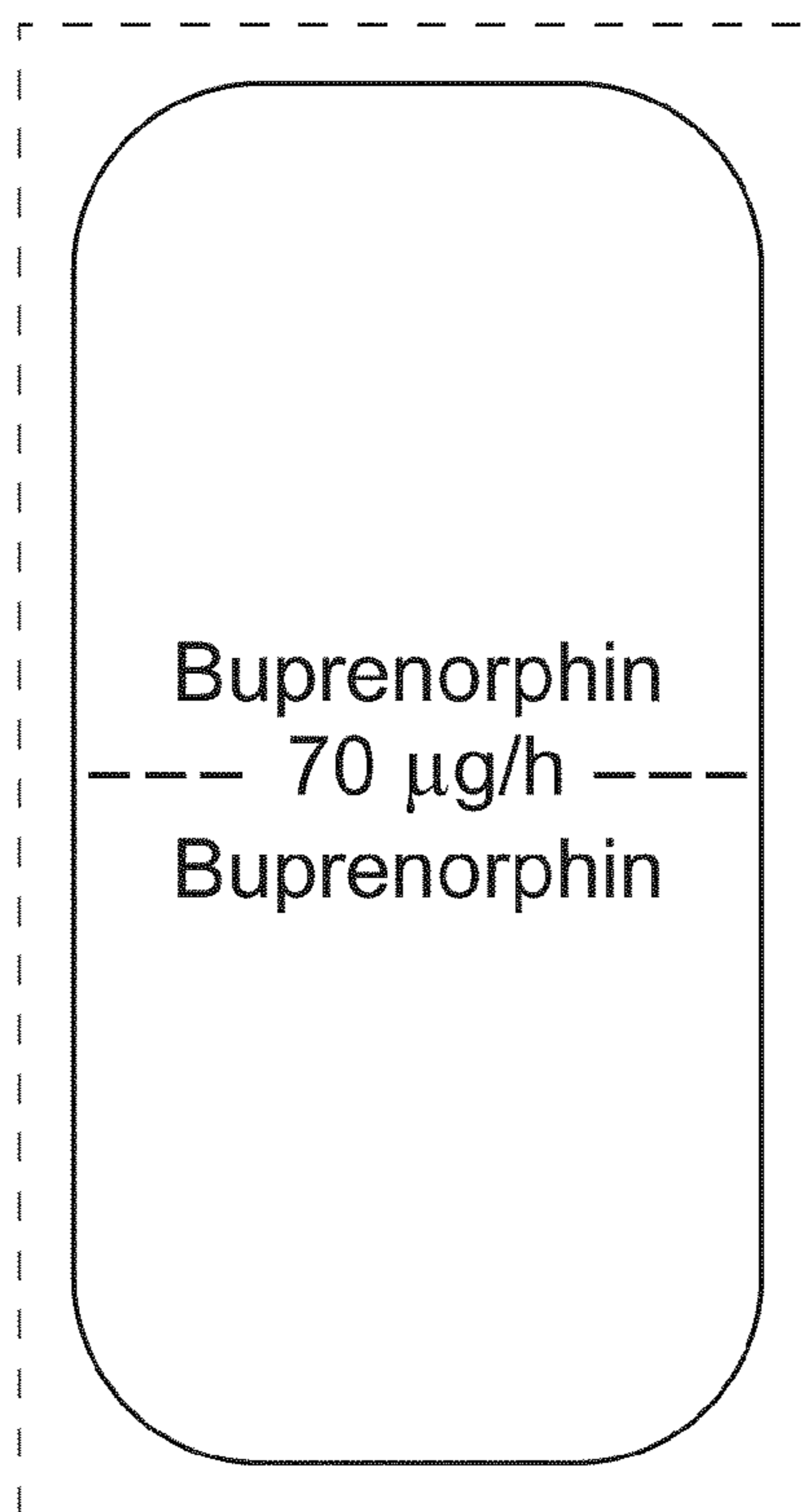

FIG. 8

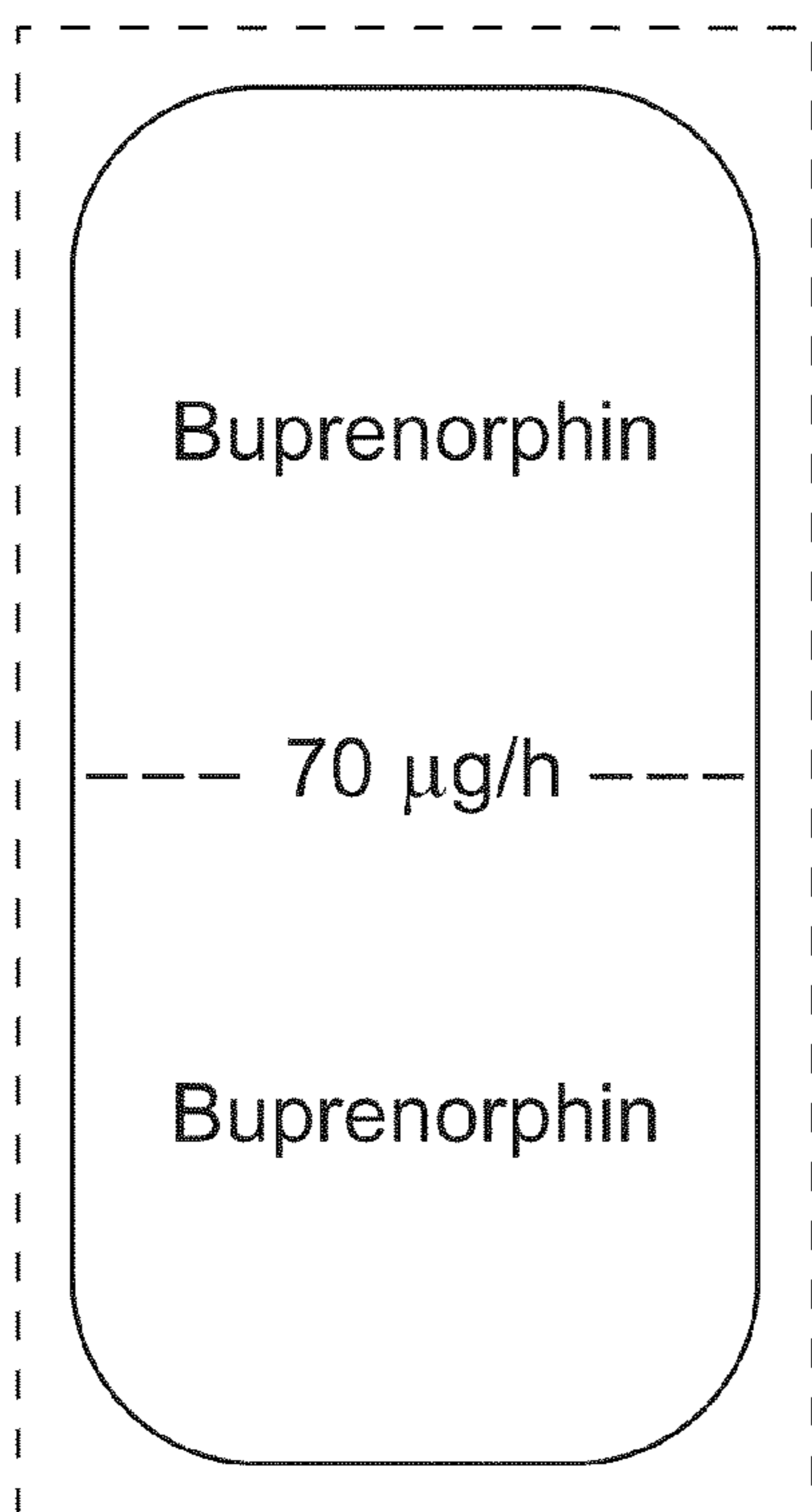

FIG. 9

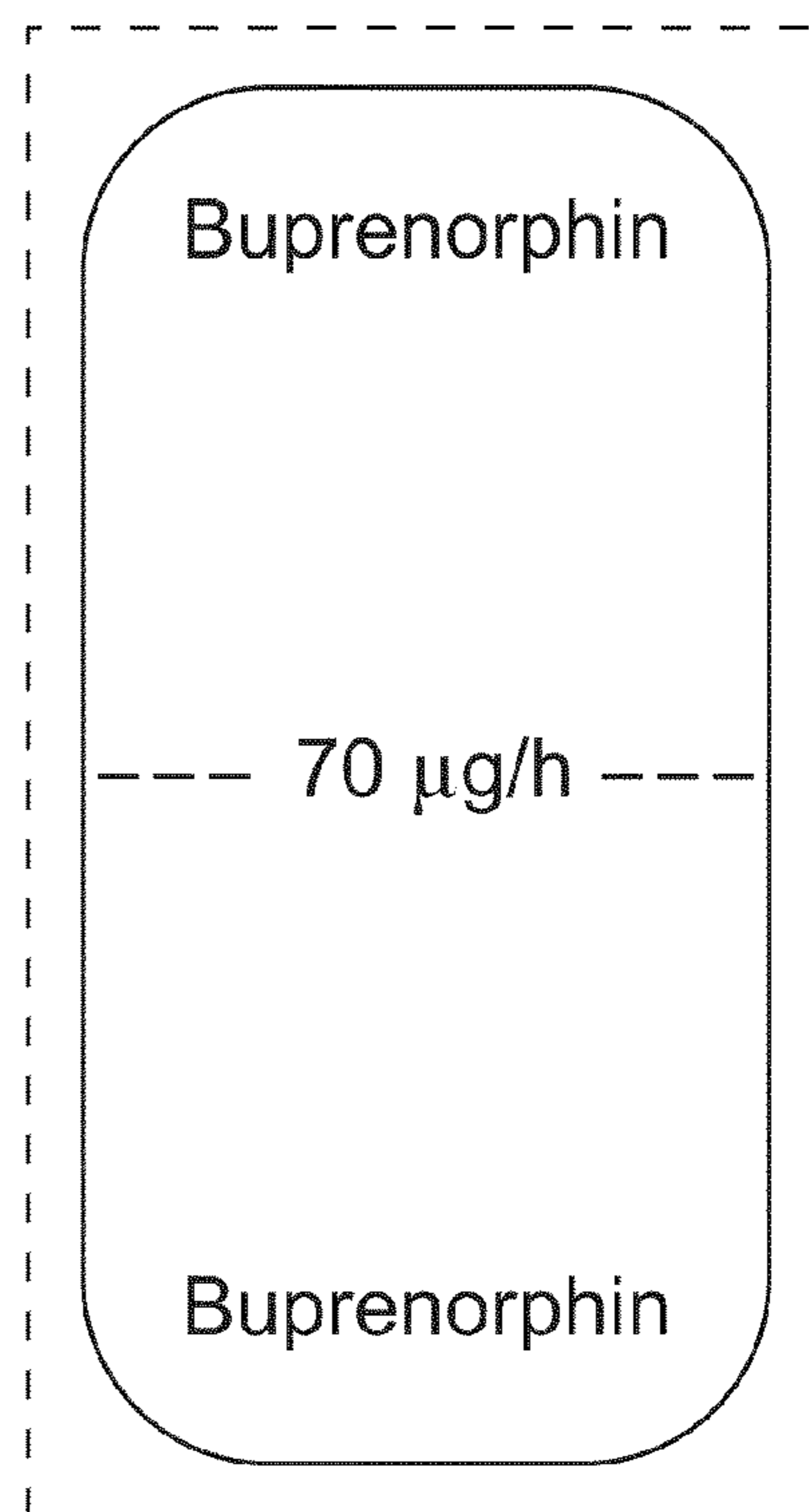

FIG. 10

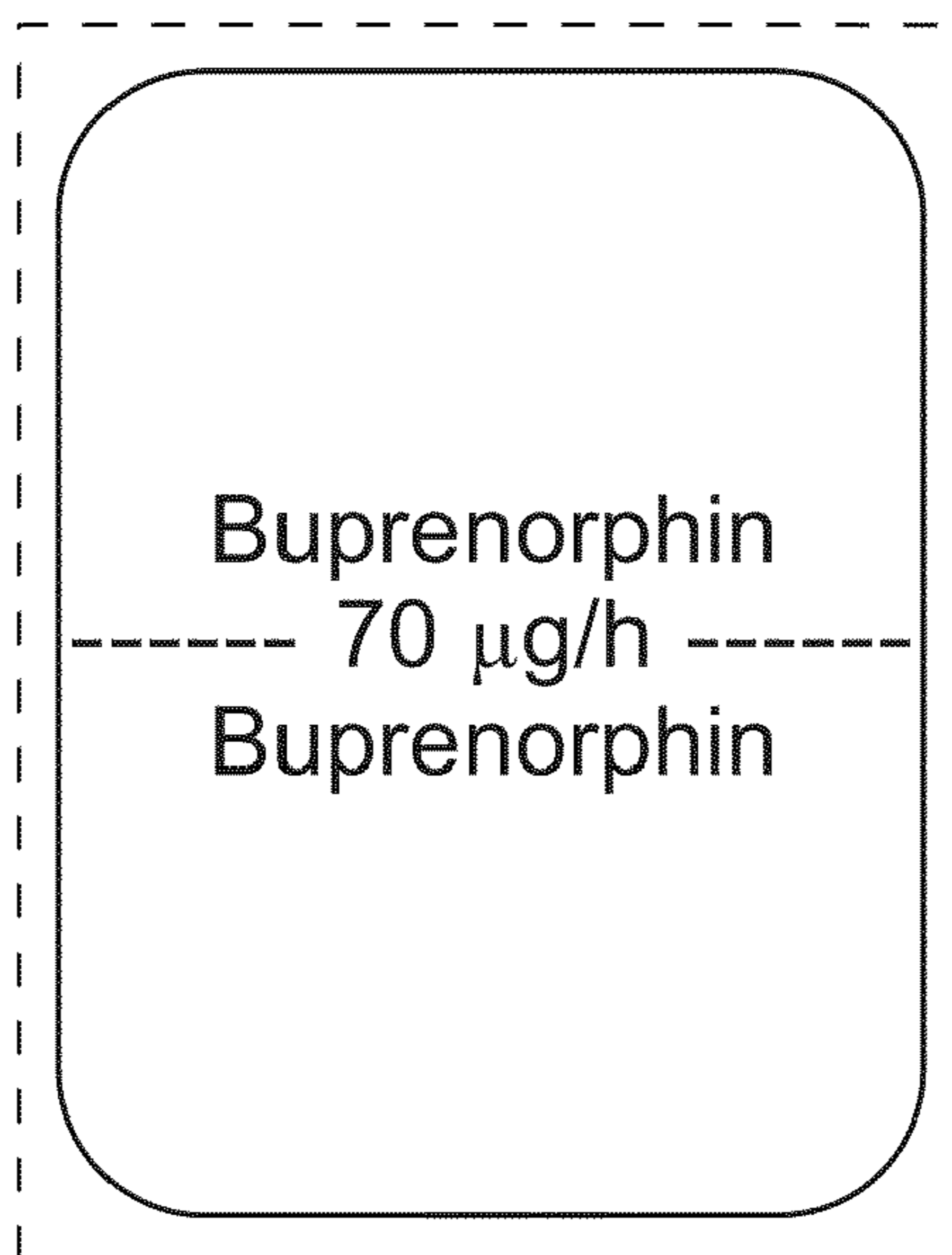

FIG. 11

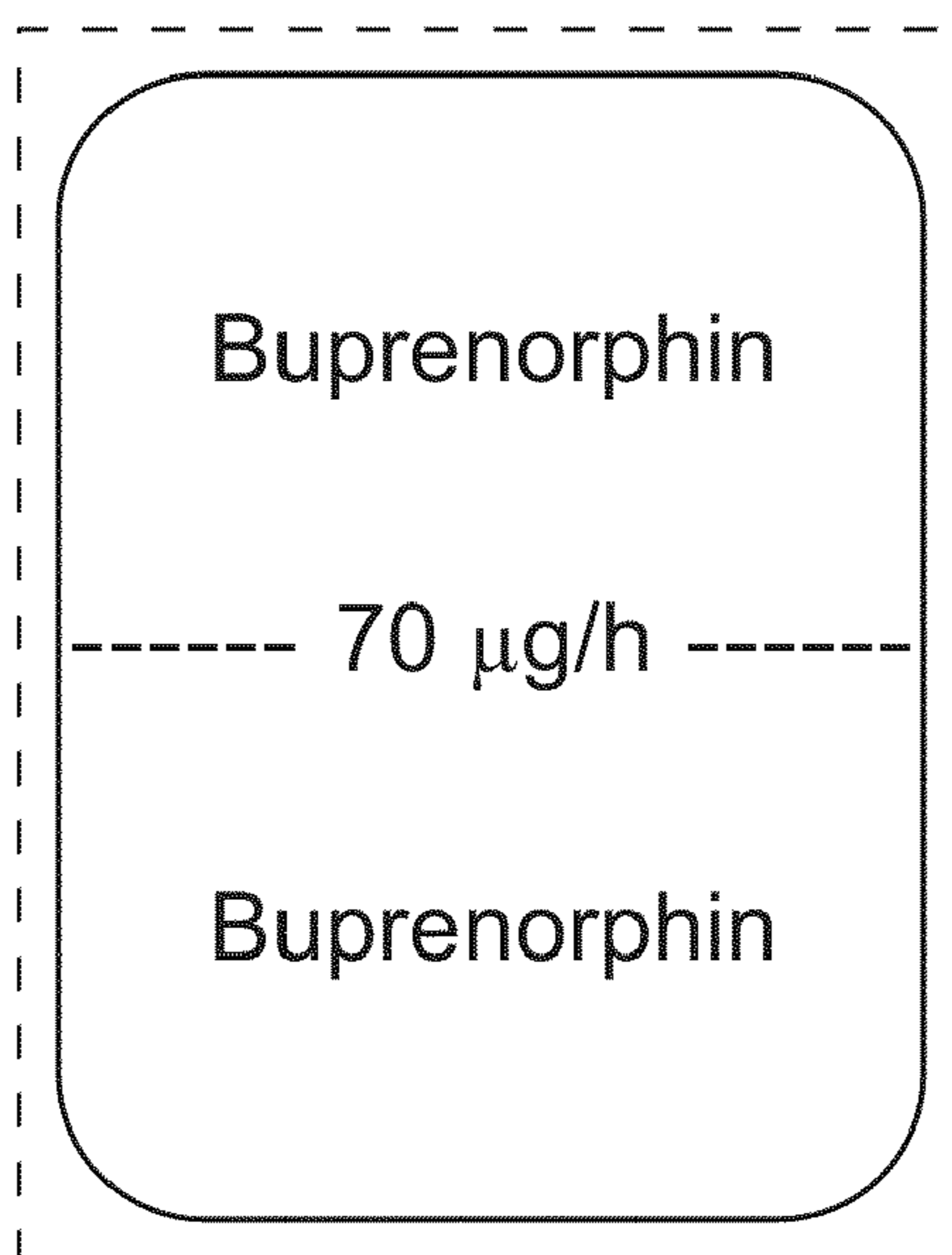

FIG. 12

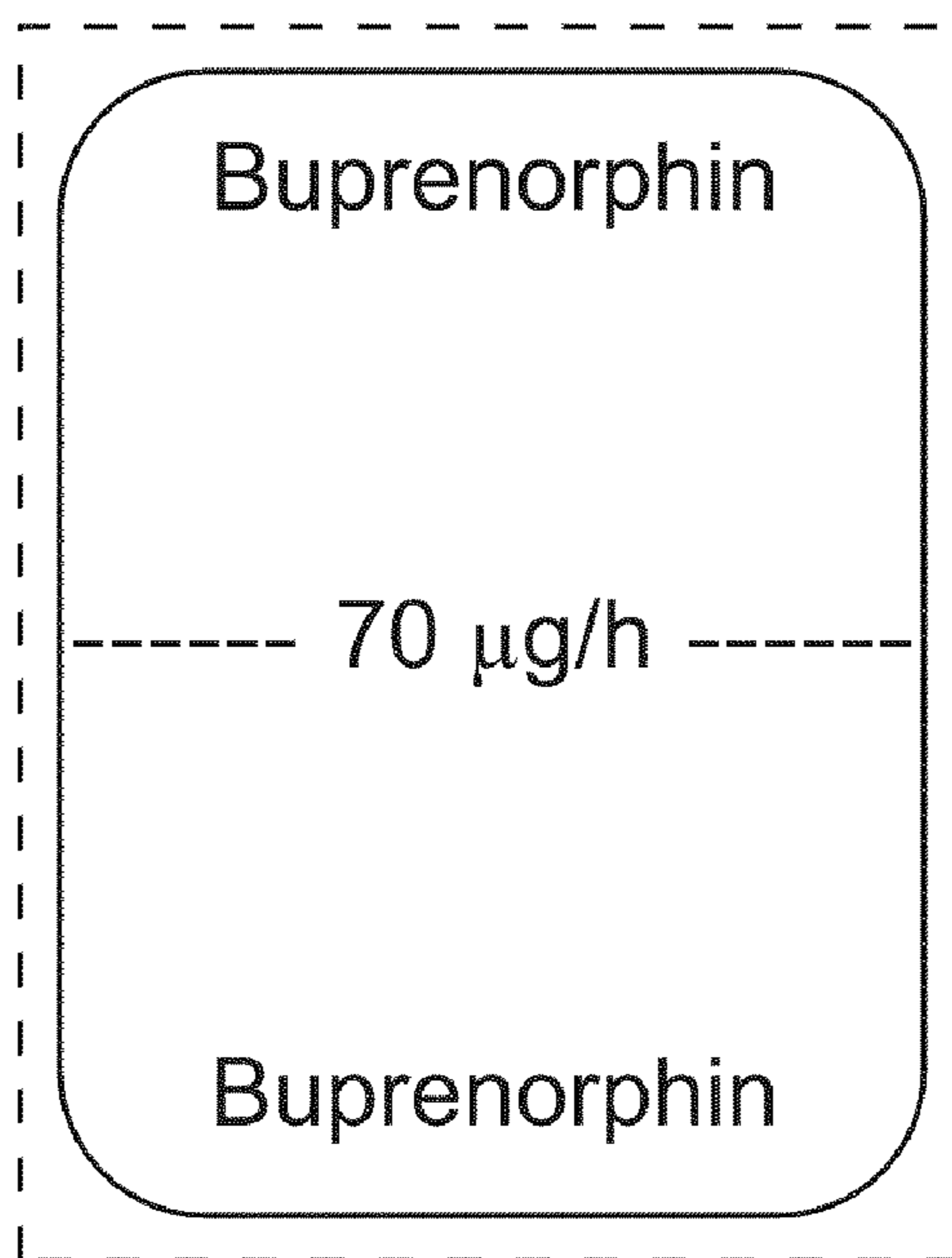

FIG. 13

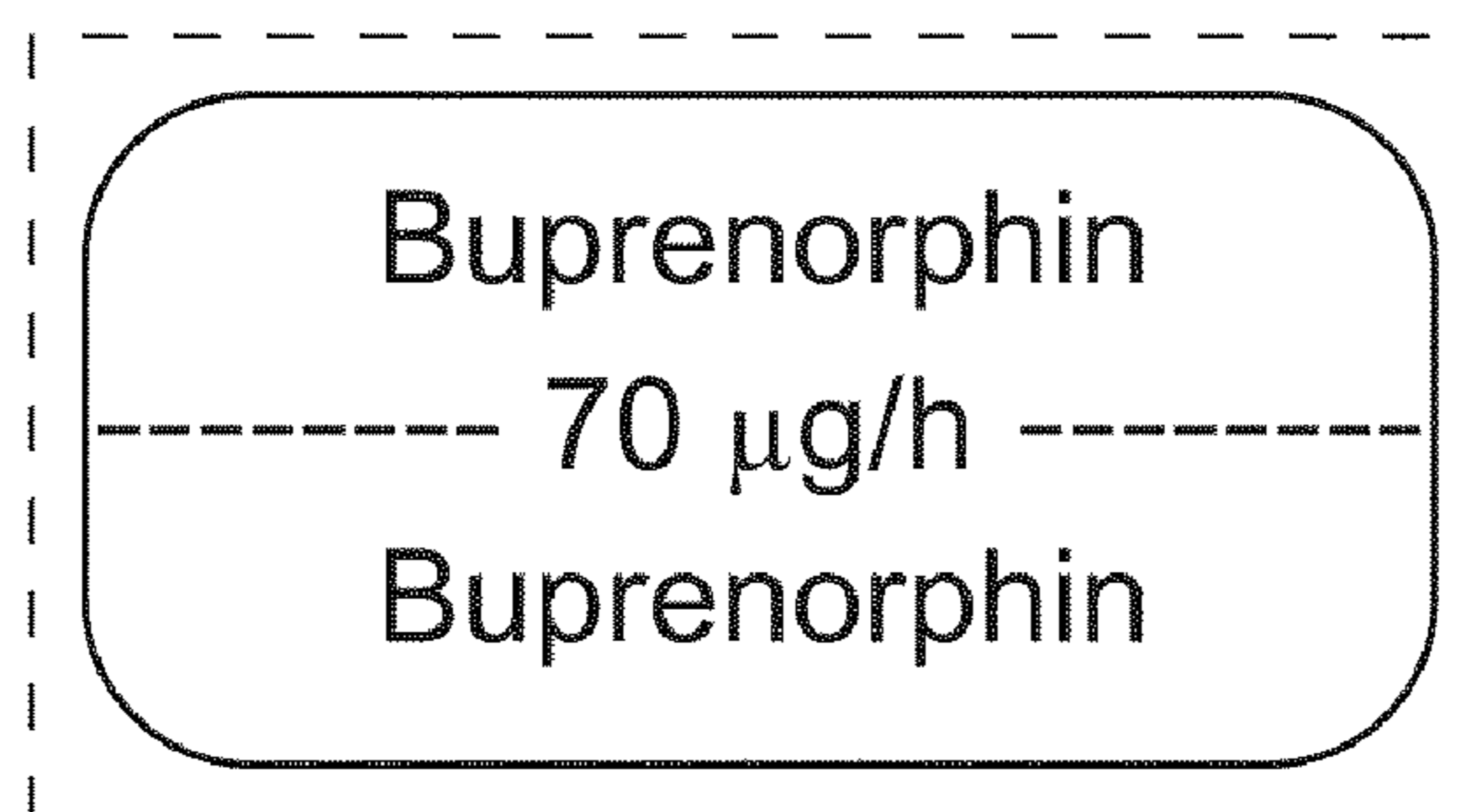

FIG. 14