

US00D634835S

(12) **United States Design Patent**
Lewis

(10) **Patent No.:** **US D634,835 S**
(45) **Date of Patent:** **** Mar. 22, 2011**

- (54) **BODY FOR A PORTABLE FAN**
- (75) Inventor: **William Lewis**, Denver, PA (US)
- (73) Assignee: **Lasko Holdings, Inc.**, Wilmington, DE (US)
- (**) Term: **14 Years**
- (21) Appl. No.: **29/370,970**
- (22) Filed: **Sep. 27, 2010**
- (51) **LOC (9) Cl.** **23-04**
- (52) **U.S. Cl.** **D23/378**
- (58) **Field of Classification Search** D23/378,
D23/332, 381, 335, 337, 336, 370, 382; 416/246 R,
416/247 R; 392/365, 367
See application file for complete search history.

- D581,038 S * 11/2008 Boswell D23/378
- D582,538 S * 12/2008 Catrino D23/378
- D603,036 S * 10/2009 Boswell D23/378
- * cited by examiner

Primary Examiner — Lisa P Lichtenstein
(74) *Attorney, Agent, or Firm* — Martin Fruitman

(57) **CLAIM**
The ornamental design of a body for a portable fan, as shown and described.

DESCRIPTION

FIG. 1 is a right side front perspective view of a body for a portable fan showing my new design;
FIG. 2 is a left side rear perspective view thereof;
FIG. 3 is a front elevation view thereof;
FIG. 4 is a right side elevation view thereof;
FIG. 5 is a left side elevation view thereof;
FIG. 6 is a rear elevation view thereof; and,
FIG. 7 is an enlarged top plan view thereof.
The broken line showing of front grill, rear grill and controls in FIGS. 1-7 is for illustrative purposes only and forms no part of the claimed design.

- (56) **References Cited**
- U.S. PATENT DOCUMENTS
- D514,687 S * 2/2006 Dooley D23/378
- D567,351 S * 4/2008 Shapiro D23/378
- D569,960 S * 5/2008 Lewis D23/378

1 Claim, 7 Drawing Sheets

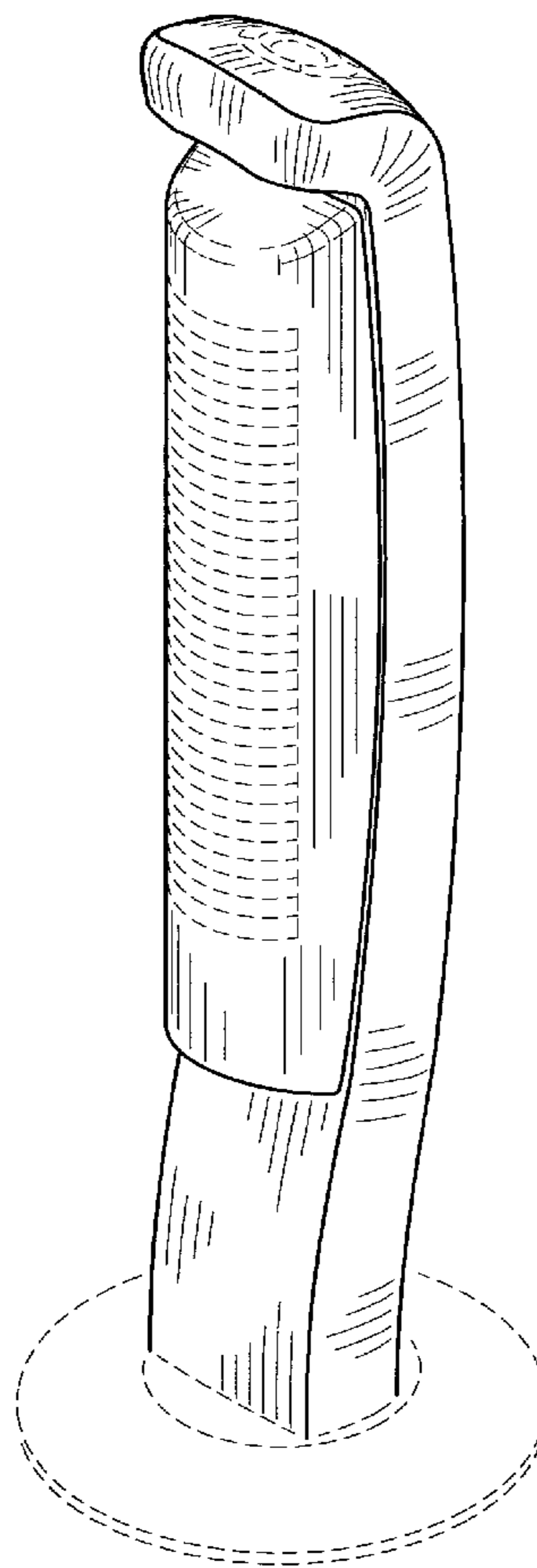
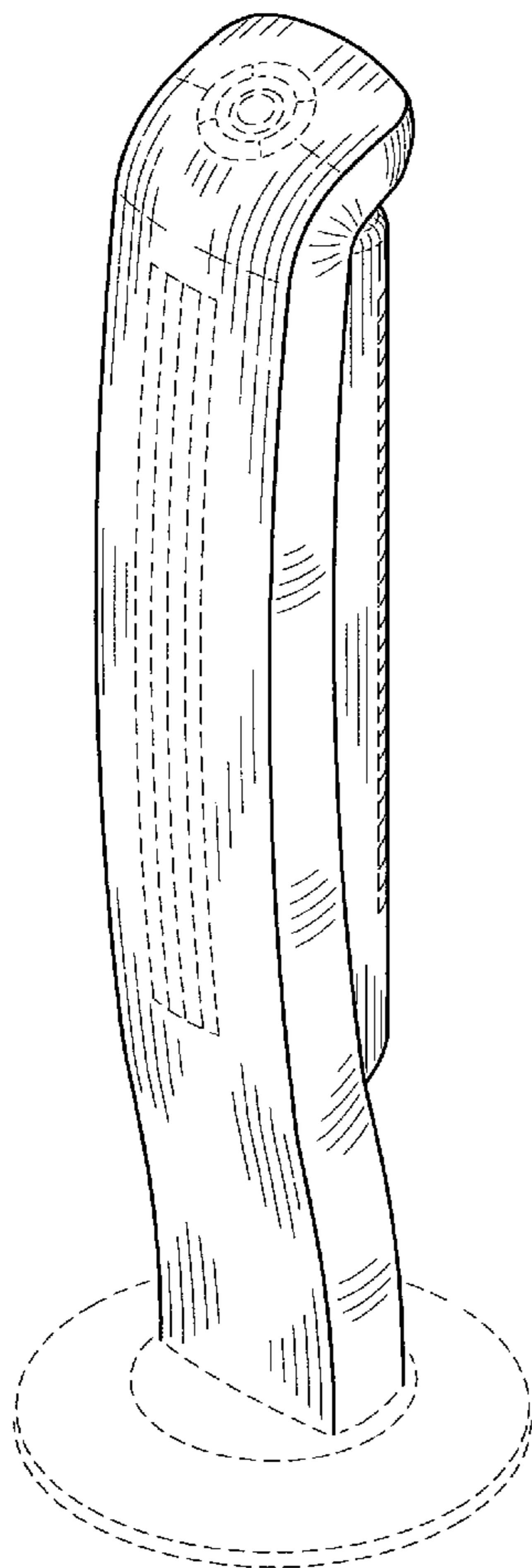

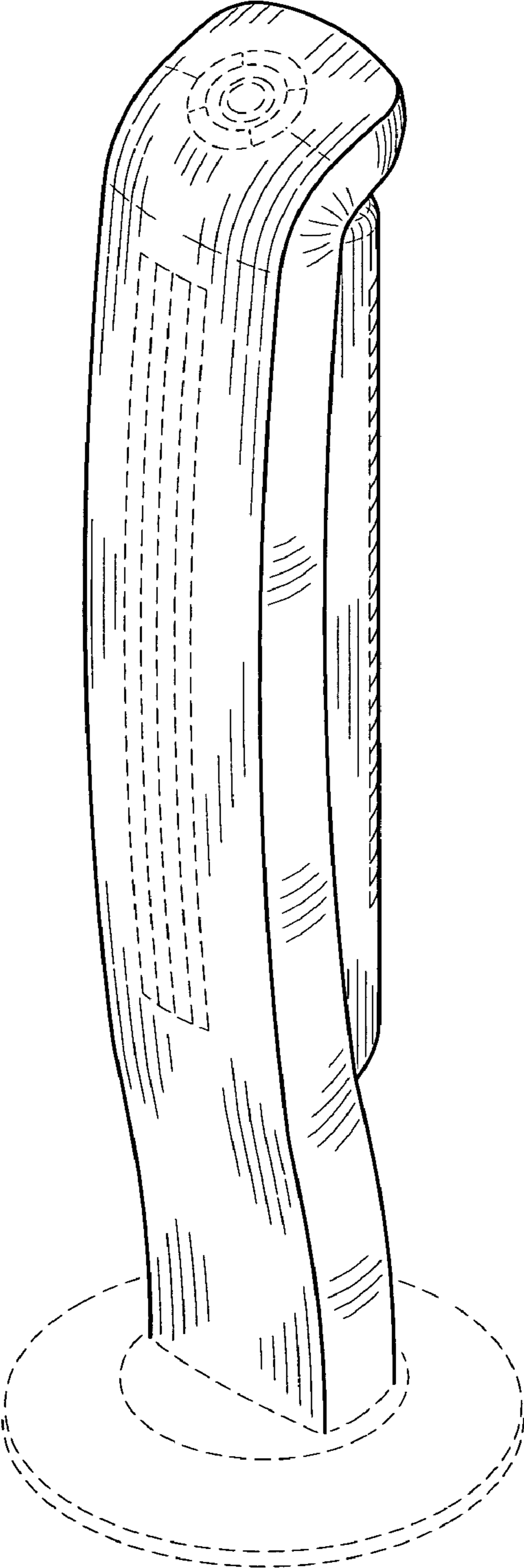

FIG. 1

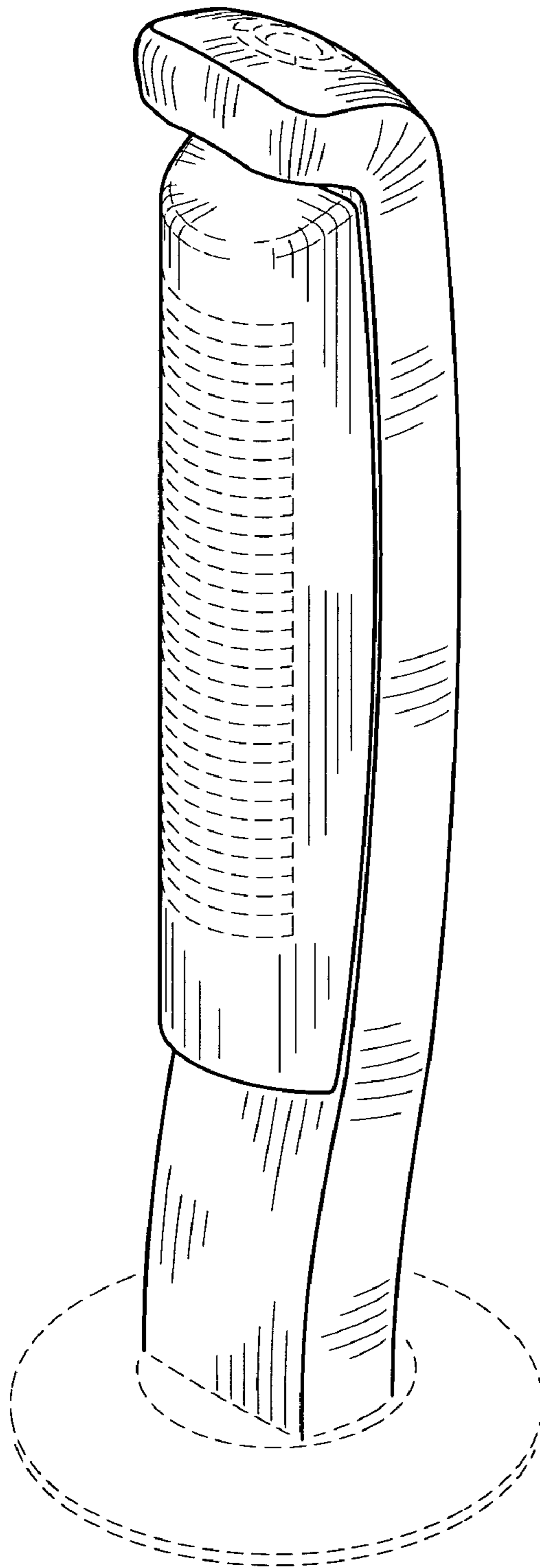

FIG. 2

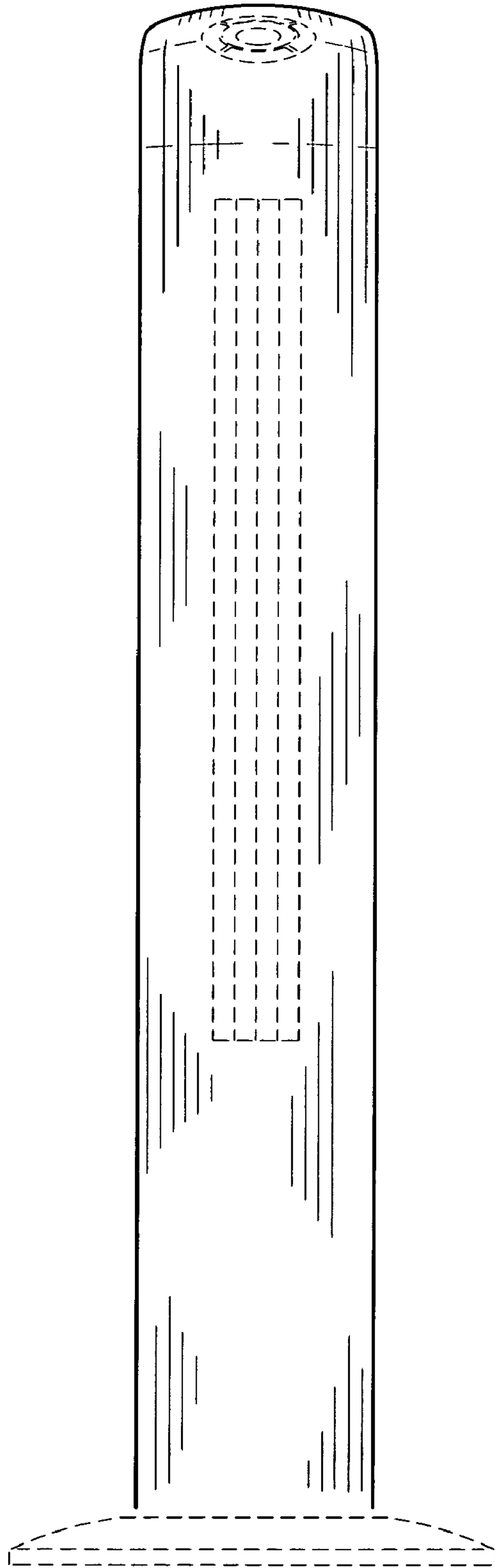

FIG. 3

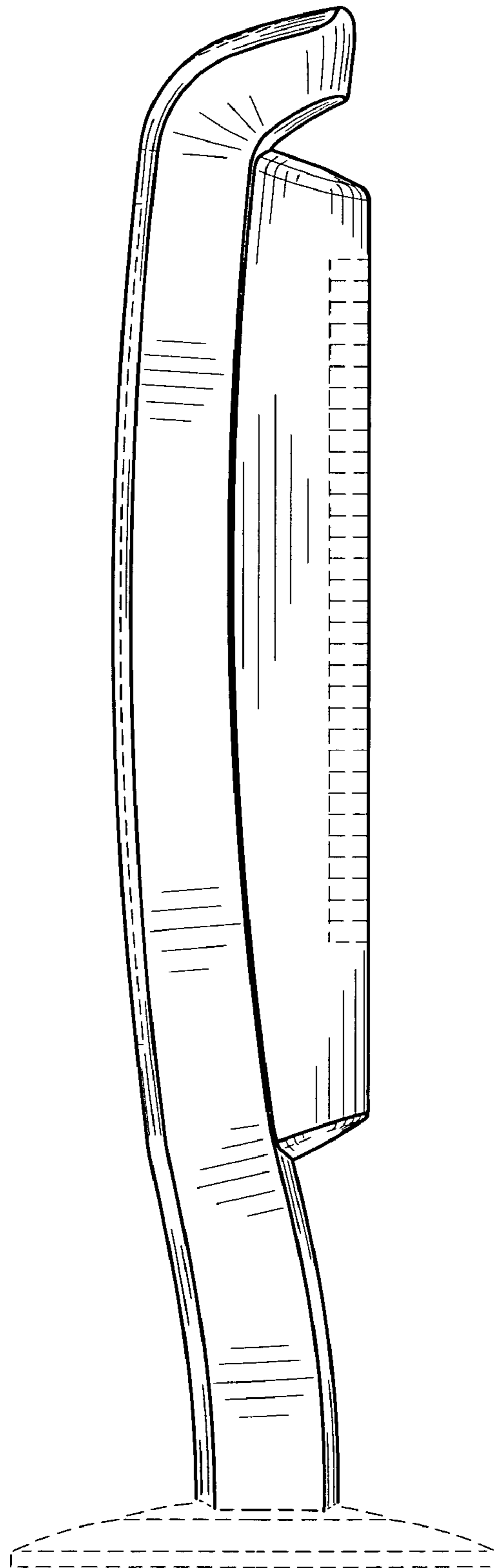

FIG. 4

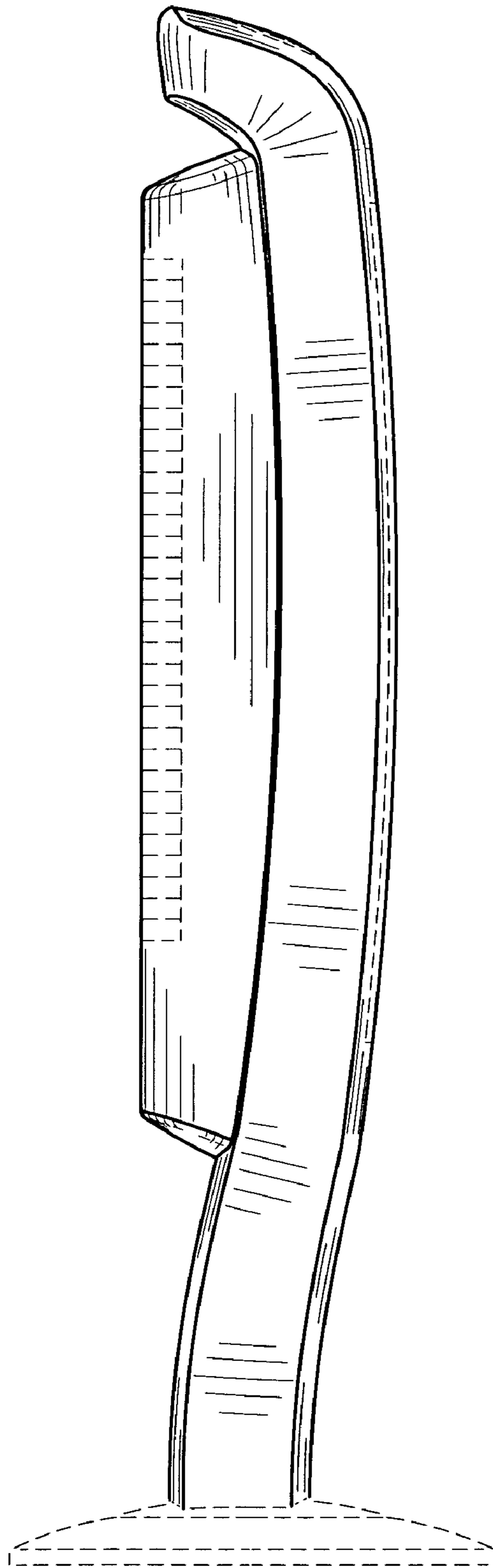

FIG. 5

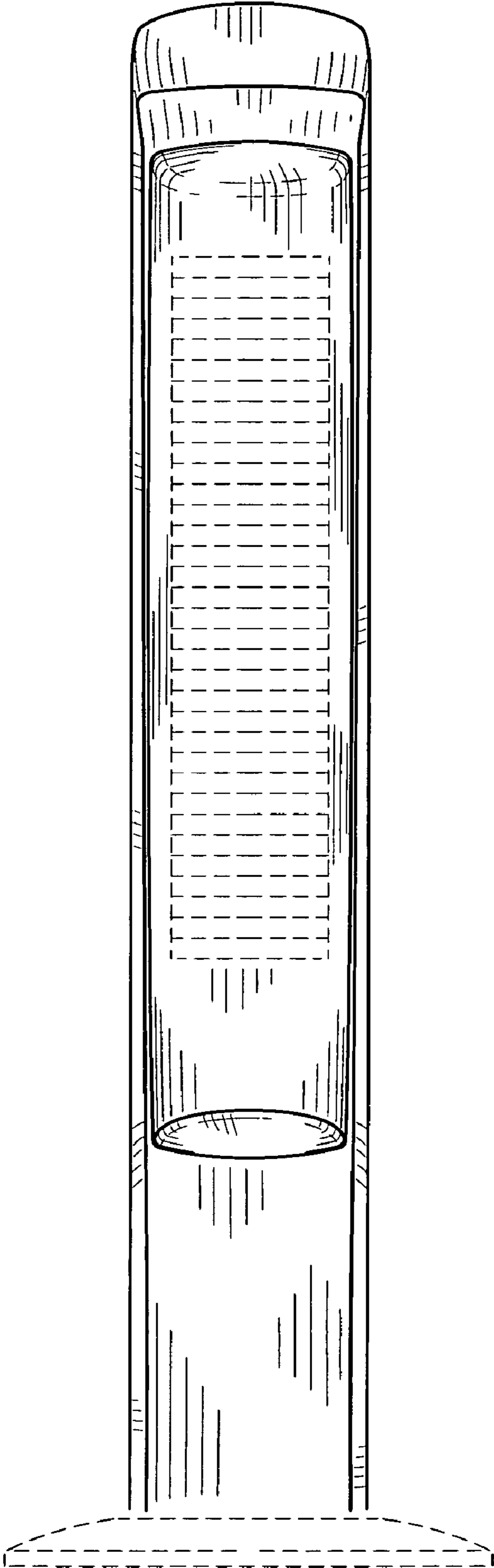

FIG. 6

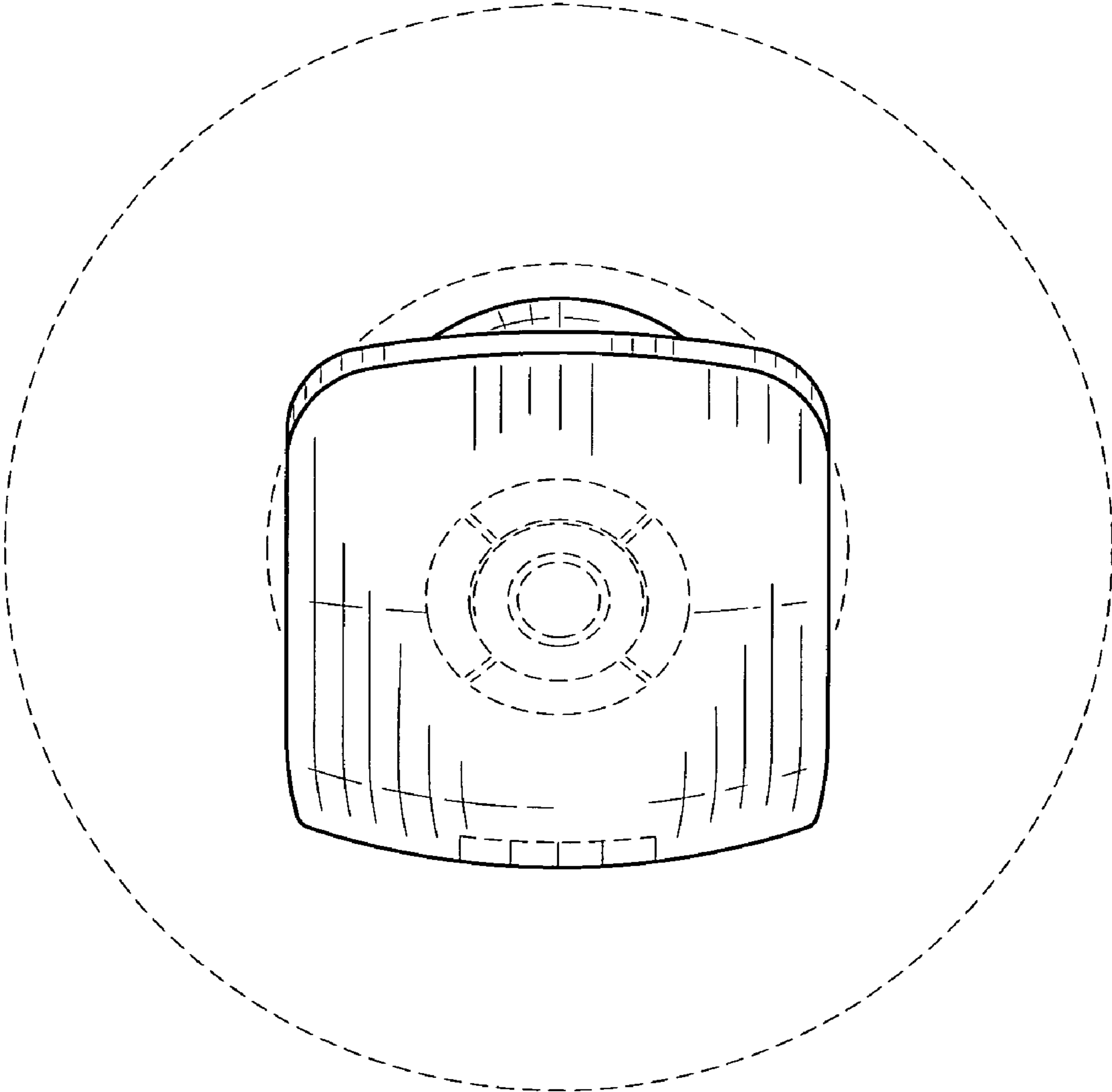

FIG. 7