



US00D634746S

(12) **United States Design Patent**  
**Tsai et al.**

(10) **Patent No.:** **US D634,746 S**  
(45) **Date of Patent:** **\*\* Mar. 22, 2011**

(54) **DISPLAY**

(75) Inventors: **Yao-Hsing Tsai**, Zhonghe (TW);  
**Chih-Hui Shen**, Zhonghe (TW);  
**Zhao-Rong Zhuz**, Zhonghe (TW)

(73) Assignee: **Top Victory Investments Ltd.**, Harbour  
(HK)

(\*\*) Term: **14 Years**

(21) Appl. No.: **29/359,544**

(22) Filed: **Apr. 13, 2010**

(51) **LOC (9) Cl.** ..... **14-02**

(52) **U.S. Cl.** ..... **D14/374**

(58) **Field of Classification Search** ..... D14/371-376,  
D14/125-129; 345/104, 156, 168, 173, 87,  
345/1.1, 901-905; 341/12; 348/180, 184,  
348/325, 739; 349/1, 2, 11, 58; 248/917-924,  
248/278.1; 361/679.23, 679.08  
See application file for complete search history.

(56) **References Cited**

**U.S. PATENT DOCUMENTS**

6,381,125 B1 \* 4/2002 Mizoguchi et al. .... 361/679.08  
D494,941 S \* 8/2004 Kim ..... D14/126  
6,807,051 B2 \* 10/2004 Takahashi ..... 361/679.23

D544,861 S \* 6/2007 Hwang ..... D14/375  
D551,186 S \* 9/2007 Yang et al. .... D14/126  
D556,160 S \* 11/2007 Lee et al. .... D14/126  
D595,295 S \* 6/2009 Shim ..... D14/374  
2004/0217244 A1 \* 11/2004 Wu et al. .... 248/278.1  
2005/0041379 A1 \* 2/2005 Jang ..... 361/681

\* cited by examiner

*Primary Examiner* — Freda S Nunn

(74) *Attorney, Agent, or Firm* — Alan Kamrath; Kamrath &  
Associates PA

(57) **CLAIM**

The ornamental design for display, as shown and described.

**DESCRIPTION**

FIG. 1 is a perspective view of a display showing our new design;  
FIG. 2 is a front side elevational view thereof;  
FIG. 3 is a rear side elevational view thereof;  
FIG. 4 is a left elevational view thereof;  
FIG. 5 is a right elevational view thereof;  
FIG. 6 is a top plan view thereof;  
FIG. 7 is a bottom plan view thereof; and,  
FIG. 8 is a rear perspective view thereof.

**1 Claim, 8 Drawing Sheets**

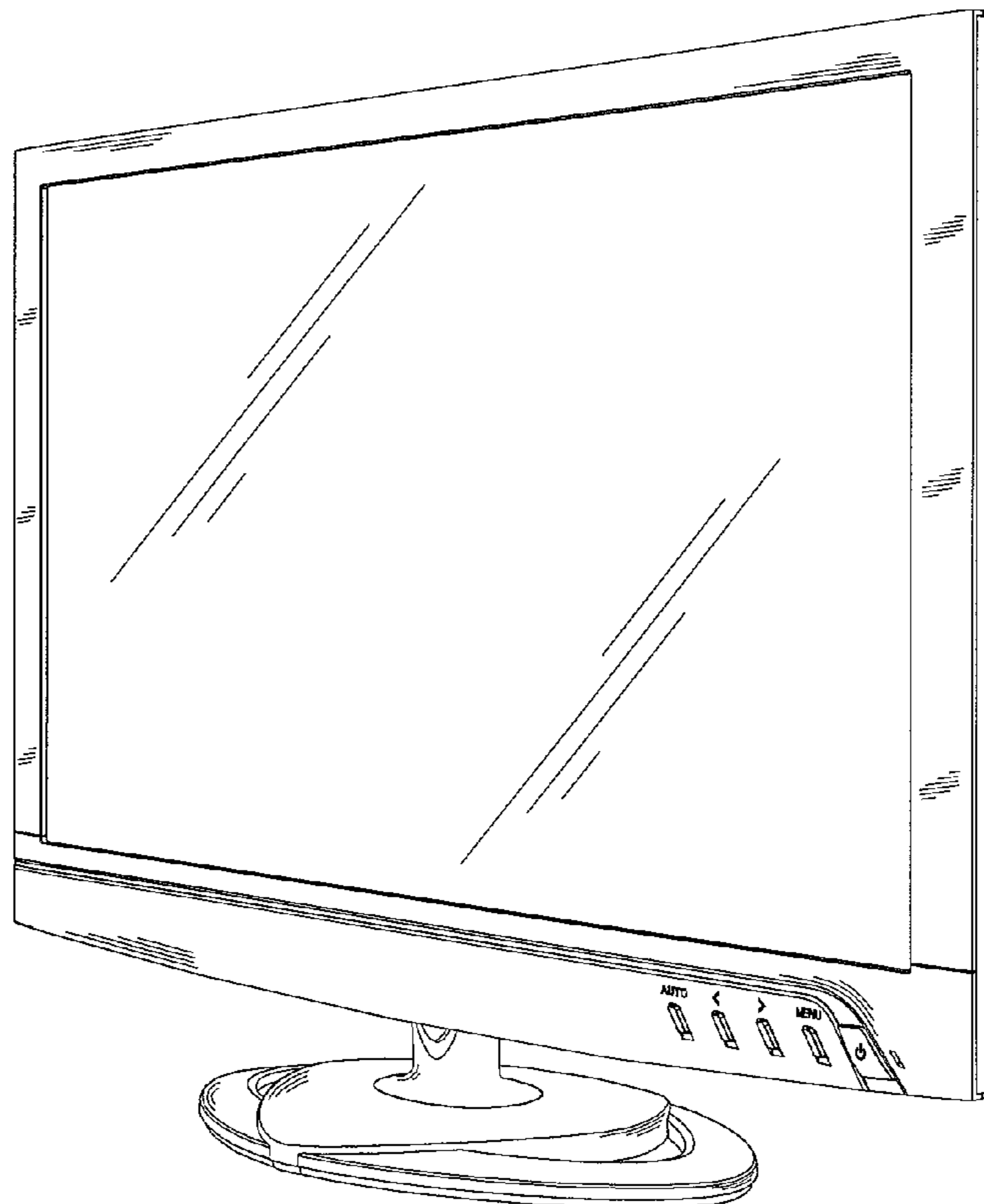

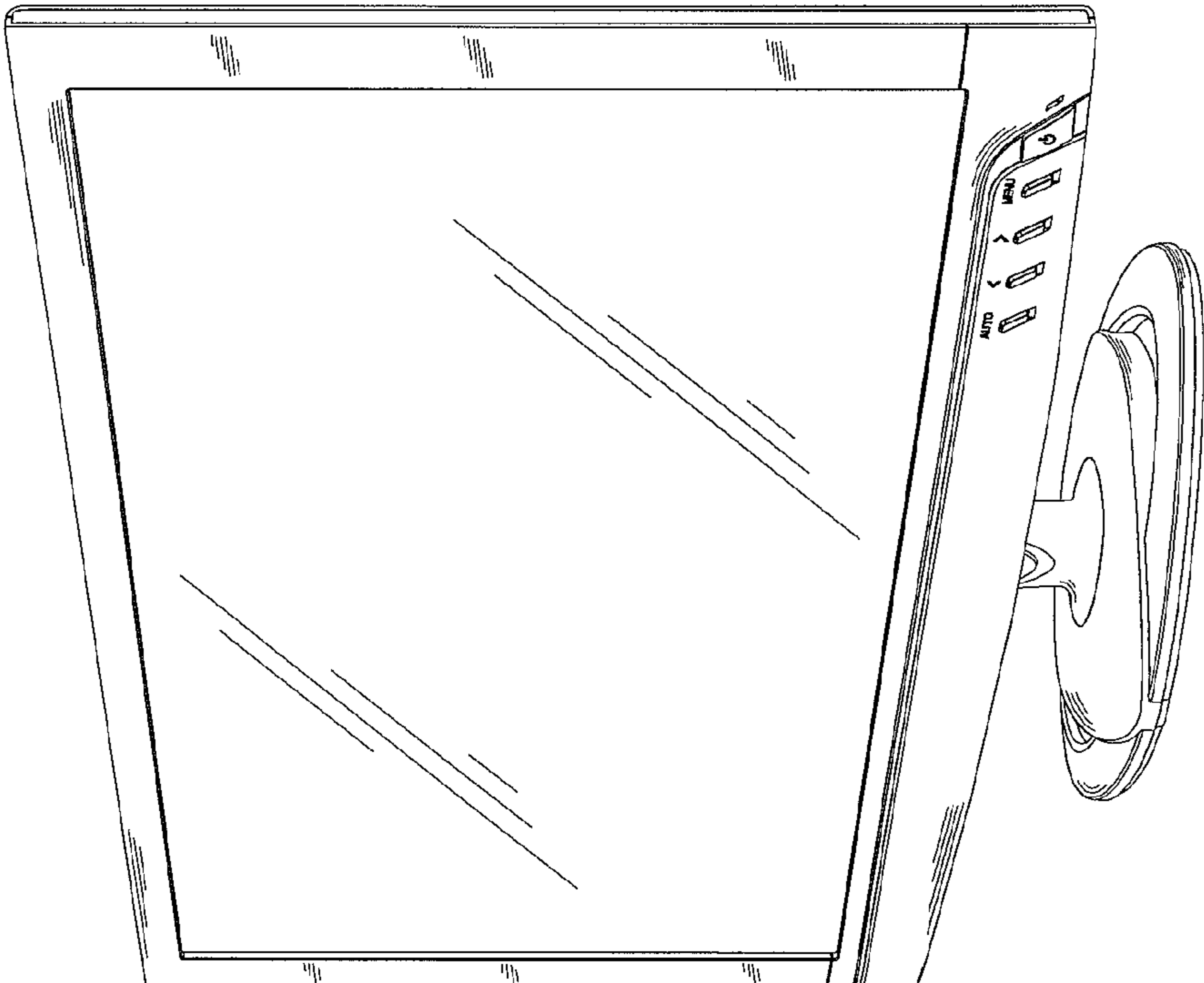

Fig. 1

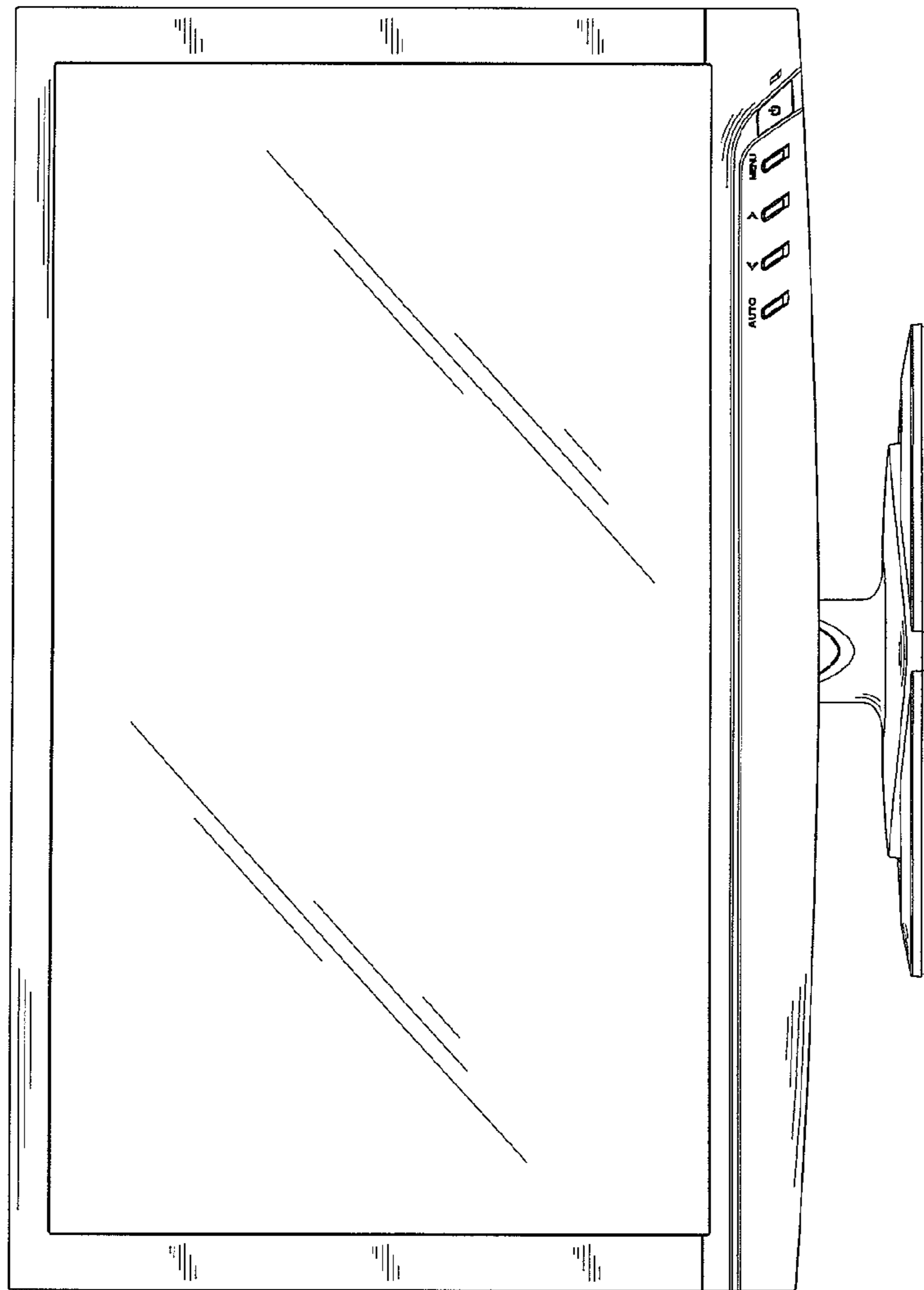

Fig. 2

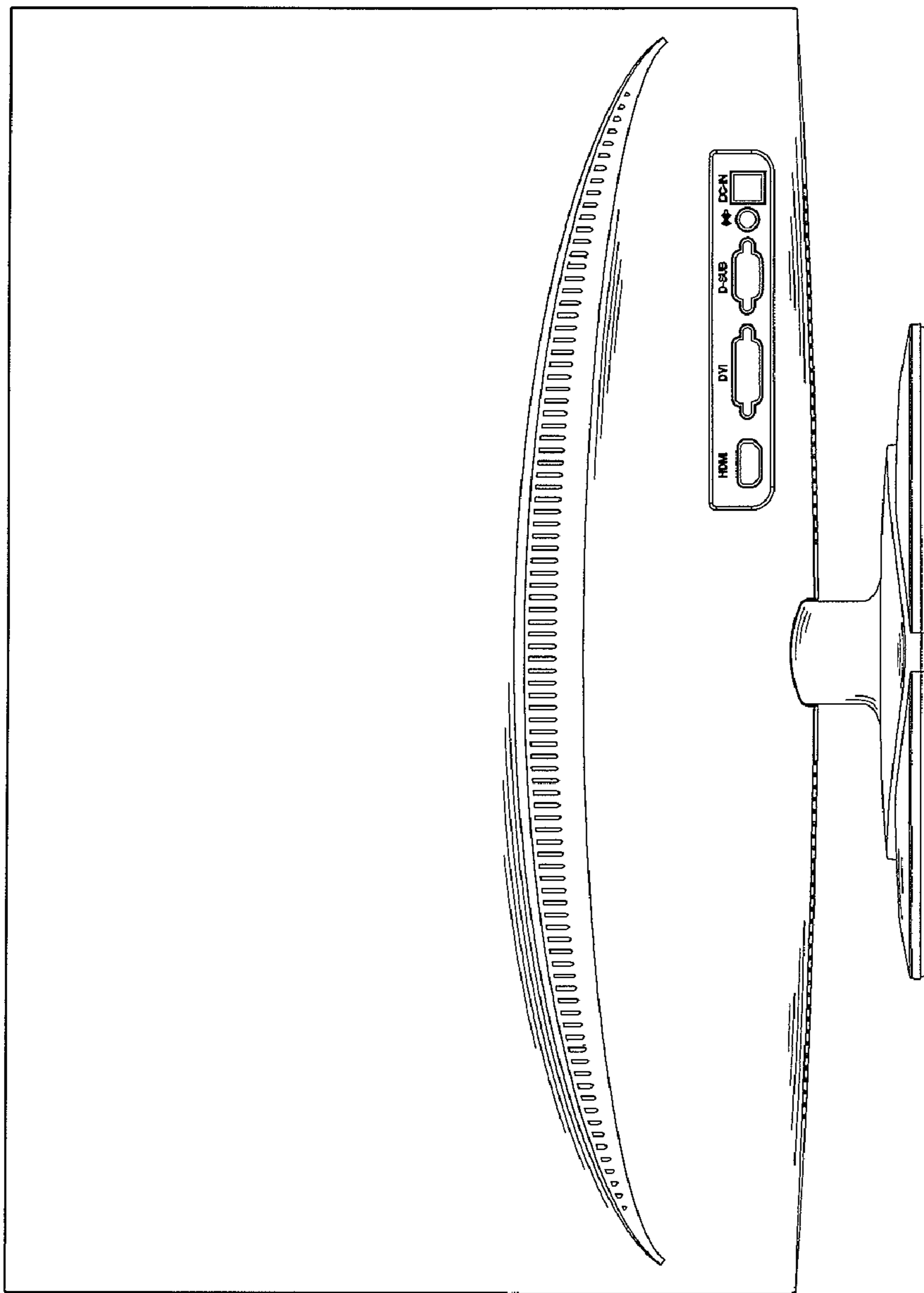

Fig. 3

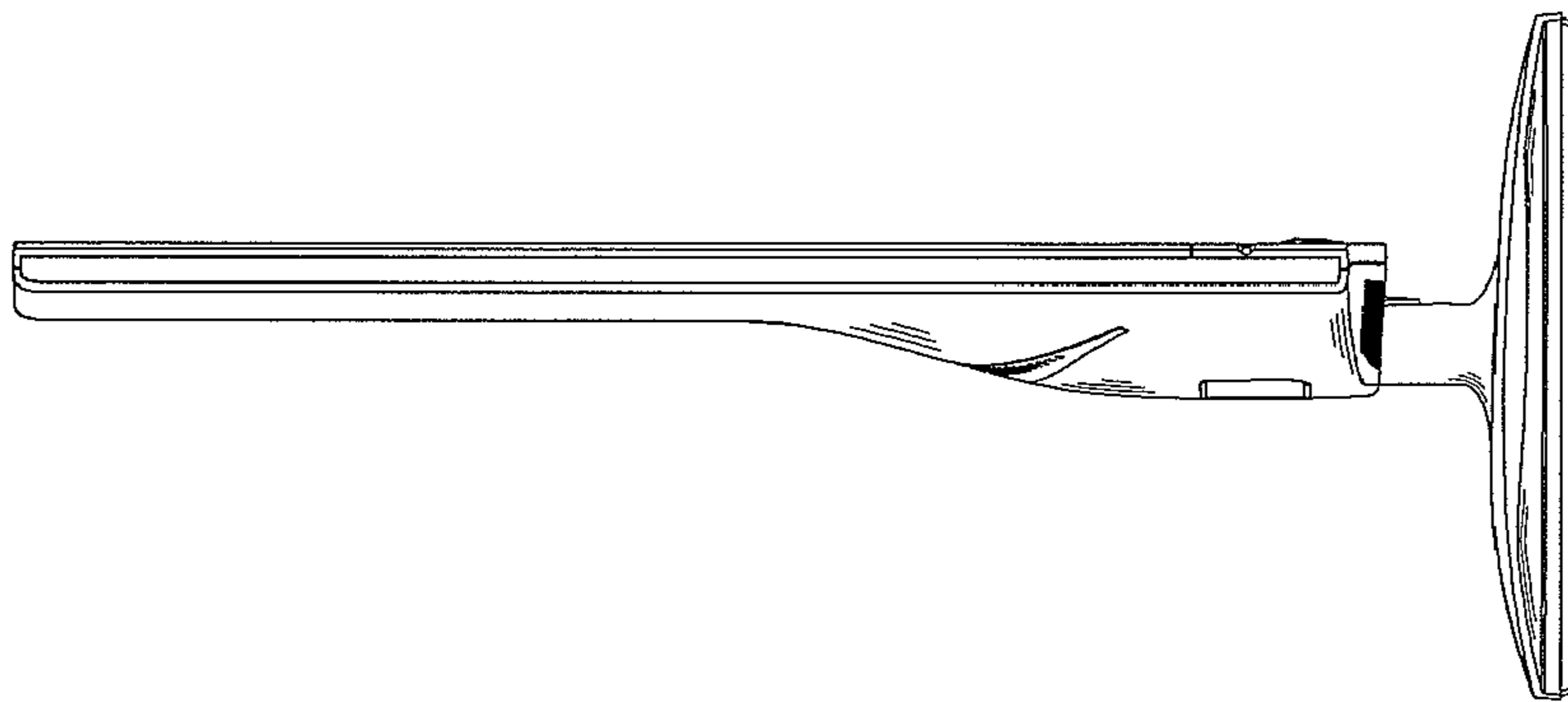

Fig. 4

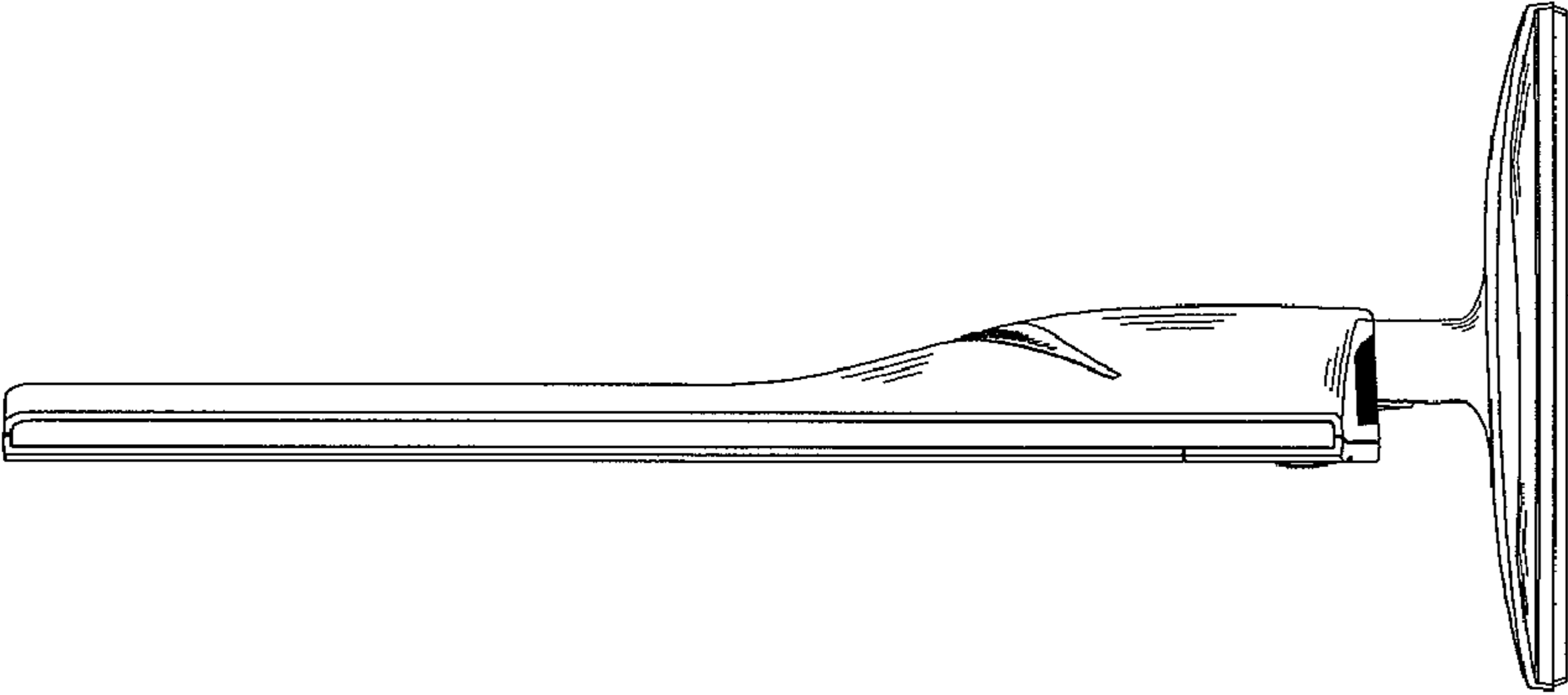

Fig. 5

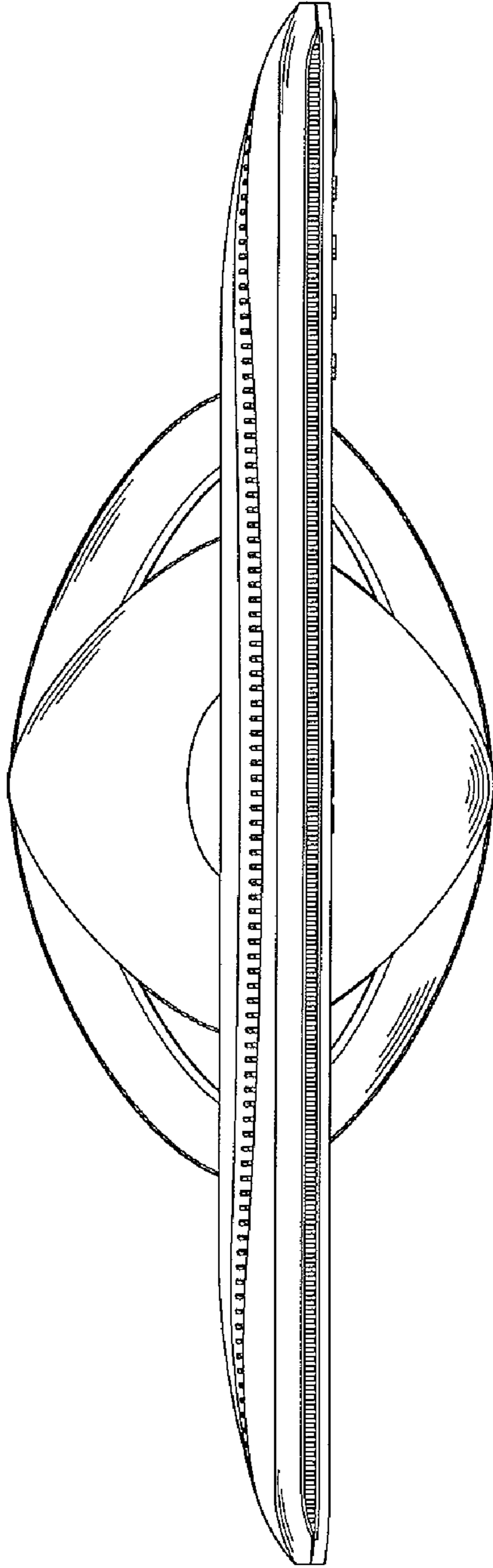

Fig. 6

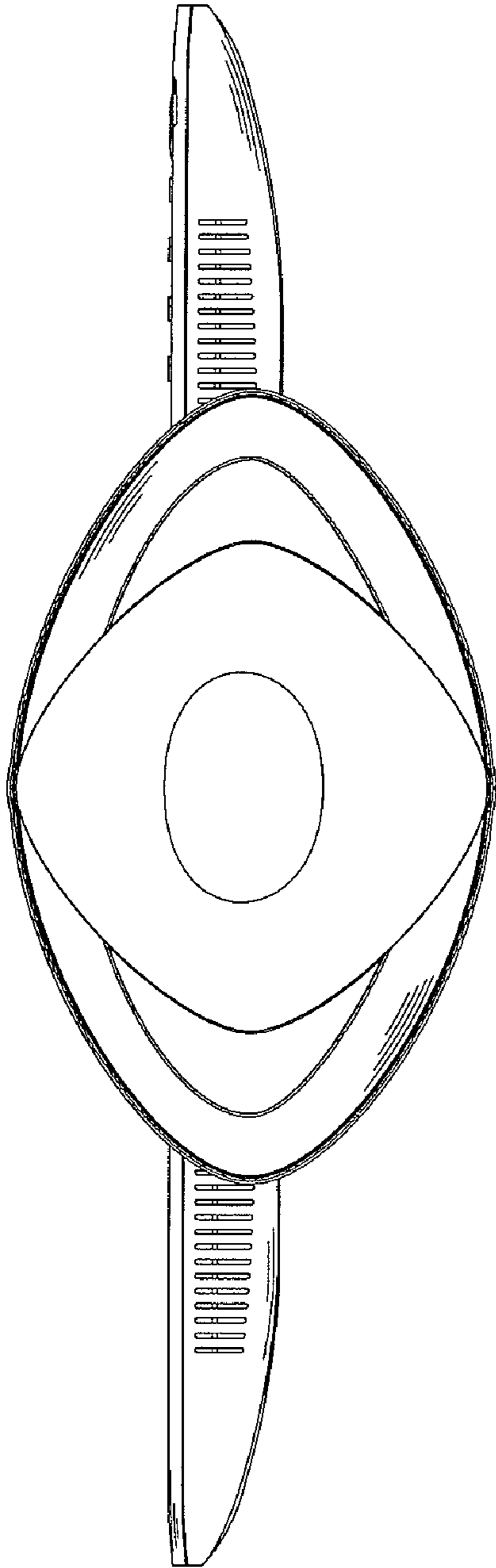

Fig. 7



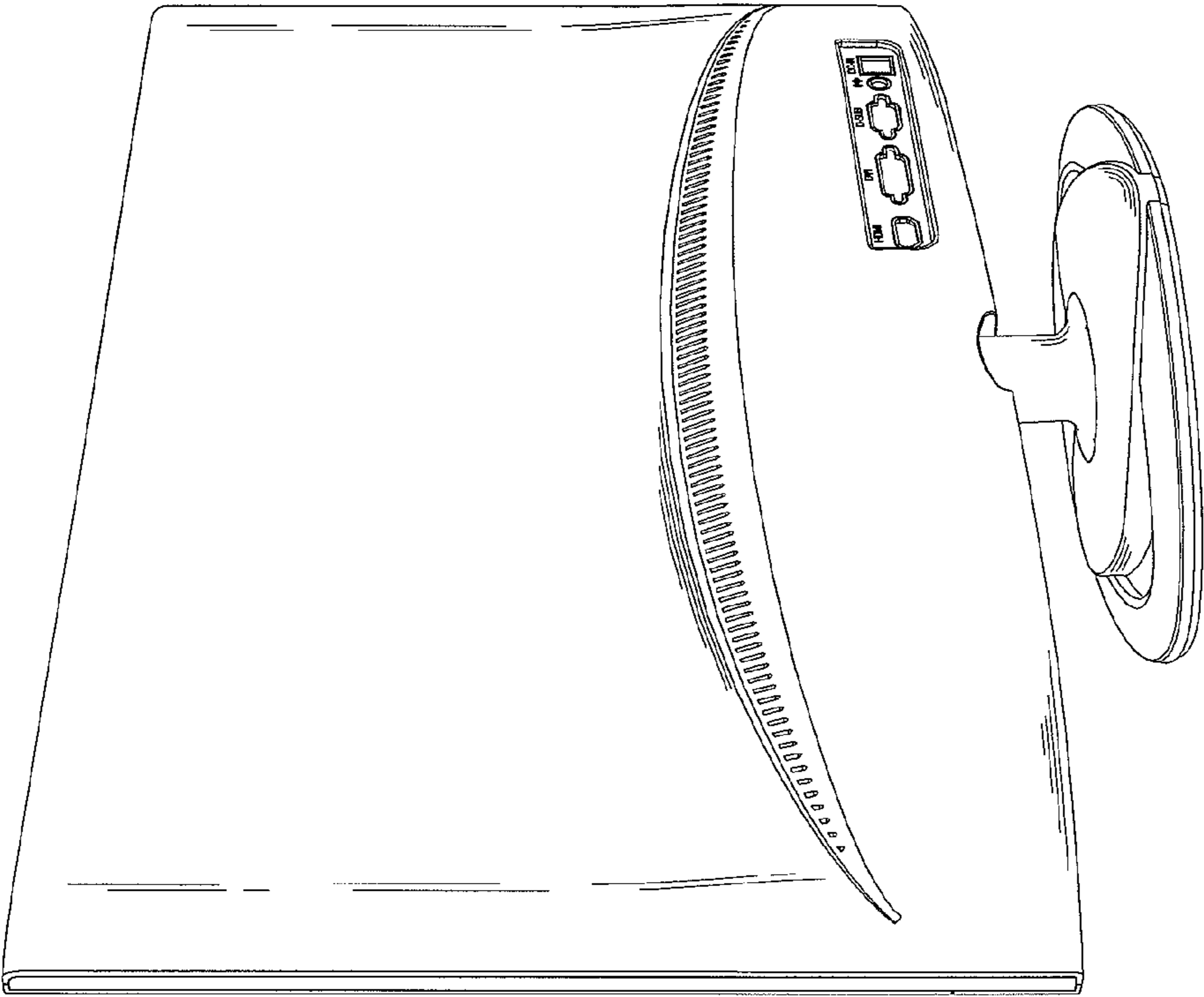

Fig. 8