



US00D634733S

(12) **United States Design Patent**
Lewis

(10) **Patent No.:** **US D634,733 S**
(45) **Date of Patent:** **** Mar. 22, 2011**

(54) **SUBWOOFER**

D518,026 S * 3/2006 Dayan D14/215
D547,746 S * 7/2007 Allen D14/211
D575,770 S * 8/2008 Lewis D14/216

(75) Inventor: **David Lewis**, Copenhagen (DK)

* cited by examiner

(73) Assignee: **Bang & Olufsen a/s**, Struer (DK)

Primary Examiner — Nanda Bondade

(**) Term: **14 Years**

(74) *Attorney, Agent, or Firm* — Buchanan Ingersoll & Rooney PC

(21) Appl. No.: **29/356,041**

(22) Filed: **Feb. 18, 2010**

(57) **CLAIM**

The ornamental design for a subwoofer, as shown and described.

(30) **Foreign Application Priority Data**

Aug. 24, 2009 (DK) DA 2009 00127

DESCRIPTION

(51) **LOC (9) Cl.** **14-01**

FIG. 1 is a front perspective view of a subwoofer showing my new design.

(52) **U.S. Cl.** **D14/216**

FIG. 2 is a rear perspective view thereof.

(58) **Field of Classification Search** D14/204,

FIG. 3 is a left side elevational view thereof.

D14/210–216, 168, 172; 181/143–144, 147–148,

FIG. 4 is a right side elevational view thereof.

181/150–153, 157, 198–199; 381/300–303,

FIG. 5 is a front elevational view thereof.

381/306, 332–333, 336, 345, 361–364, 386–388

FIG. 6 is a rear elevational view thereof.

See application file for complete search history.

FIG. 7 is a top plan view thereof; and,

(56) **References Cited**

FIG. 8 is a bottom plan view thereof.

U.S. PATENT DOCUMENTS

The broken line showing is for illustrative purposes only and forms no part of the claimed design.

D440,557 S * 4/2001 Su D14/215

D491,921 S * 6/2004 Takeuchi et al. D14/216

1 Claim, 8 Drawing Sheets

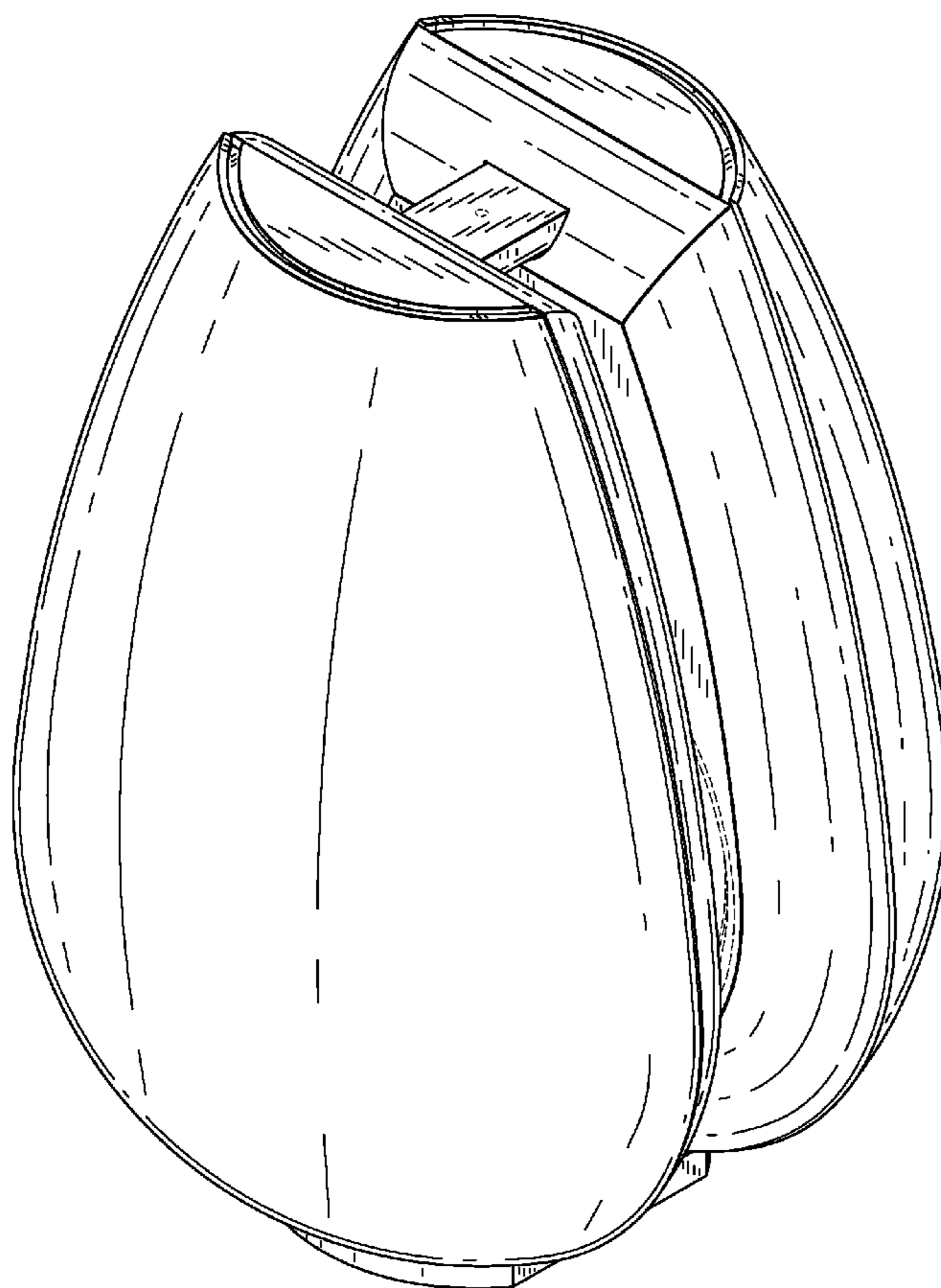

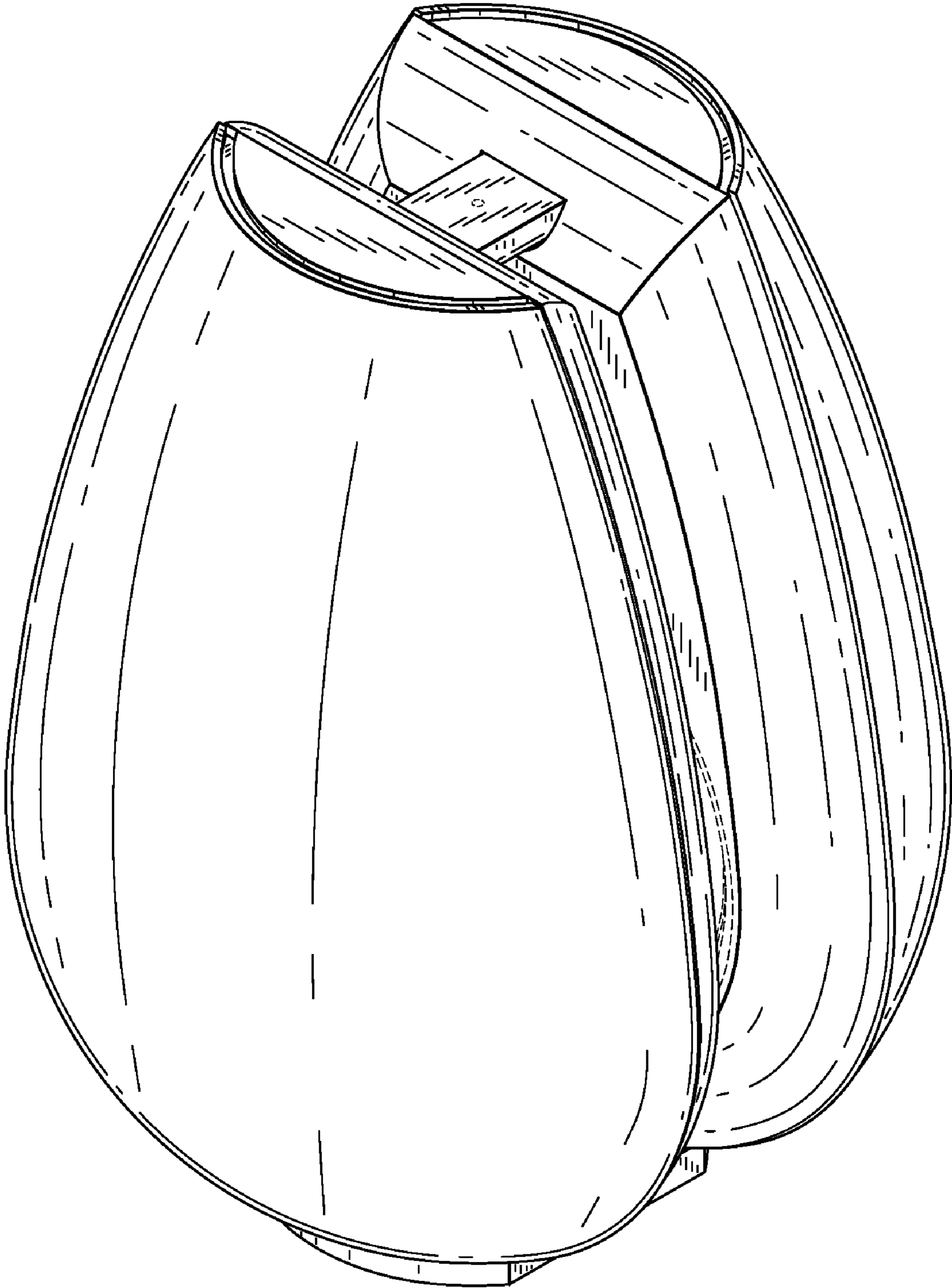

FIG. 1

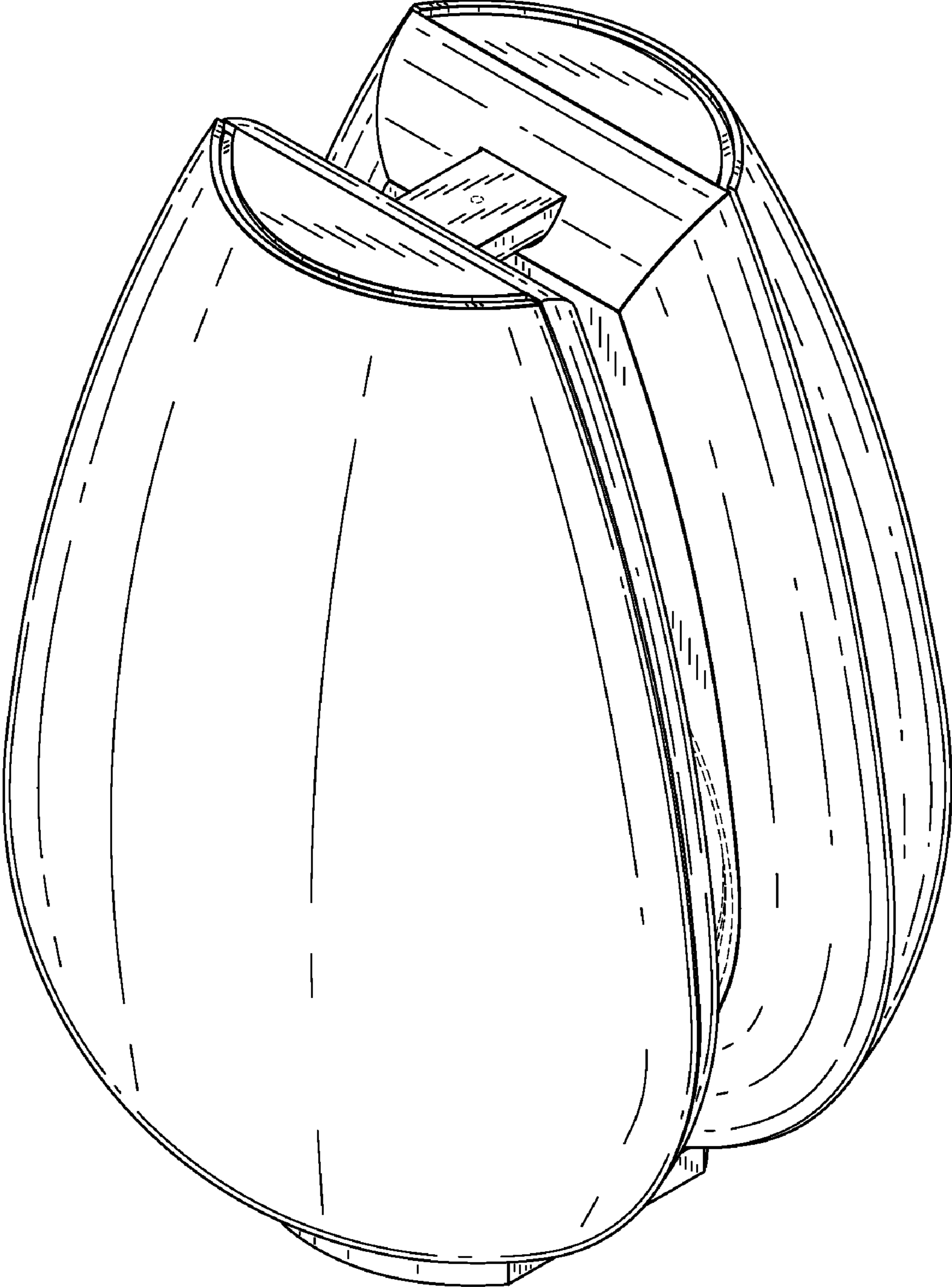

FIG. 2

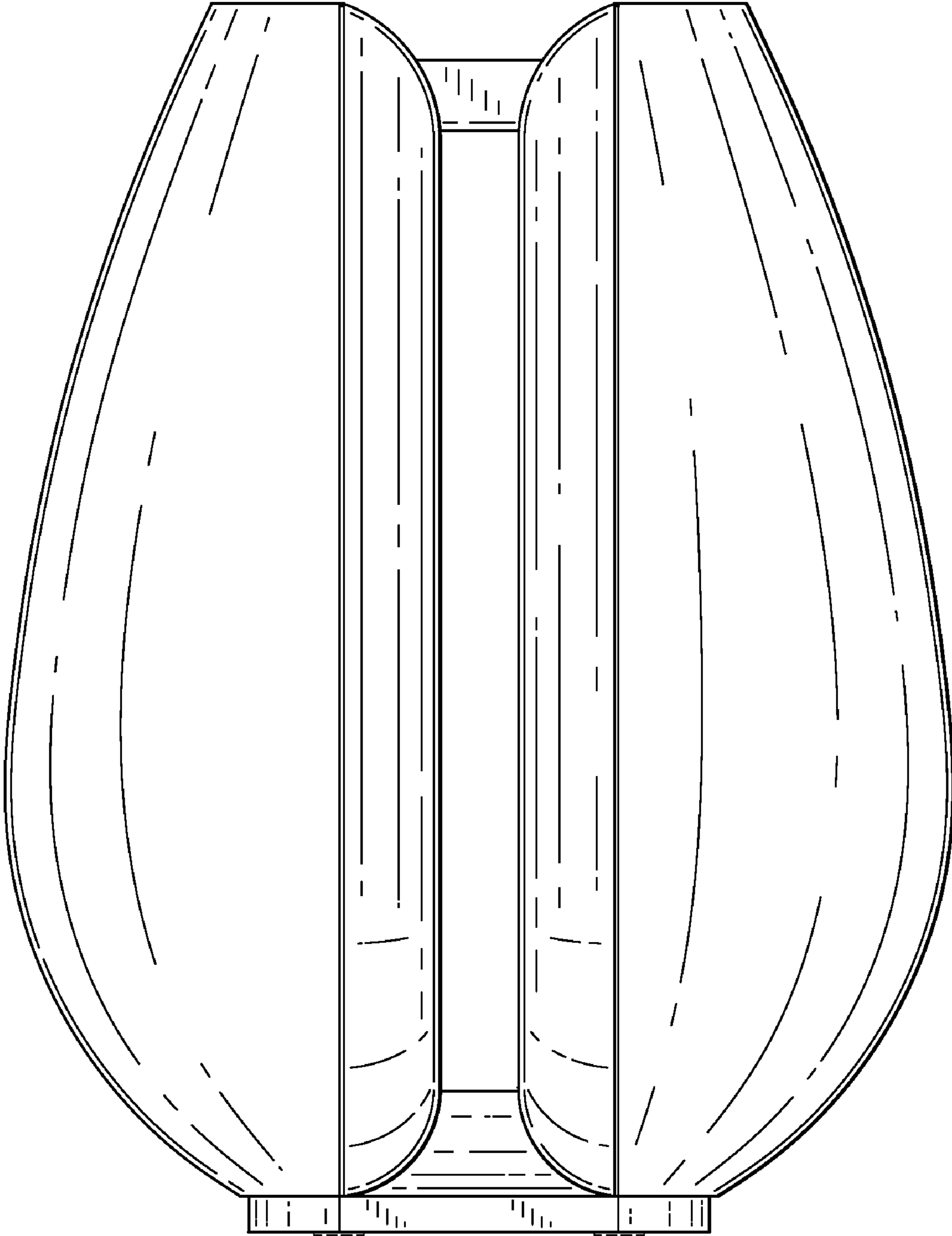

FIG. 3

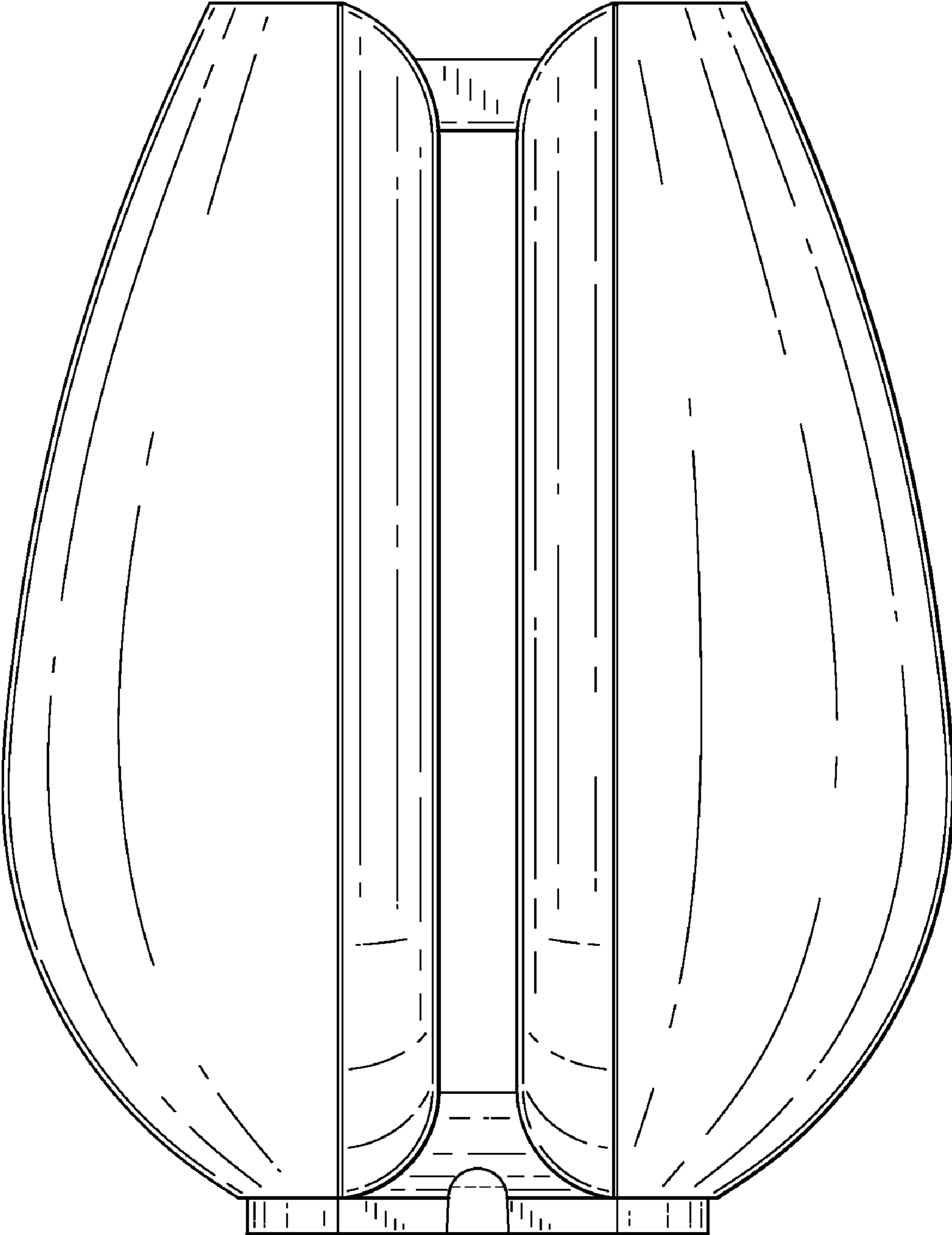

FIG. 4

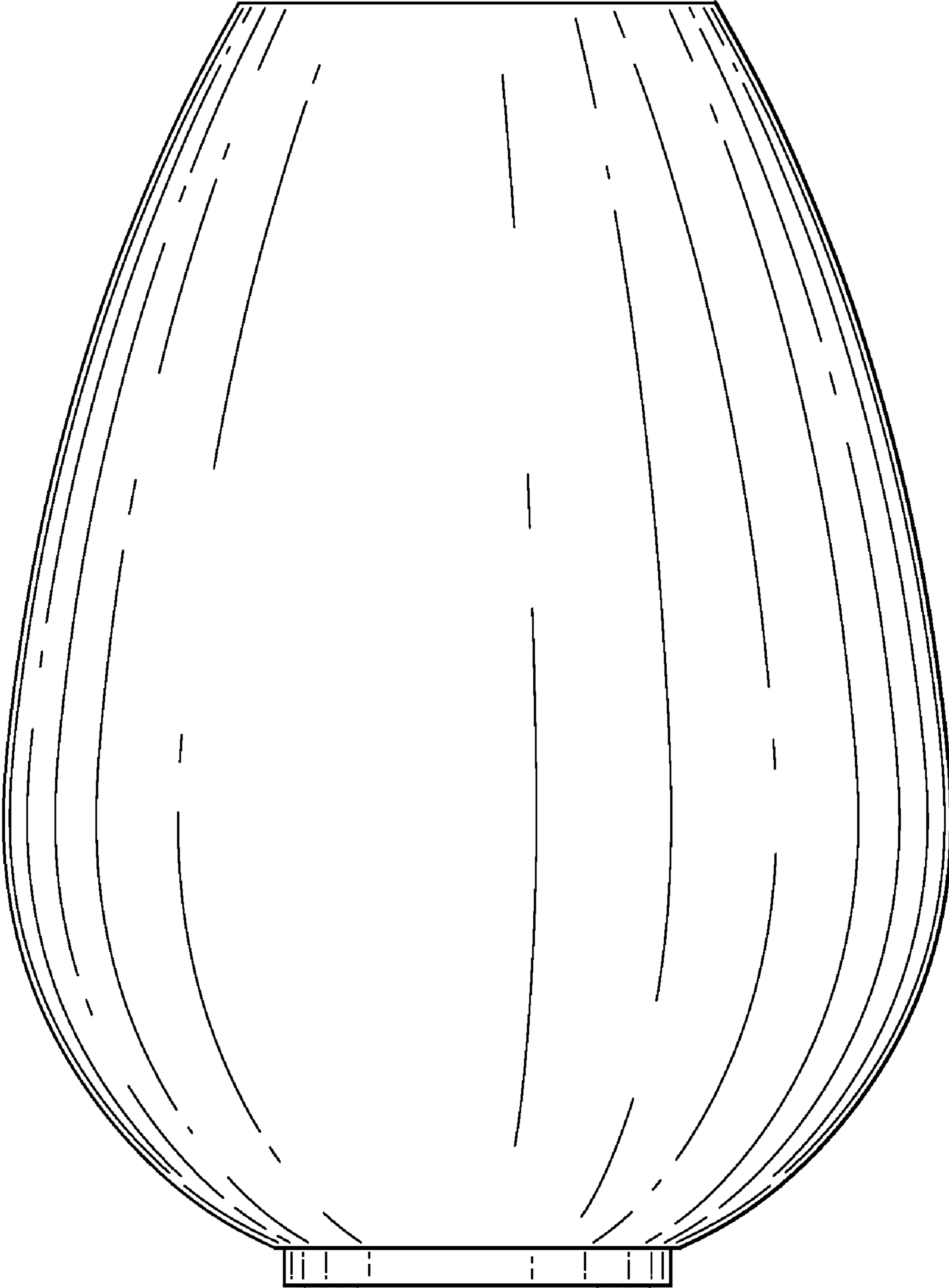

FIG. 5

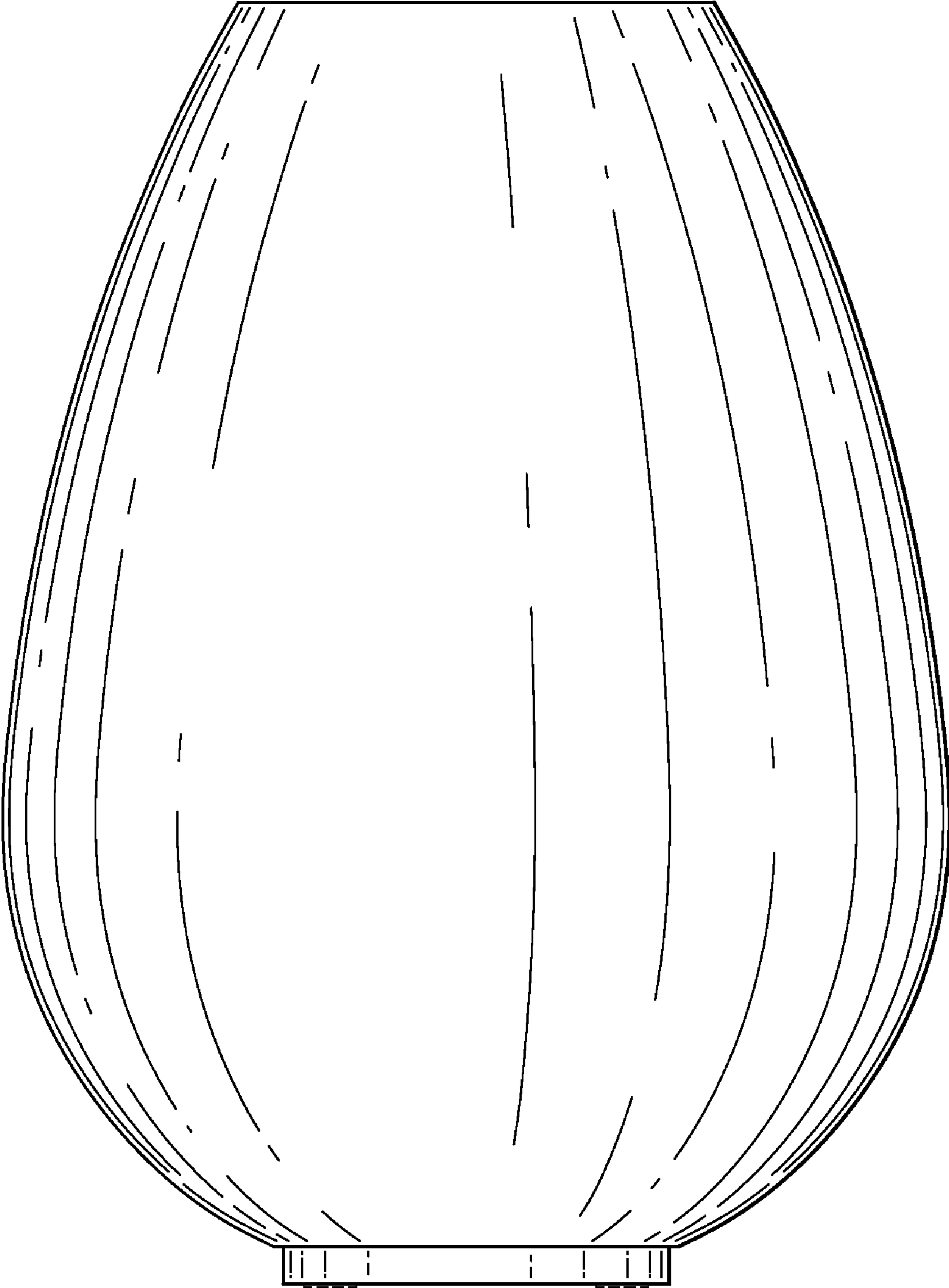

FIG. 6

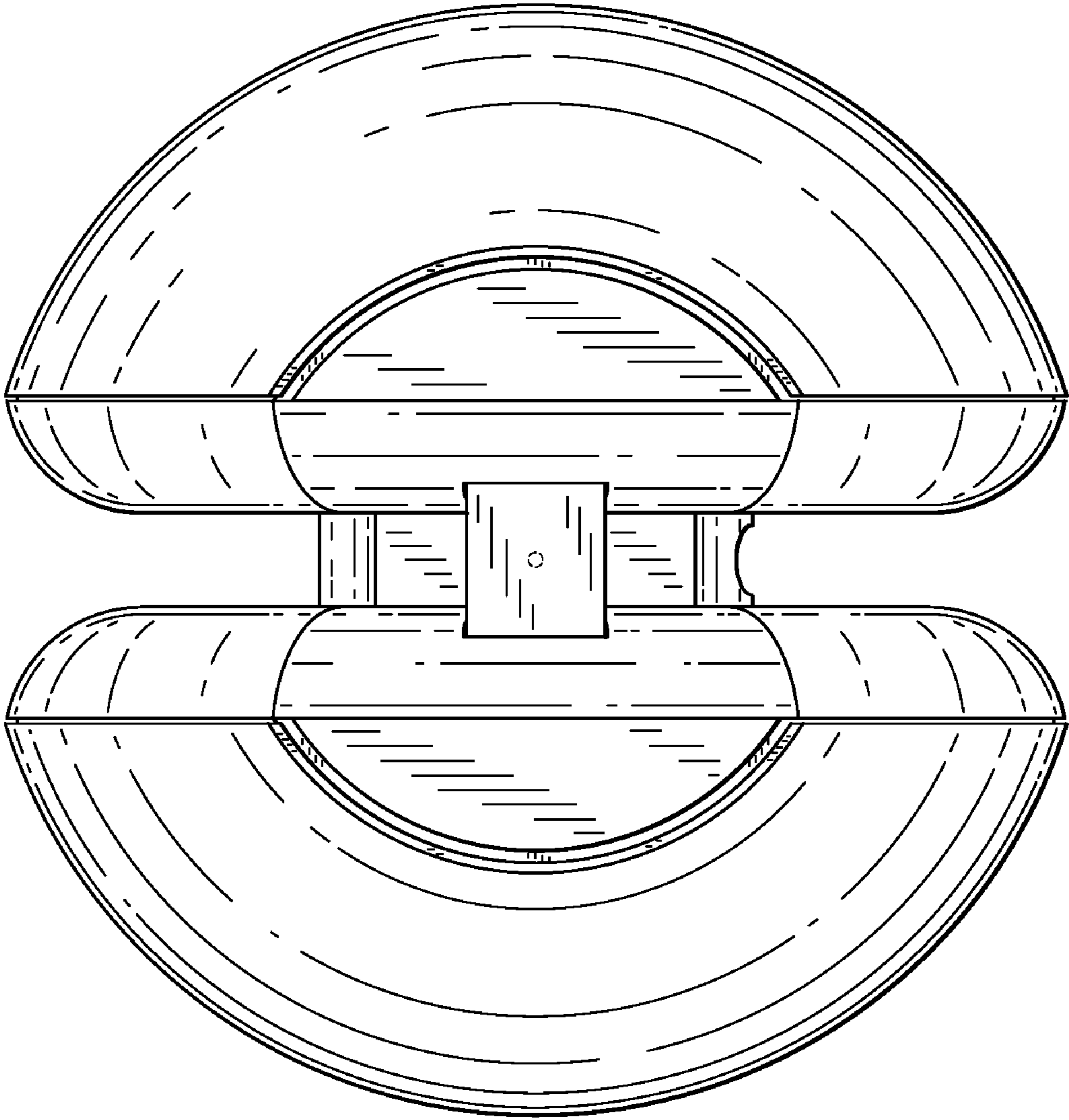

FIG. 7

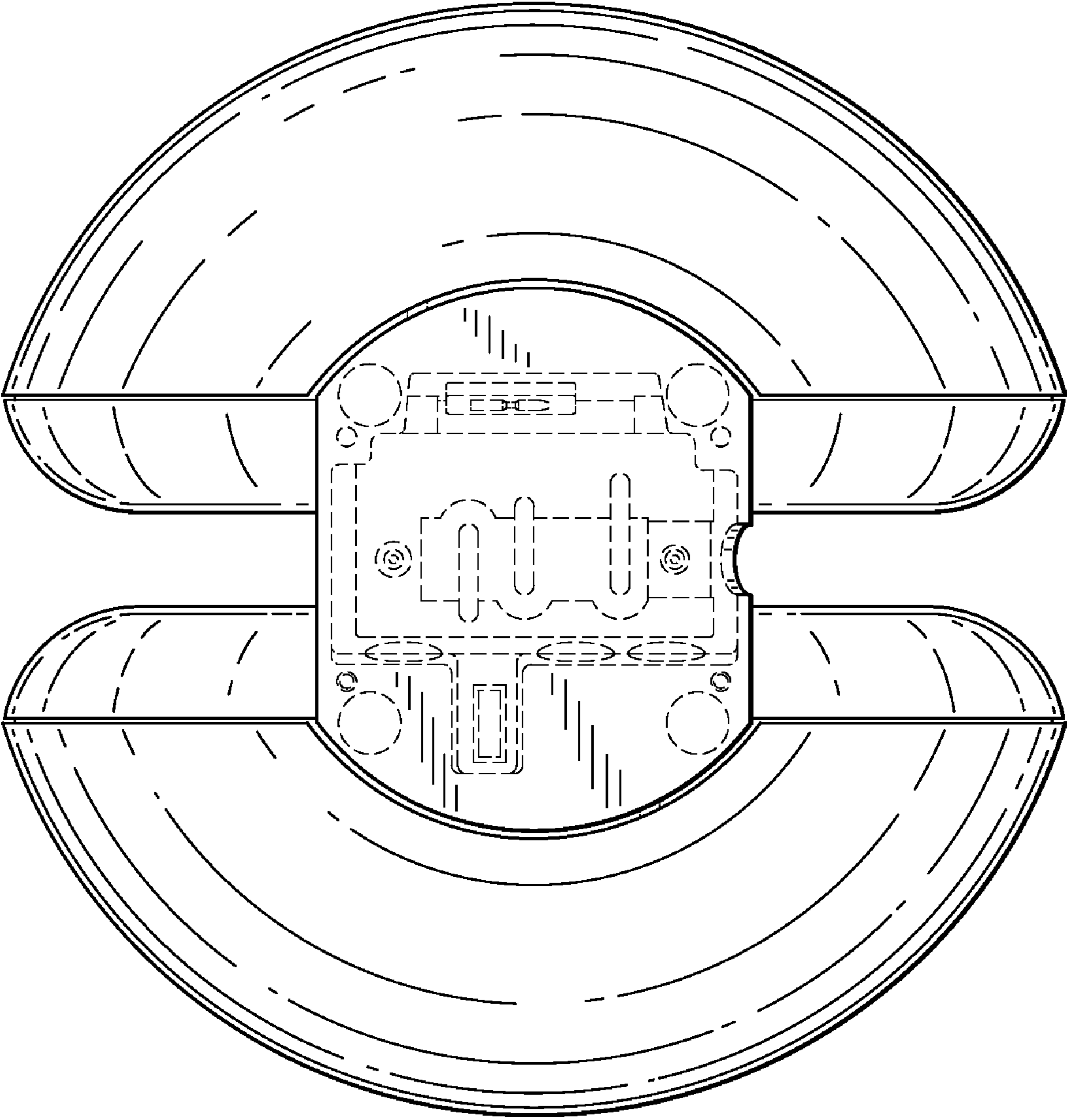

FIG. 8