



US00D634726S

(12) **United States Design Patent**
Harden et al.

(10) **Patent No.:** **US D634,726 S**
(45) **Date of Patent:** **** Mar. 22, 2011**

(54) **HANDSET**

(75) Inventors: **Daniel K. Harden**, Palo Alto, CA (US);
Christopher L. Whittall, Los Gatos, CA
(US); **Chang Fan Chen**, San Jose, CA
(US); **Andrew R. Church**, Oakland, CA
(US); **Jaime F. Guerrero**, San Francisco,
CA (US)

(73) Assignee: **Cisco Technology, Inc.**, San Jose, CA
(US)

(**) Term: **14 Years**

(21) Appl. No.: **29/363,179**

(22) Filed: **Jun. 5, 2010**

Related U.S. Application Data

(62) Division of application No. 29/352,372, filed on Dec.
19, 2009, now Pat. No. Des. 627,328.

(51) **LOC (9) Cl.** **14-03**

(52) **U.S. Cl.** **D14/147**

(58) **Field of Classification Search** D14/138 R,
D14/138 AA, 138 AD, 143-144, 147-148,
D14/218, 247-248, 341-347, 390, 496, 140,
D14/142, 240, 149-151, 250-253, 329-330,
D14/357, 434, 471; D13/168; D21/517;
343/702; 348/14.01-14.02; 361/814;
379/433.01-433.13; 439/165; 455/90.3,
455/556.1-556.2, 566, 575.1, 575.3, 575.4;
345/167, 168, 169

See application file for complete search history.

(56) **References Cited**

U.S. PATENT DOCUMENTS

D210,668 S 4/1968 Janda
D297,009 S * 8/1988 Grambush et al. D14/138 R
D298,751 S * 11/1988 Shin D14/138 AA
D326,449 S 5/1992 Wachob et al.
D348,062 S 6/1994 Iseli et al.
D348,667 S 7/1994 Oksman et al.

D352,282 S 11/1994 Toh et al.
D356,560 S * 3/1995 Kornfeld et al. D14/138 AA
D365,102 S 12/1995 Gioscia
D367,061 S * 2/1996 Davison D14/218

(Continued)

FOREIGN PATENT DOCUMENTS

WO DM/068600 2/2007

OTHER PUBLICATIONS

U.S. Appl. No. 29/352,370, filed Dec. 19, 2009, entitled "Set-Top
Unit," Inventor(s): Daniel K. Harden et al.

(Continued)

Primary Examiner — Robert M Spear

Assistant Examiner — Carla Jobe Wright

(74) *Attorney, Agent, or Firm* — Patent Capital Group

(57) **CLAIM**

The ornamental design for a handset, as shown and described.

DESCRIPTION

This application is related to co-pending design application
Ser. No. 29/363,178, filed Jun. 5, 2010, entitled "Handset".
The disclosure of these design applications are considered
part of and are incorporated by reference.

FIG. 1 is a front perspective view of a handset showing our
new design;

FIG. 2 is a front view thereof;

FIG. 3 is a back view thereof;

FIG. 4 is a side view thereof;

FIG. 5 is another side view thereof;

FIG. 6 is a top view thereof; and,

FIG. 7 is a bottom view thereof.

The broken lines immediately adjacent the claimed surfaces
represent boundaries of the claimed design. All other broken
lines depict unclaimed environment. The broken lines and
unshaded regions bounded by broken lines form no part of the
claimed design.

1 Claim, 5 Drawing Sheets

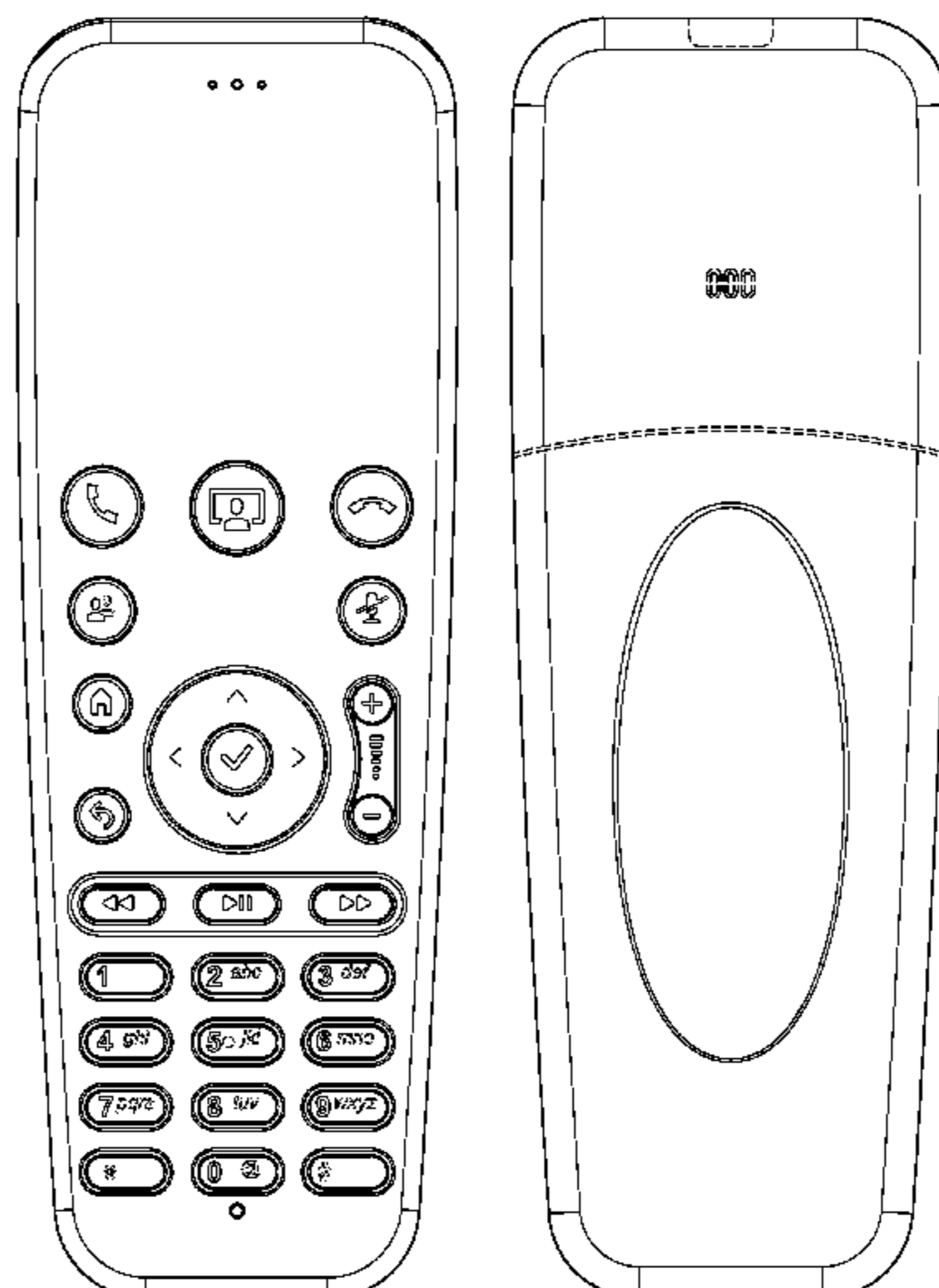

U.S. PATENT DOCUMENTS

D368,892 S 4/1996 Tanaka
 D369,163 S 4/1996 Leung et al.
 D369,358 S * 4/1996 Estevez-Alcolado et al. D14/248
 D381,634 S 7/1997 Yanku
 D385,263 S * 10/1997 Taylor D14/407
 D385,541 S 10/1997 Taylor
 D394,266 S 5/1998 Hogenbirk
 D395,281 S 6/1998 Waldner
 D395,312 S 6/1998 Parsadayan et al.
 D406,134 S * 2/1999 Bigand D14/138 AA
 D406,142 S 2/1999 Meurer
 D407,703 S 4/1999 Stokes
 D423,509 S 4/2000 Park
 6,049,192 A 4/2000 Kfoury et al.
 D426,232 S 6/2000 Silbermann et al.
 D426,808 S 6/2000 Hsiao
 D427,966 S 7/2000 Foster et al.
 D430,861 S 9/2000 Lytel
 D436,582 S * 1/2001 Angele D14/138 AA
 D437,310 S 2/2001 Gioscia
 D451,498 S 12/2001 Rossel
 D454,332 S 3/2002 Yokoyama
 D458,250 S 6/2002 Kim et al.
 D458,915 S * 6/2002 Shintani D14/147
 D459,332 S 6/2002 Peiker
 D472,235 S 3/2003 Chen
 D473,220 S 4/2003 Smith et al.
 D473,550 S 4/2003 Ribeiro et al.
 D475,346 S 6/2003 McCurrach et al.
 D478,074 S 8/2003 Lam
 D481,032 S * 10/2003 Sinclair D14/248
 6,633,641 B1 * 10/2003 Mushika et al. 379/368
 D483,353 S 12/2003 Hyogo
 D485,827 S 1/2004 Olson et al.
 D485,828 S * 1/2004 Olson et al. D14/218
 D491,922 S 6/2004 Poulet
 D494,230 S 8/2004 Allen
 D501,205 S 1/2005 Quinn
 D517,036 S 3/2006 Himmel
 D517,532 S 3/2006 Chen
 D524,276 S * 7/2006 Kim et al. D14/138 AA
 D524,277 S 7/2006 Surtouc
 D524,278 S 7/2006 Hsiung
 D524,281 S 7/2006 Franck et al.
 D531,136 S 10/2006 Schoenert et al.
 D531,964 S 11/2006 Peh
 D531,993 S 11/2006 Choi et al.
 D532,775 S * 11/2006 Ikeda et al. D14/218
 D534,502 S 1/2007 Poulet et al.
 D534,519 S 1/2007 Stilp et al.
 D535,276 S 1/2007 Franck et al.
 D538,788 S * 3/2007 Reimann et al. D14/218
 D541,245 S 4/2007 Fiorio
 D541,786 S 5/2007 Ookawa
 D542,765 S 5/2007 Cho et al.
 D546,807 S 7/2007 Lee
 D550,211 S 9/2007 Ikeda et al.
 D555,107 S 11/2007 Choi et al.
 D558,707 S * 1/2008 Travis et al. D14/138 AA
 D559,202 S 1/2008 Sim et al.
 D563,948 S 3/2008 d'Hoore

D566,667 S 4/2008 Whittaker et al.
 D566,668 S 4/2008 Whittaker et al.
 D569,823 S * 5/2008 Lyles et al. D14/138 AA
 D571,743 S 6/2008 Tu
 D573,567 S * 7/2008 Chang et al. D14/138 AA
 D573,971 S 7/2008 Hikino et al.
 D573,982 S * 7/2008 Monsky D14/218
 D574,355 S 8/2008 Okawa et al.
 D575,316 S 8/2008 Liu et al.
 D577,693 S 9/2008 King et al.
 D579,871 S 11/2008 Hsiao
 D583,366 S 12/2008 Chen
 D587,707 S 3/2009 Maiers et al.
 D589,926 S * 4/2009 Turner D14/138 AA
 D589,928 S * 4/2009 Haspil et al. D14/147
 D590,395 S 4/2009 Heggkand
 D590,792 S * 4/2009 Chang et al. D14/138 AA
 D597,059 S 7/2009 Haspil et al.
 D598,408 S 8/2009 Arnold
 D598,436 S 8/2009 Tseng
 D605,634 S 12/2009 Lewis et al.
 D606,034 S 12/2009 Suzuki
 D607,432 S 1/2010 Waterman et al.
 D609,203 S * 2/2010 Birsal et al. D14/138 R
 D611,462 S 3/2010 McGuire
 D615,958 S * 5/2010 Tkachuk et al. D14/148
 D618,657 S * 6/2010 Sakamoto D14/147
 D618,658 S * 6/2010 Sakamoto et al. D14/147
 2008/0204978 A1 8/2008 Haspil et al.

OTHER PUBLICATIONS

U.S. Appl. No. 29/352,371, filed Dec. 19, 2009, entitled "Camera Assembly," Inventor(s): Daniel K. Harden et al.
 U.S. Appl. No. 29/352,372, filed Dec. 19, 2009, entitled "Handset," Inventor(s): Daniel K. Harden et al.
 U.S. Appl. No. 29/363,178, filed Jun. 5, 2010, entitled "Handset," Inventor(s): Daniel K. Harden et al.
 U.S. Appl. No. 29/352,373, filed Dec. 19, 2009, entitled "Cradle Device," Inventor(s): Daniel K. Harden et al.
 U.S. Appl. No. 29/352,374, filed Dec. 19, 2009, entitled "Handset," Inventor(s): Daniel K. Harden et al.
 U.S. Appl. No. 29/363,157, filed Jun. 4, 2010, entitled "Handset," Inventor(s): Daniel K. Harden et al.
 U.S. Appl. No. 29/363,160, filed Jun. 4, 2010, entitled "Handset," Inventor(s): Daniel K. Harden et al.
 Panasonic KX-TGA670B, <URL:http://www.101phones.com/details/1991-229/panasonic-kx-tga670.html>, retrieved from internet Apr. 20, 2010, 1 page.
 GE/RCE ViSYS H5450RE3-R, <URL:http://www.101phones.com/details/15753-5126/ge-rca-h5450re3.html>, retrieved from internet Apr. 20, 2010, 1 page.
 Cisco Wireless-g Ip Phone Sip 1LINE 802.11AG Speakerphone Incl Pwr Supl, <URL:http://www.amazon.com/Cisco-Wireless-g-Phone-802-11AG-Speakerphone/dp/B001F3YIJK/ref=sr_1_8?ie=UTF8&s=electronics&qid=1273357442&sr=1-8>, retrieved from internet May 8, 2010, 1 page.
 Vtech DS6301, <URL:http://www.101phones.com/details/11797-12287/vtech-ds6301.html>, retrieved from internet May 8, 2010, 1 page.

* cited by examiner

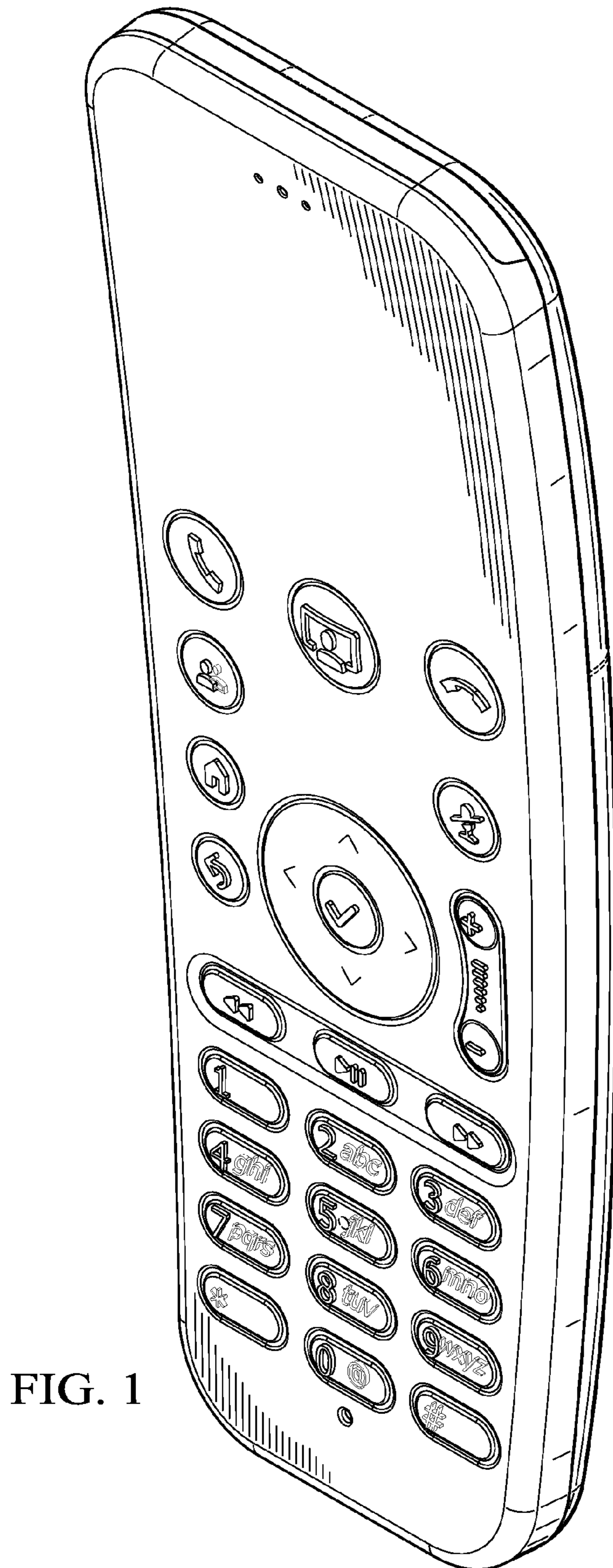

FIG. 1

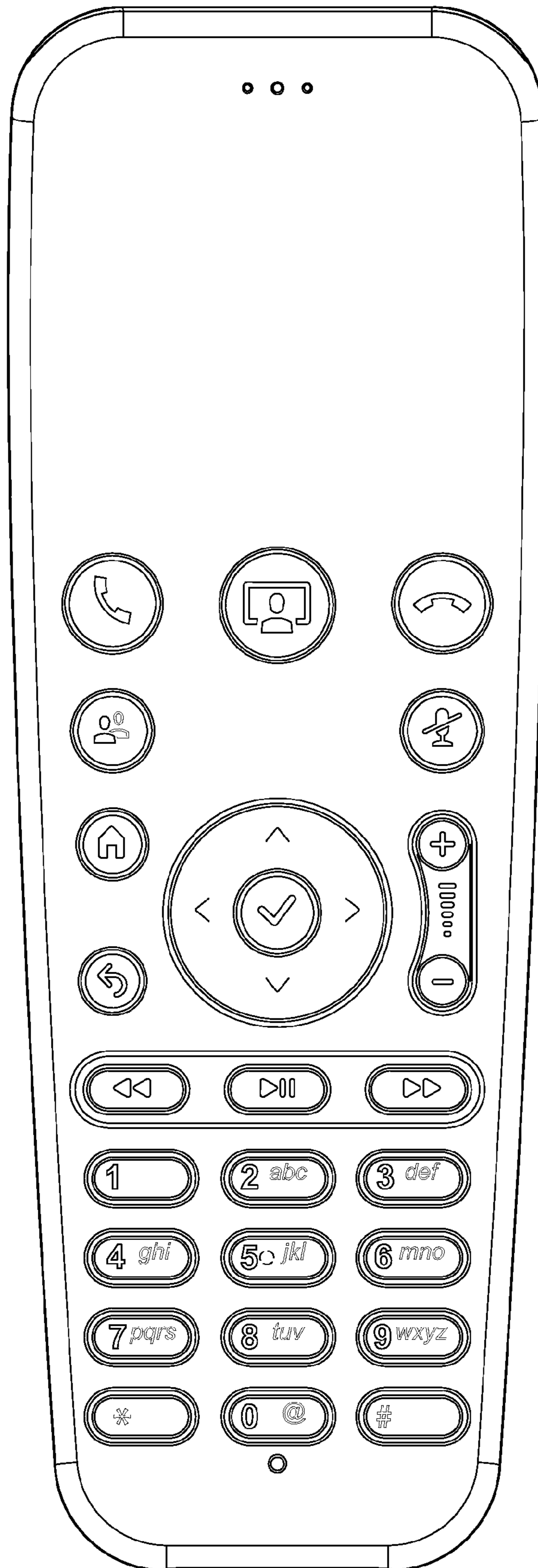

FIG. 2

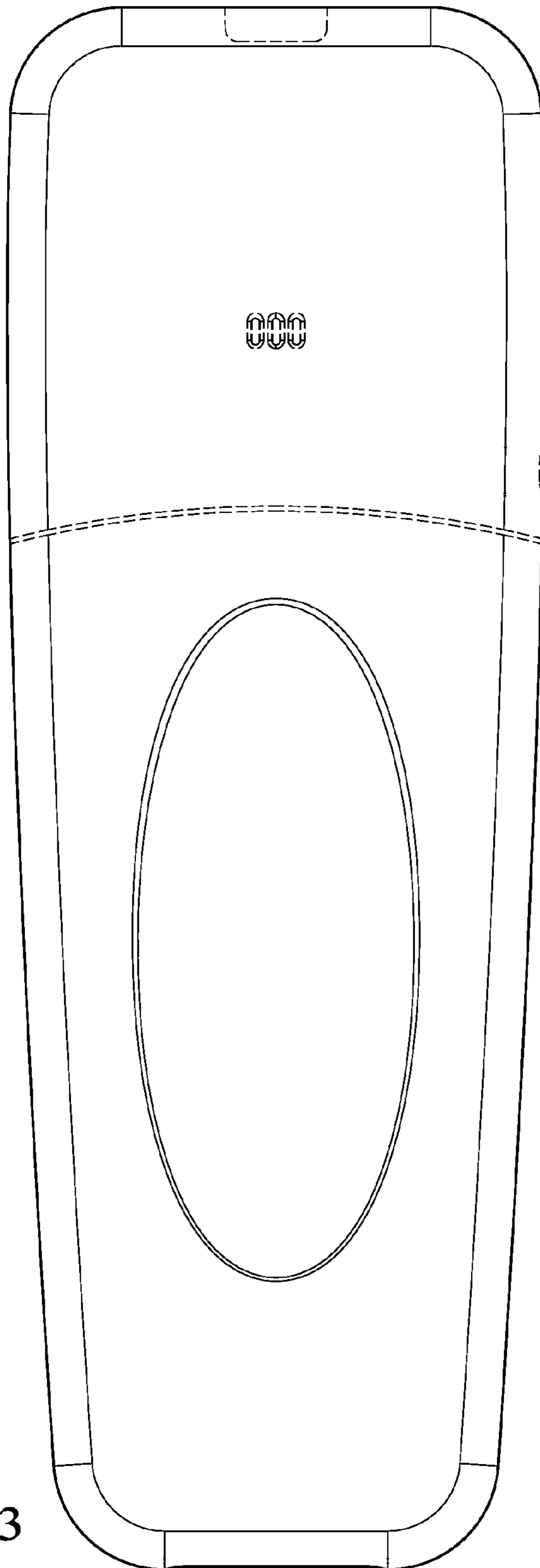

FIG. 3

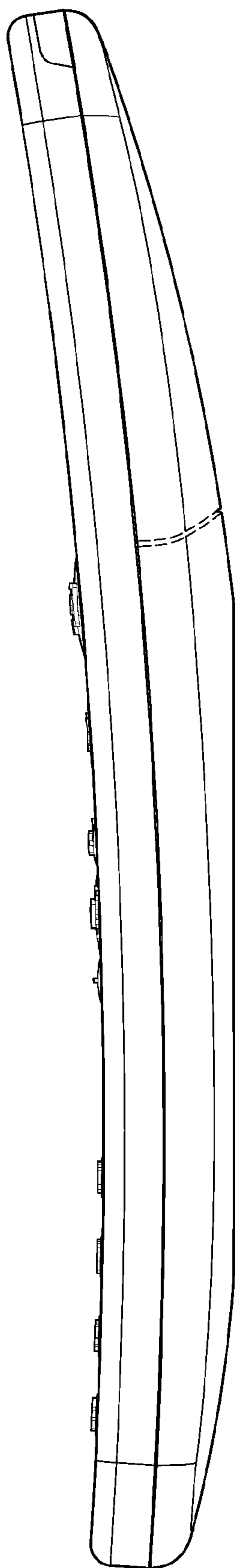

FIG. 4

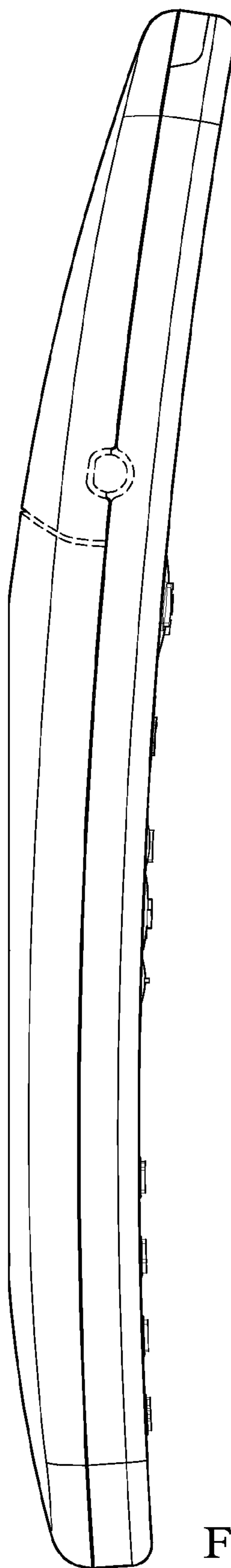

FIG. 5

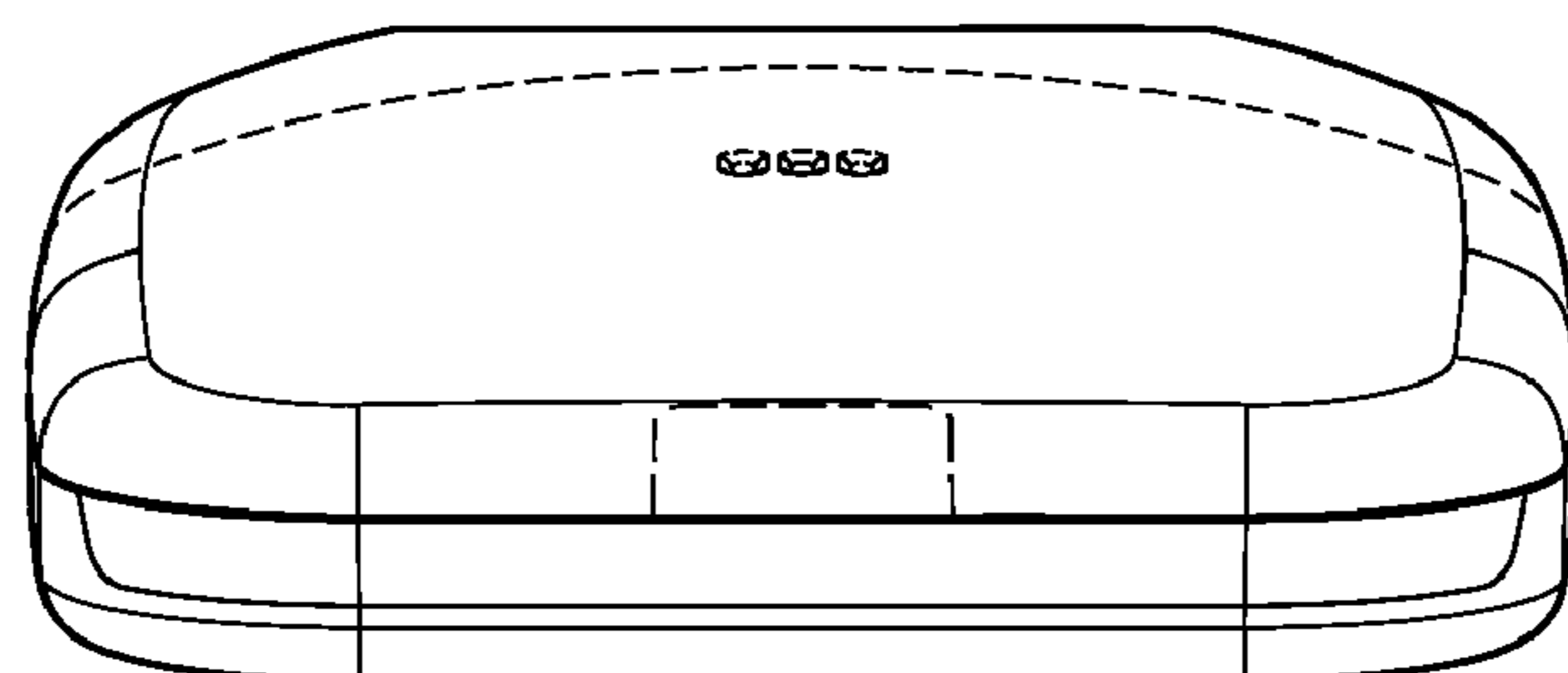

FIG. 6

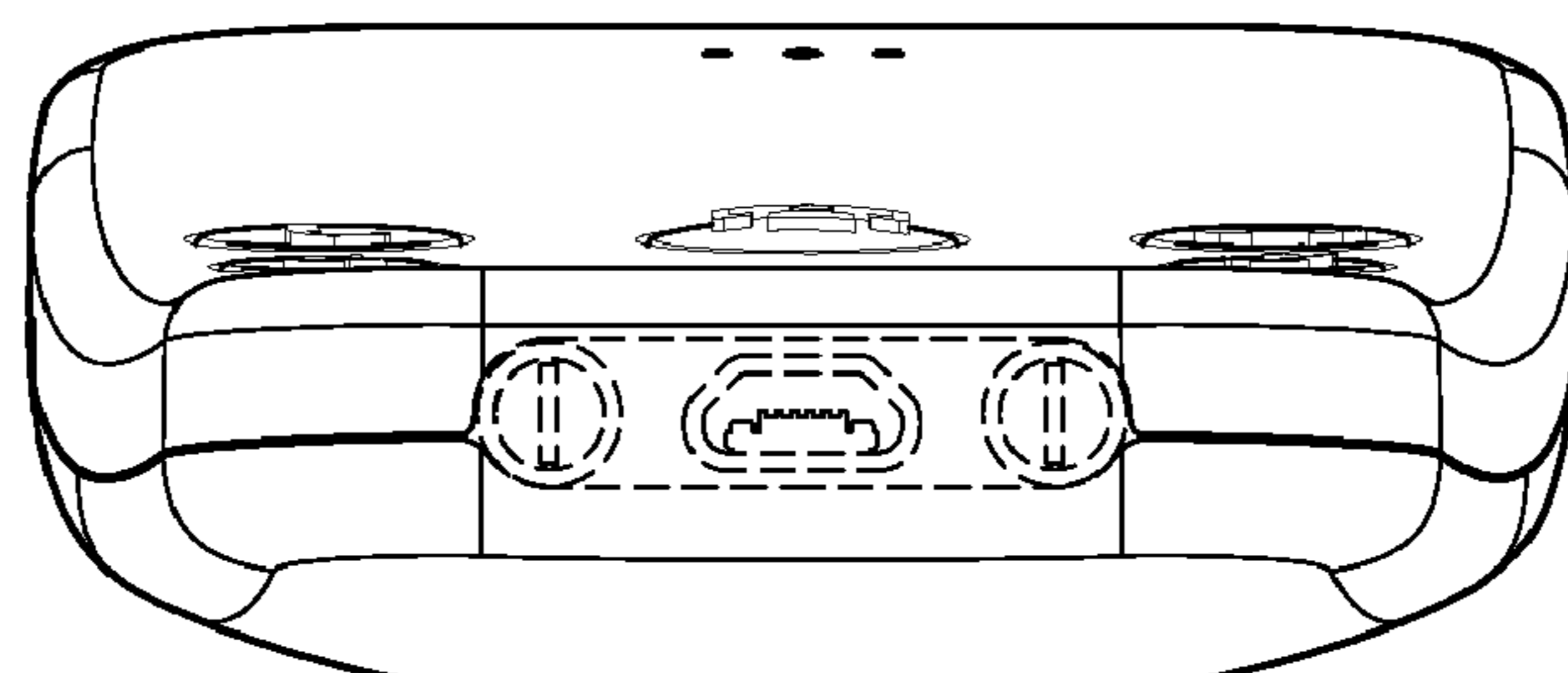

FIG. 7