



US00D634684S

(12) **United States Design Patent**
Hodges

(10) **Patent No.:** **US D634,684 S**

(45) **Date of Patent:** **** Mar. 22, 2011**

(54) **MOTORCYCLE FAIRING EXTENSION**

(76) Inventor: **Robert D. Hodges**, Amarillo, TX (US)

(**) Term: **14 Years**

(21) Appl. No.: **29/377,359**

(22) Filed: **Oct. 20, 2010**

(51) **LOC (9) Cl.** **12-16**

(52) **U.S. Cl.** **D12/182**

(58) **Field of Classification Search** D12/182,
D12/181, 184-186, 114, 126, 110; 180/219,
180/220, 225; 296/78.1, 192, 193.01, 193.05,
296/193.09, 180.1; 280/304.3, 152.1-152.3,
280/160.1, 848, 852, 847, 849-851

See application file for complete search history.

(56) **References Cited**

U.S. PATENT DOCUMENTS

D57,703 S *	4/1921	Miller	D12/181
D242,340 S	11/1976	Vetter		
D249,784 S	10/1978	Vetter		
D266,159 S	9/1982	Johnson et al.		
D285,427 S *	9/1986	Cline	D12/114
D294,817 S *	3/1988	Preisler	D12/182
D295,277 S *	4/1988	Preisler	D12/182
D521,430 S *	5/2006	Metz	D12/182
D557,181 S	12/2007	Xu		
D597,458 S *	8/2009	Takigawa et al.	D12/182

OTHER PUBLICATIONS

JC Whitney™ 2002 Everything Motorcycle catalog, Side Wings on p. 12.*

J & P Cycles® 2008 Keeping the World on 2 Wheels® catalog, Dragon Wing Air Defelctor and Freedom Wing Air Deflector on p. 780.*

Cycle World Apr. 2009, side wind deflector on The New Batwing Fairing, shown on p. 61.*

* cited by examiner

Primary Examiner — Philip S Hyder

Assistant Examiner — Linda G. Brooks

(74) *Attorney, Agent, or Firm* — Richard C. Litman

(57) **CLAIM**

The ornamental design for a motorcycle fairing extension, as shown and described.

DESCRIPTION

FIG. 1 is an environmental perspective view of a motorcycle fairing extension showing my new design; FIG. 2 is a front elevational view thereof; FIG. 3 is a rear elevational view thereof; FIG. 4 is a left side elevational view thereof; FIG. 5 is a right side elevational view thereof; FIG. 6 is a top view thereof; and, FIG. 7 is a bottom view thereof.

The broken line showing of the motorcycle is for illustrative purposes only and forms no part of the claimed design.

1 Claim, 5 Drawing Sheets

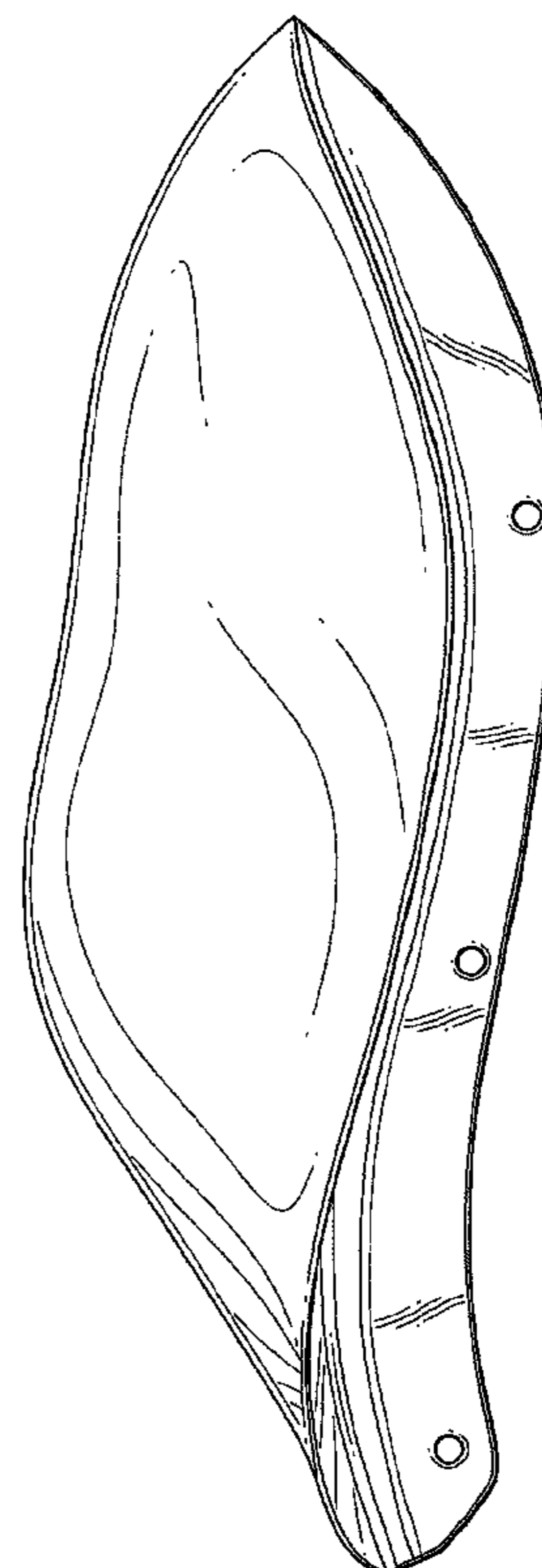
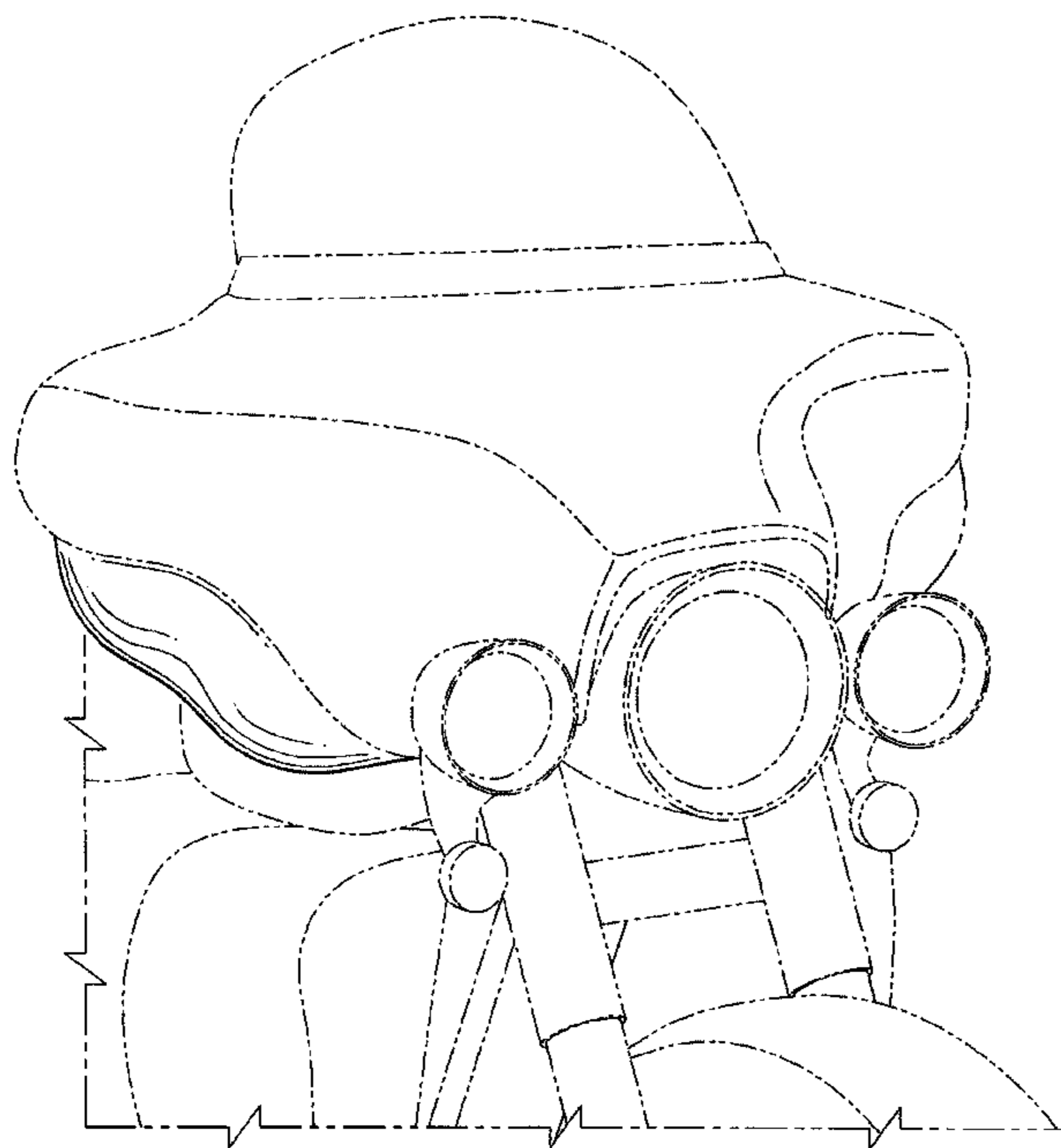

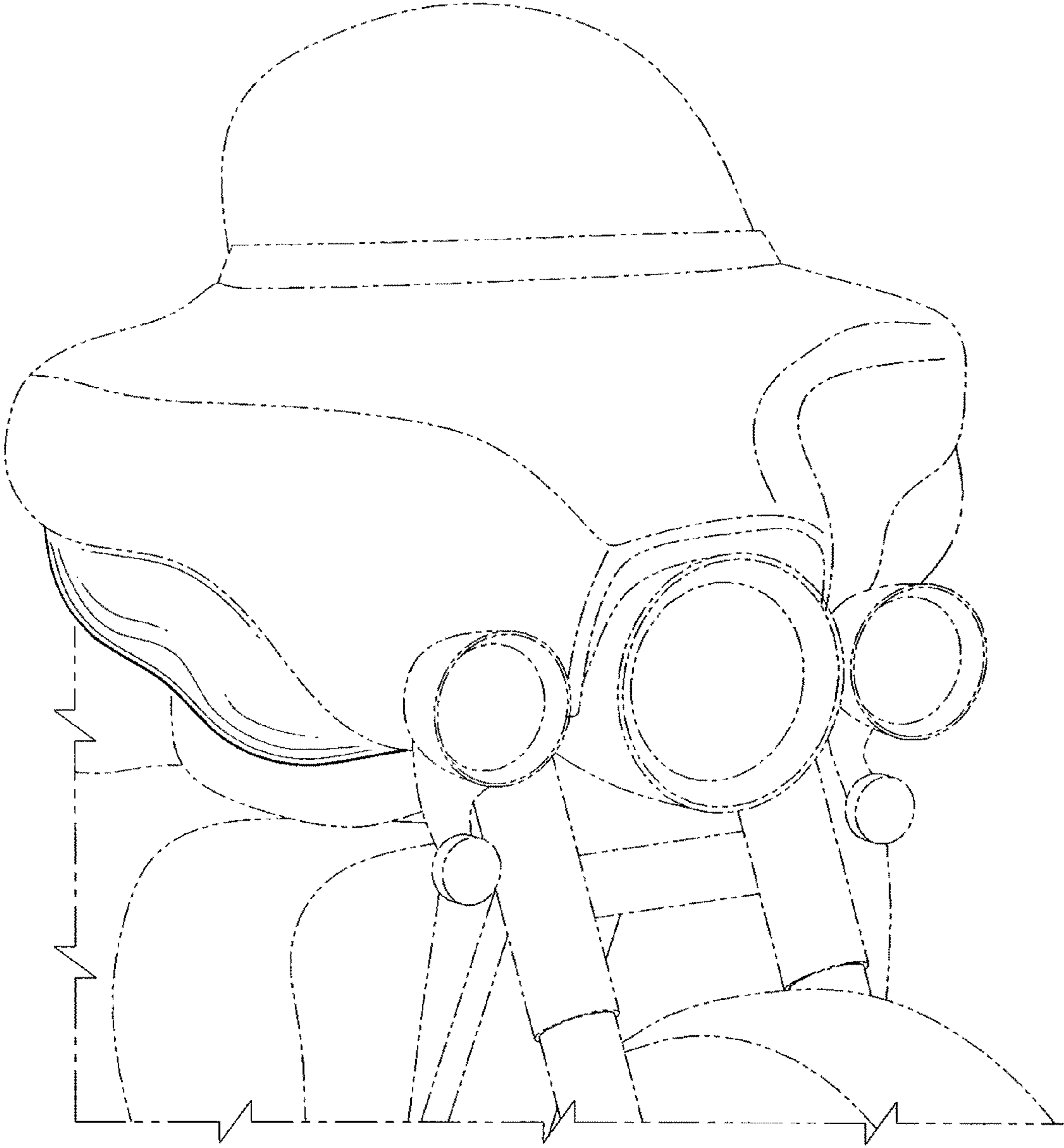

Fig. 1

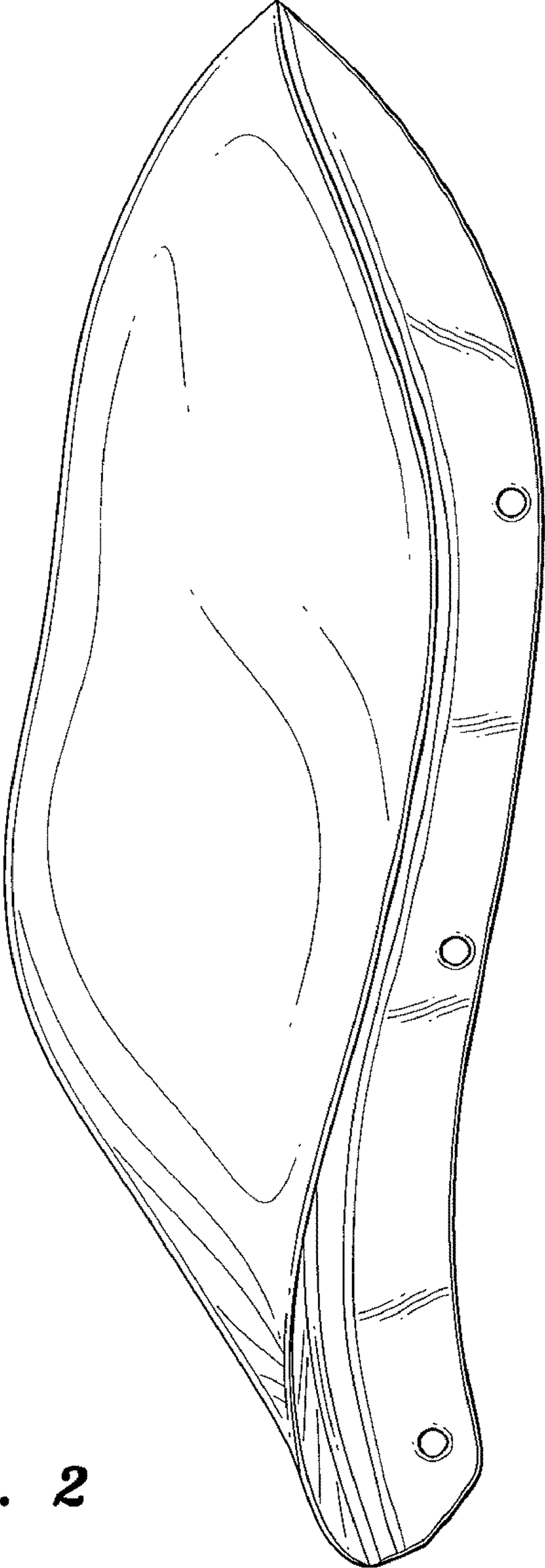

Fig. 2

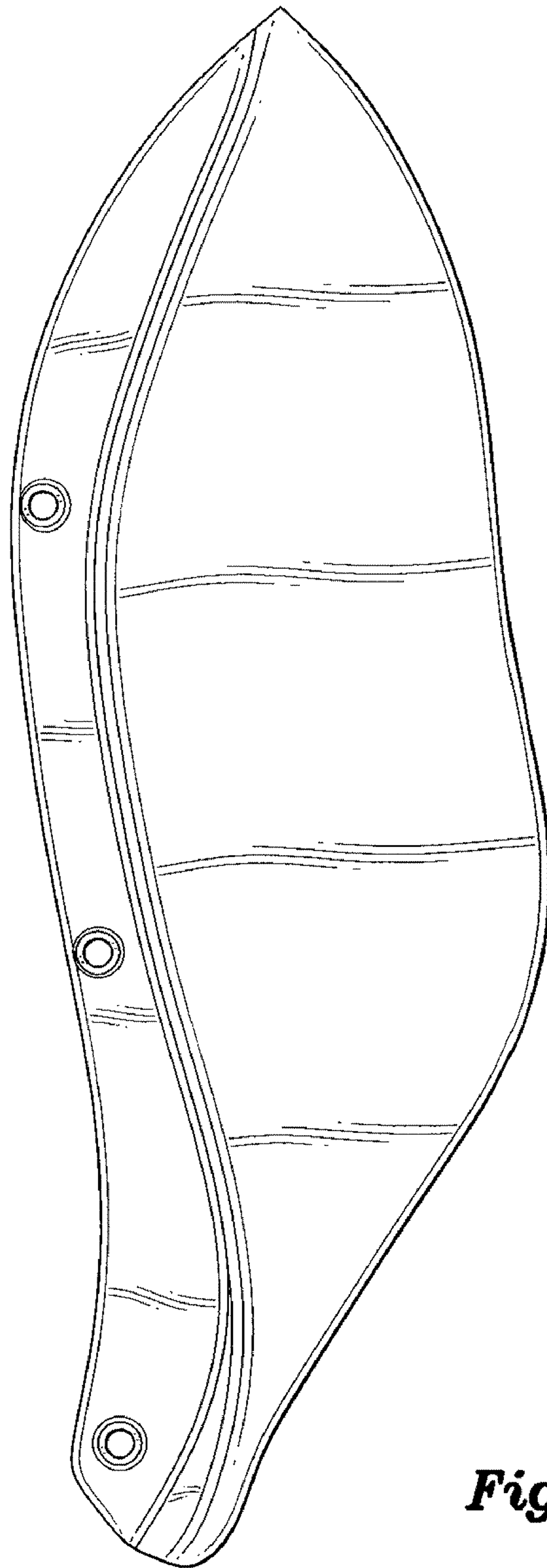

Fig. 3

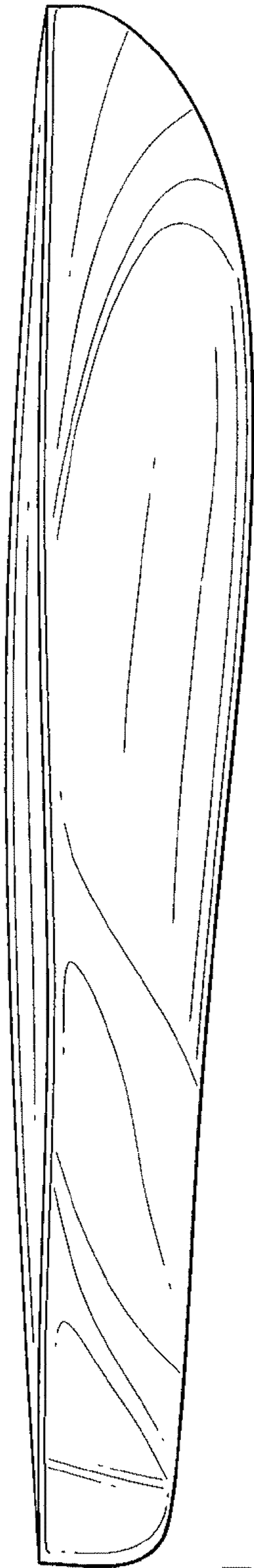

Fig. 4

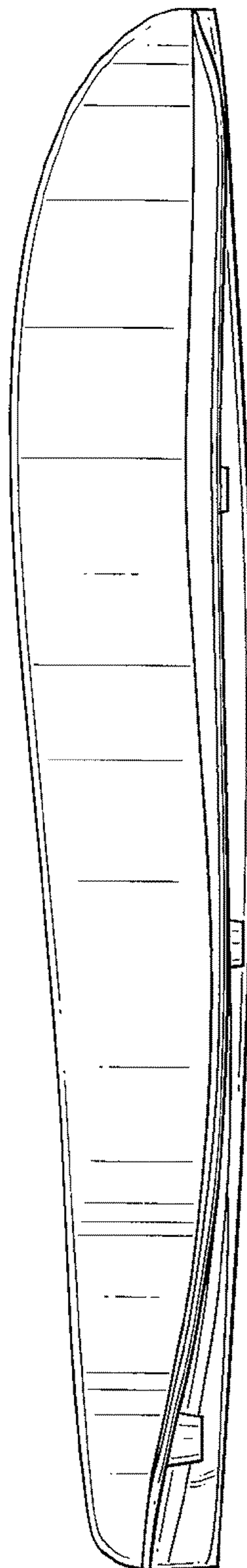

Fig. 5

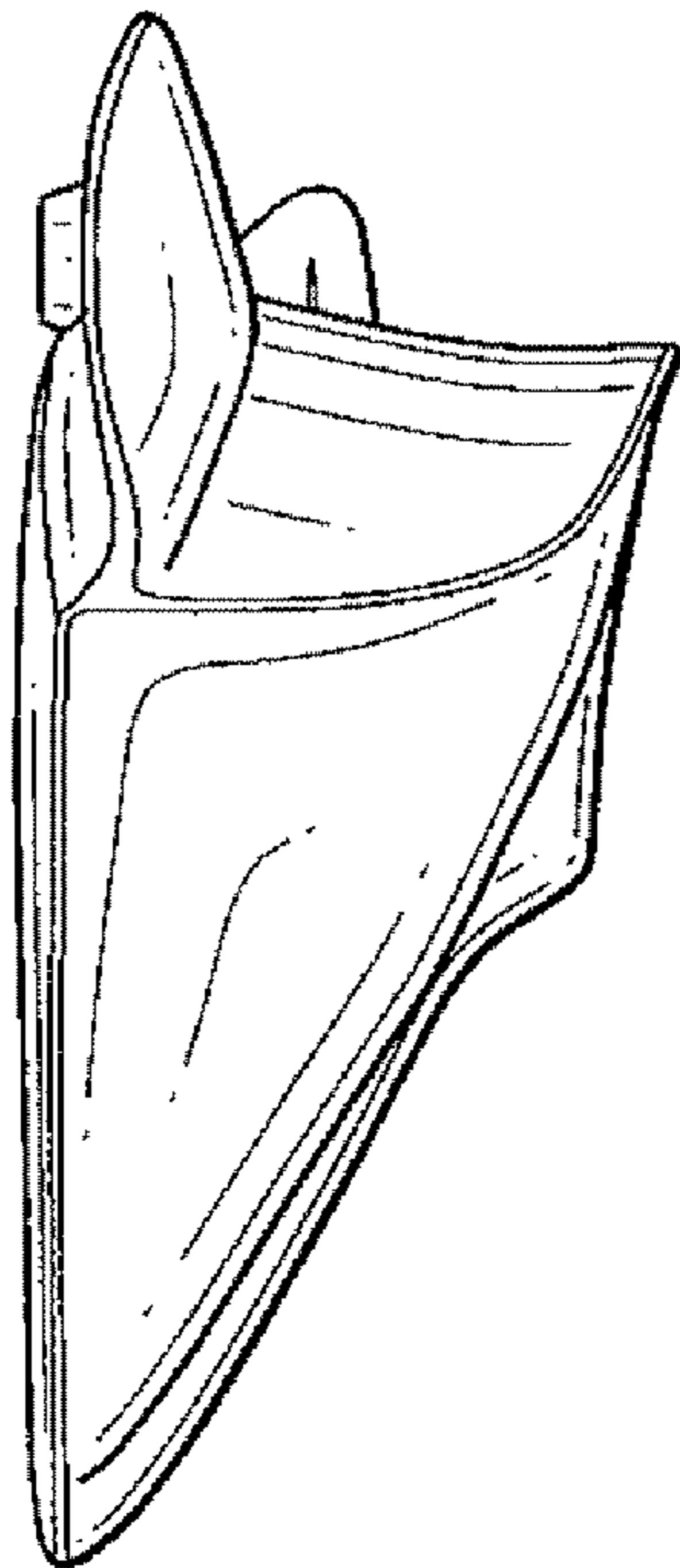

Fig. 6

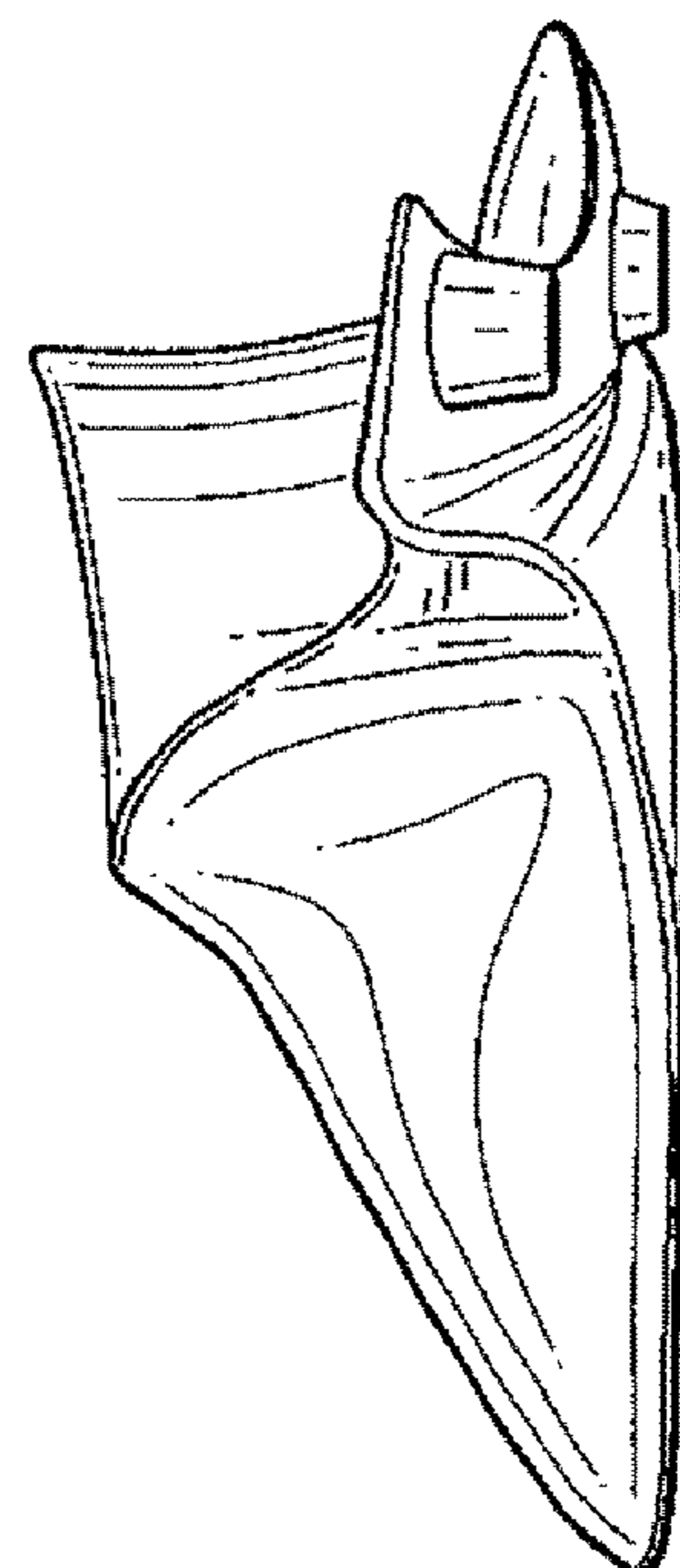

Fig. 7