

US00D634599S

(12) **United States Design Patent**  
**Good**

(10) **Patent No.:** **US D634,599 S**

(45) **Date of Patent:** **\*\* Mar. 22, 2011**

(54) **ARTICULATING NAIL PULLER**

(75) Inventor: **Mark Good**, Cary, IL (US)

(73) Assignee: **Sears Brands, L.L.C.**, Hoffman Estates, IL (US)

(\*\*) Term: **14 Years**

(21) Appl. No.: **29/377,726**

(22) Filed: **Oct. 25, 2010**

**Related U.S. Application Data**

(63) Continuation of application No. 29/345,630, filed on Oct. 20, 2009, now abandoned.

(51) **LOC (9) Cl.** ..... **08-05**

(52) **U.S. Cl.** ..... **D8/89**

(58) **Field of Classification Search** ..... D8/26,  
D8/81, 88-89, 105; 7/146-147, 166; 254/18-19,  
254/21-22, 25, 121, 131

See application file for complete search history.

(56) **References Cited**

**U.S. PATENT DOCUMENTS**

795,876	A *	8/1905	Willhide	254/25
1,554,663	A *	9/1925	Squires	254/19
1,709,240	A *	4/1929	Wass	254/25
2,856,153	A *	10/1958	Crabbs	254/22
3,049,337	A *	8/1962	Griggs	254/131
5,033,140	A *	7/1991	Chen et al.	7/127
5,871,204	A *	2/1999	Spirer	254/26 R
6,314,599	B1 *	11/2001	Hay	7/117
6,629,684	B2 *	10/2003	Youngren et al.	254/19
6,986,504	B1 *	1/2006	Eby et al.	254/25
7,025,331	B2 *	4/2006	Whelan	254/25
7,438,279	B2 *	10/2008	Eby et al.	254/25

D593,835	S *	6/2009	Good	D8/89
7,628,382	B2 *	12/2009	Cole	254/25
D611,788	S	3/2010	Evans et al.	
D618,978	S *	7/2010	Nolle	D8/89
2005/0062025	A1 *	3/2005	Forrester	254/22
2010/0207081	A1 *	8/2010	Liou	254/129
2010/0207082	A1 *	8/2010	Liou	254/131
2010/0314593	A1 *	12/2010	Fan	254/25

**OTHER PUBLICATIONS**

Gear Wrench Indexing Nail Puller. Downloaded Jul. 15, 2010 at [http://www.sears.com/shc/s/p\\_10153\\_12605\\_00982717000P?prdNo=24&blockNo=24&blockTyp...\\*](http://www.sears.com/shc/s/p_10153_12605_00982717000P?prdNo=24&blockNo=24&blockTyp...)

\* cited by examiner

*Primary Examiner* — Philip S Hyder

*Assistant Examiner* — Roselynn Cody

(74) *Attorney, Agent, or Firm* — Greenberg Traurig, LLP

(57) **CLAIM**

What is claimed is the ornamental design for an articulating nail puller, as shown and described.

**DESCRIPTION**

FIG. 1 is a perspective view of an articulating nail puller showing my new design;

FIG. 2 is a left side elevational view thereof, the right side elevational view being a mirror image;

FIG. 3 is a top plan view thereof;

FIG. 4 is a bottom plan view thereof;

FIG. 5 is a front elevational view thereof; and,

FIG. 6 is a rear elevational view thereof.

The dotted lines showing the articulating nail puller shaft and pivoting mechanism are provided for illustrative purposes only and form no part of the design claimed.

**1 Claim, 4 Drawing Sheets**

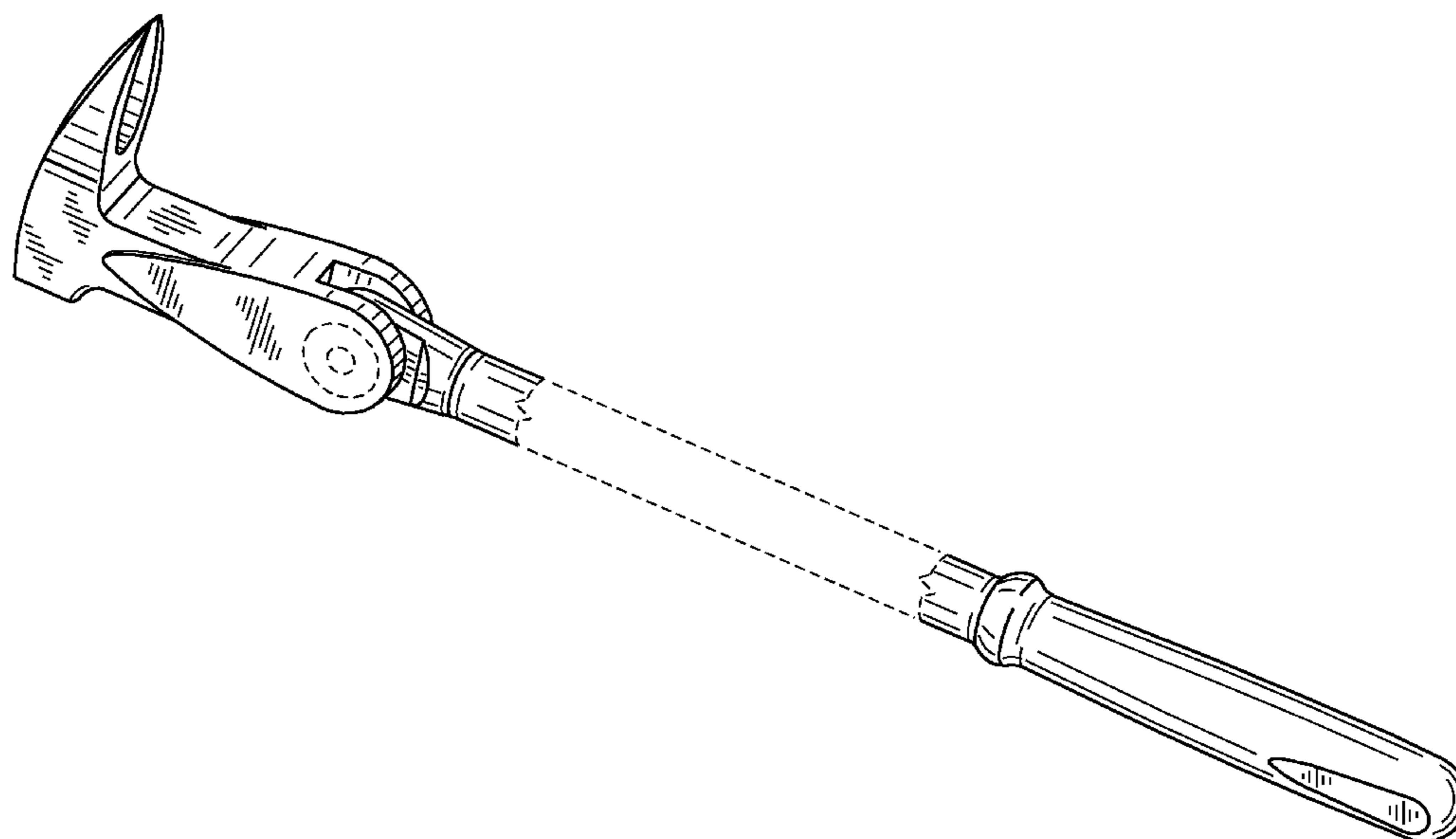

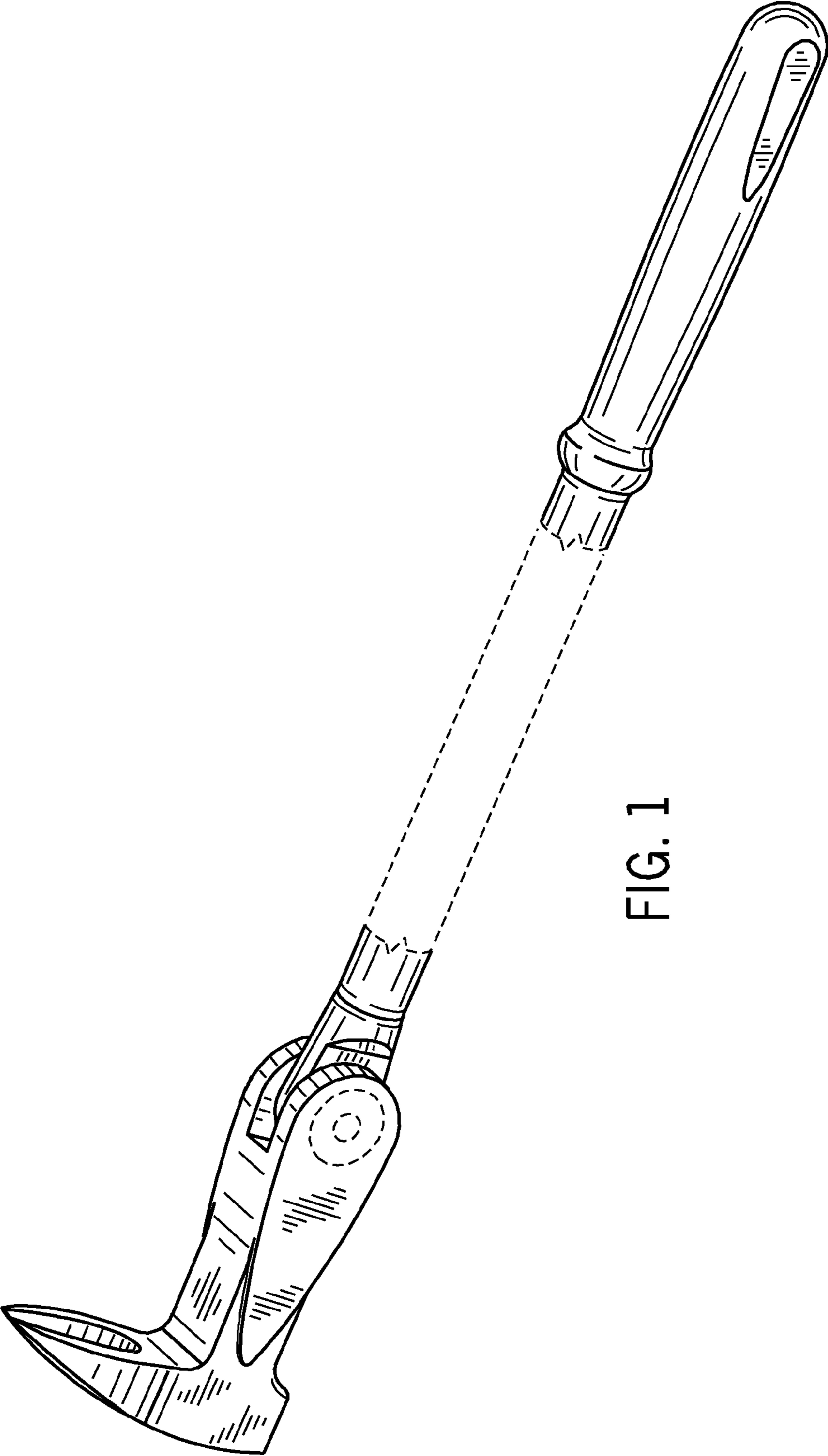

FIG. 1

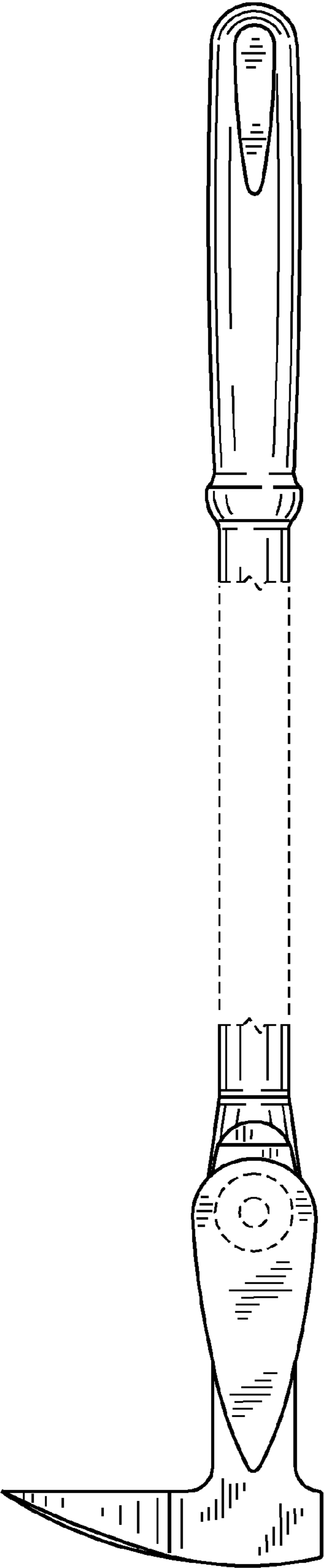

FIG. 2

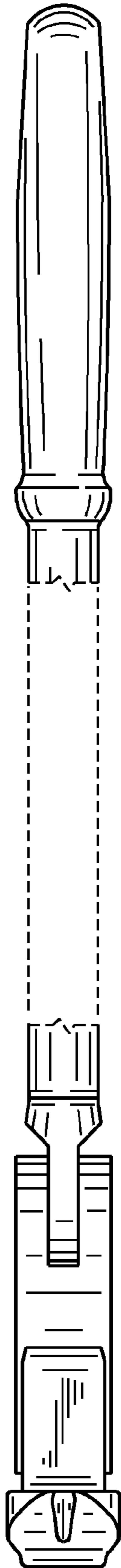

FIG. 3

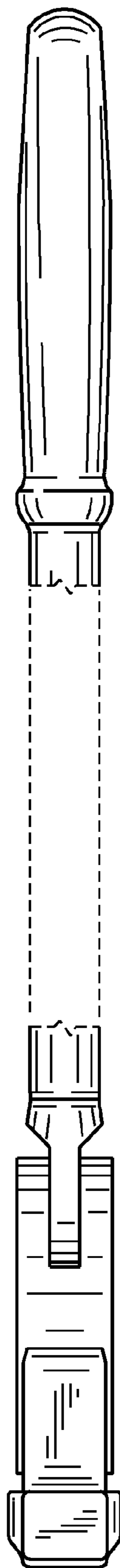

FIG. 4

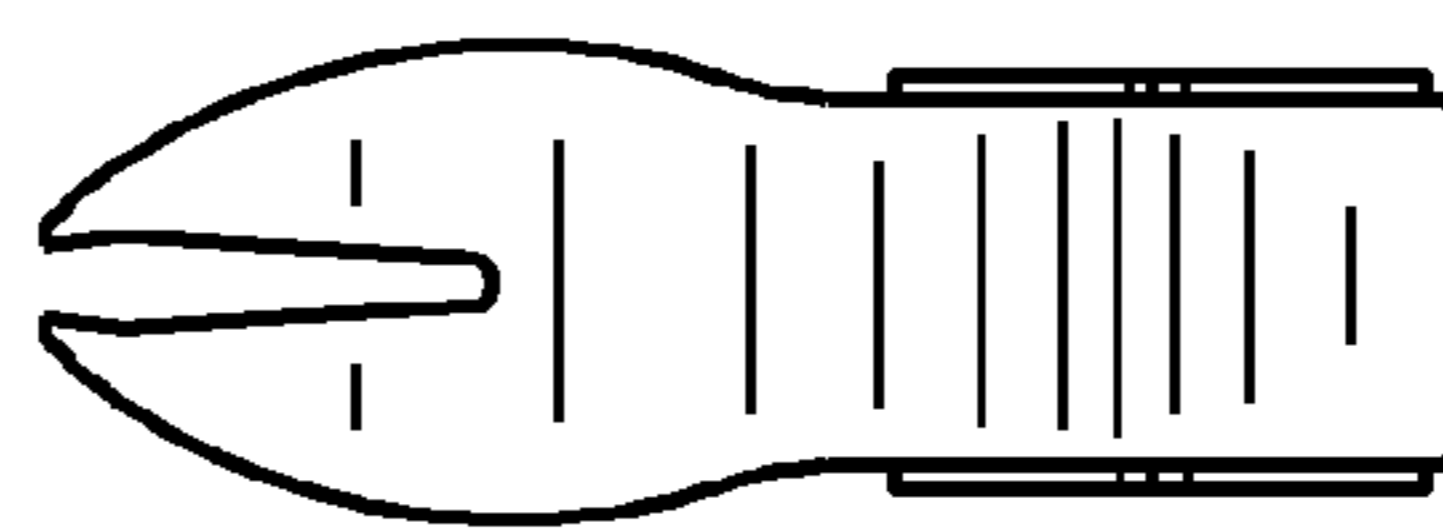

FIG. 6

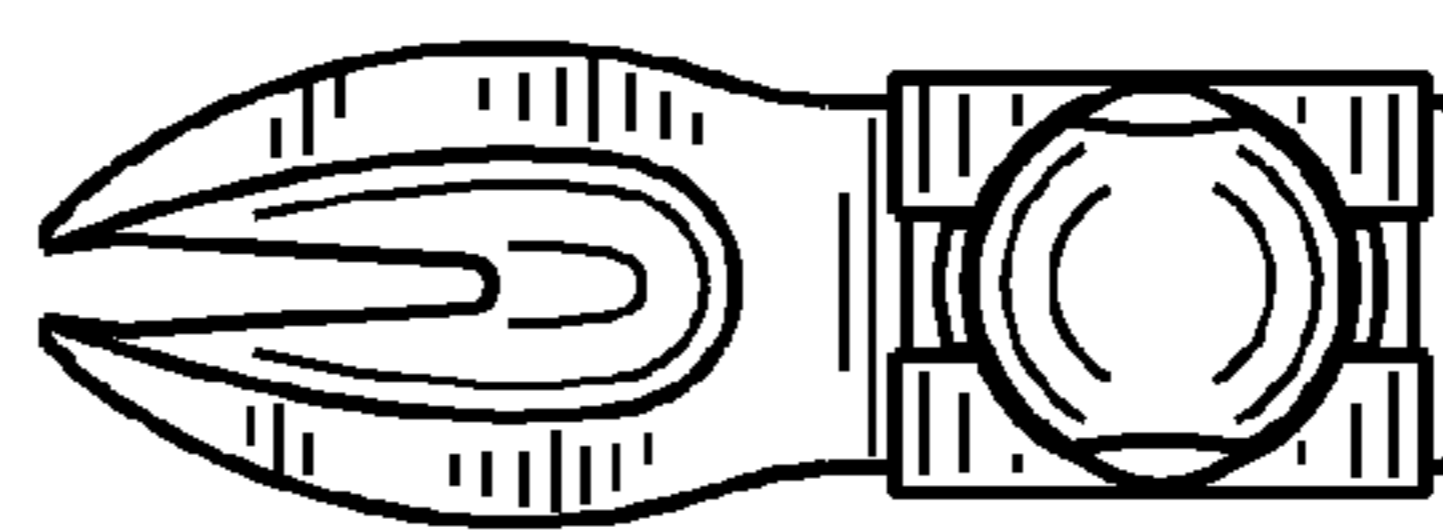

FIG. 5