



US00D634437S

(12) **United States Design Patent**
Gramza et al.

(10) **Patent No.:** **US D634,437 S**
(45) **Date of Patent:** **** Mar. 15, 2011**

(54) **KNEE BRACE**

(75) Inventors: **Beth E. Gramza**, Cincinnati, OH (US);
Sherry A. Hinds, Goshen, OH (US);
Jeffrey P. Krauser, Cincinnati, OH (US)

(73) Assignee: **3M Innovative Properties Company**,
St. Paul, MN (US)

(**) Term: **14 Years**

(21) Appl. No.: **29/340,141**

(22) Filed: **Jul. 14, 2009**

(51) **LOC (9) Cl.** **24-01**

(52) **U.S. Cl.** **D24/190**

(58) **Field of Classification Search** D24/190,
D24/189, 200, 206; D29/121.1; 602/26,
602/5, 16, 60, 62, 63; 2/22, 24, 455, 456;
607/112; 128/892

See application file for complete search history.

(56) **References Cited**

U.S. PATENT DOCUMENTS

D259,058	S	*	4/1981	Marshall	D24/190
4,370,978	A	*	2/1983	Palumbo	602/26
D273,420	S	*	4/1984	Gruber	D24/190
5,139,476	A	*	8/1992	Peters	602/26
5,451,201	A	*	9/1995	Prengler	602/26
5,462,517	A	*	10/1995	Mann	602/26
5,823,981	A	*	10/1998	Grim et al.	602/26
D403,424	S	*	12/1998	Taylor et al.	D24/190
5,865,777	A	*	2/1999	Detty	602/26
D444,563	S	*	7/2001	Rodgers	D24/190

6,528,697	B1	*	3/2003	Knutson et al.	602/54
D501,927	S	*	2/2005	McCormick et al.	D24/190
D510,140	S	*	9/2005	Brown	D24/200
D533,668	S	*	12/2006	Brown	D24/200
D618,358	S	*	6/2010	Avitable et al.	D24/190
D618,812	S	*	6/2010	Beckwith et al.	D24/190
D619,267	S	*	7/2010	Beckwith et al.	D24/190
7,749,182	B2	*	7/2010	Gramza et al.	602/26
2005/0020951	A1	*	1/2005	Gaylord et al.	602/26
2008/0195012	A1	*	8/2008	Miros et al.	602/26

* cited by examiner

Primary Examiner — Susan E Krakower

(74) *Attorney, Agent, or Firm* — Lisa P. Fulton

(57) **CLAIM**

The ornamental design for a knee brace, as shown and described.

DESCRIPTION

FIG. 1 is a perspective view of a knee brace showing our new design in open condition;

FIG. 2 is an enlarged perspective view thereof in a closed condition;

FIG. 3 is a top view thereof;

FIG. 4 is a bottom view thereof;

FIG. 5 is an end view thereof, as taken from the top of FIG. 3;

FIG. 6 is an end view thereof, as taken from the bottom of FIG. 2;

FIG. 7 is a end view thereof, as taken from the left side of FIG. 2; and,

FIG. 8 is an end view thereof, as taken from the right side of FIG. 2.

1 Claim, 2 Drawing Sheets

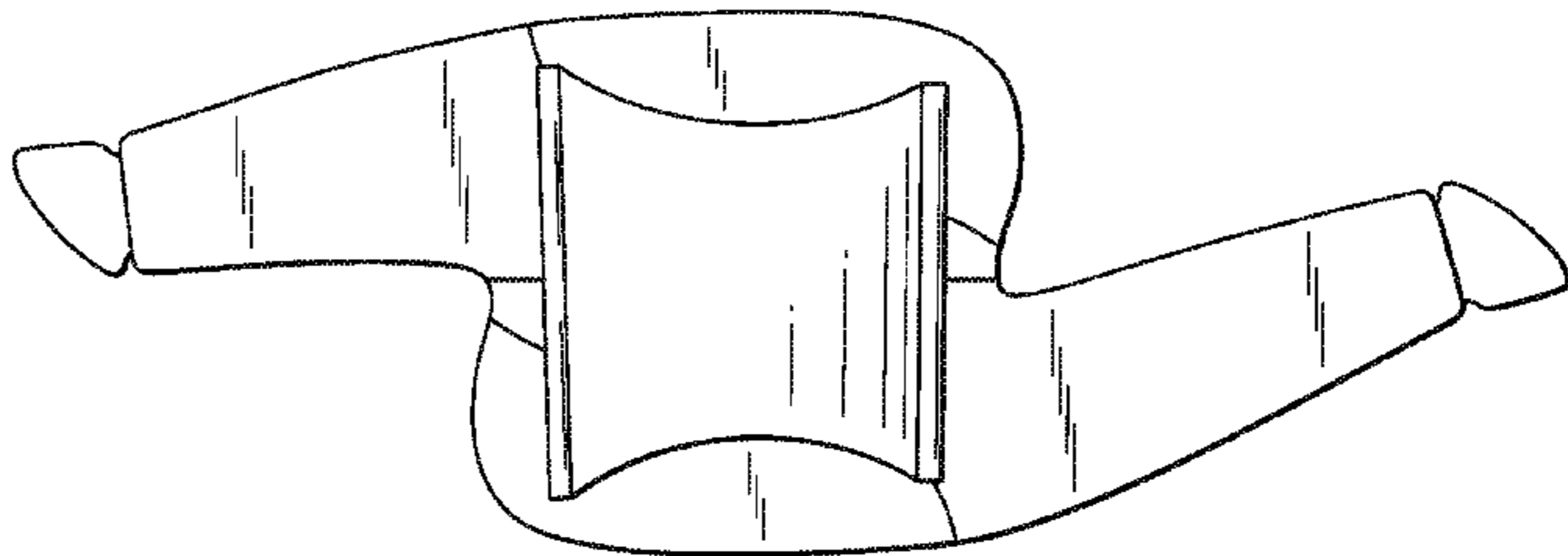
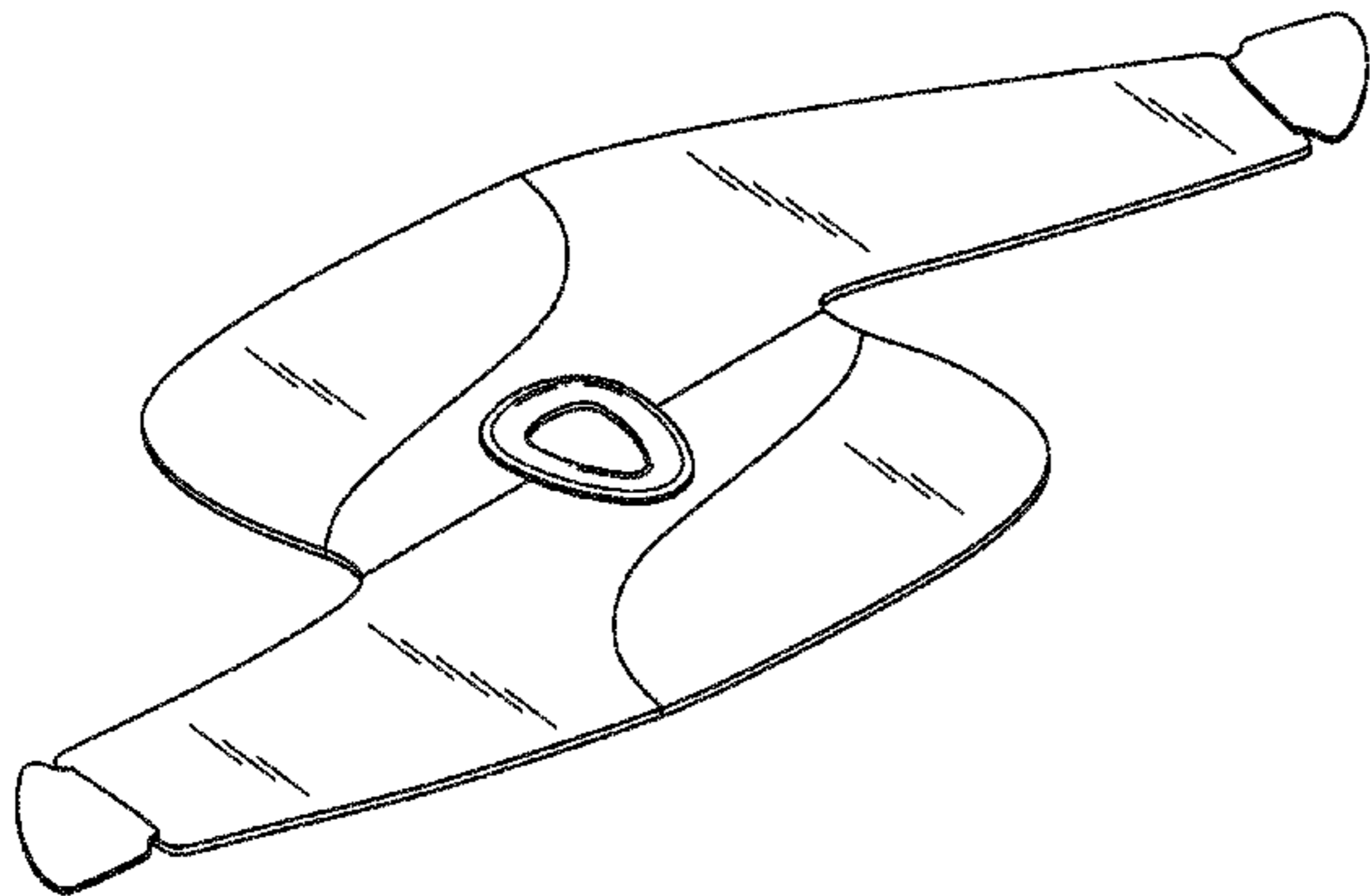

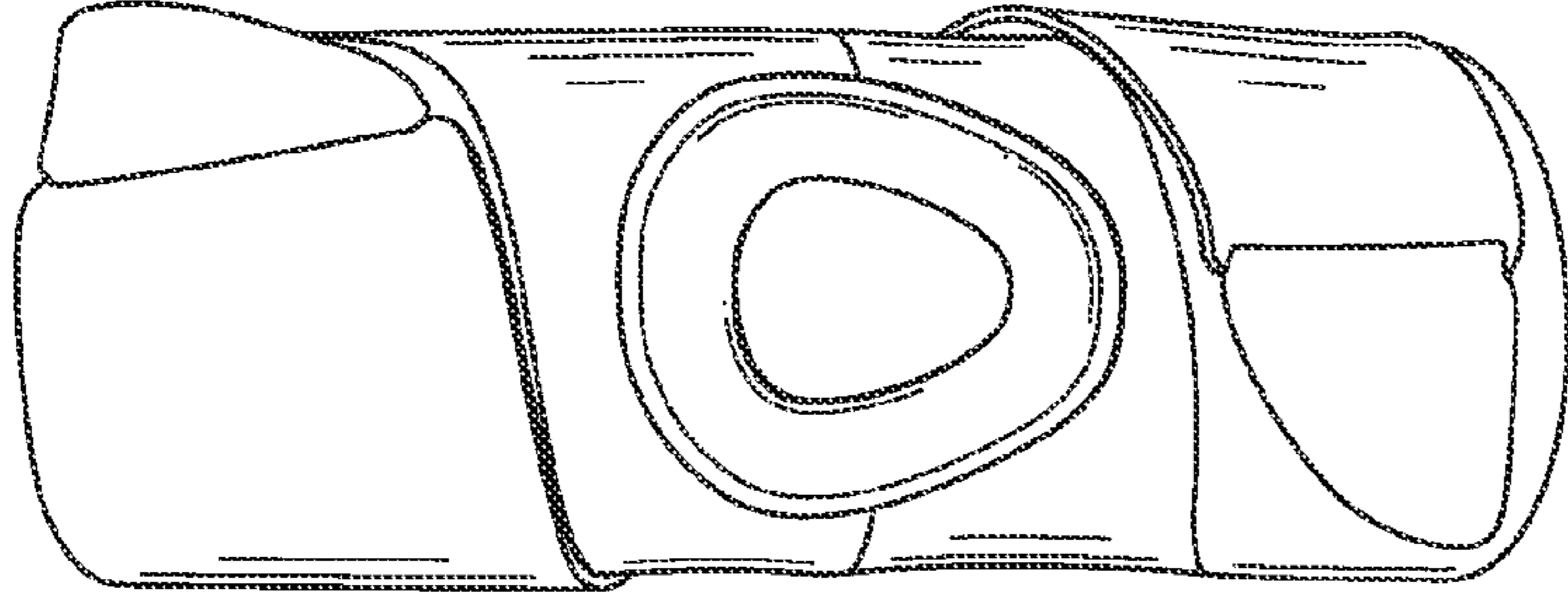

FIG. 2

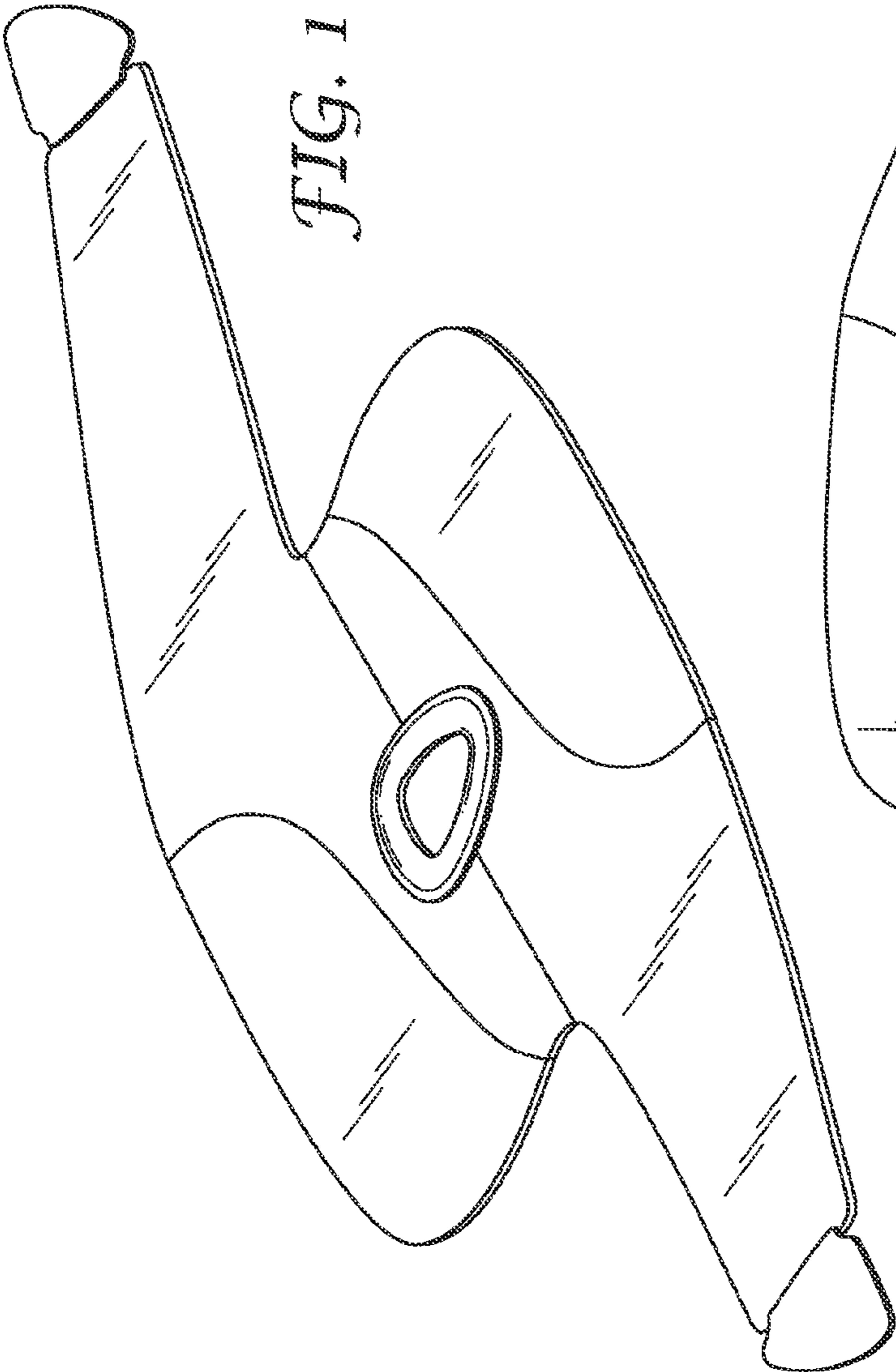

FIG. 1

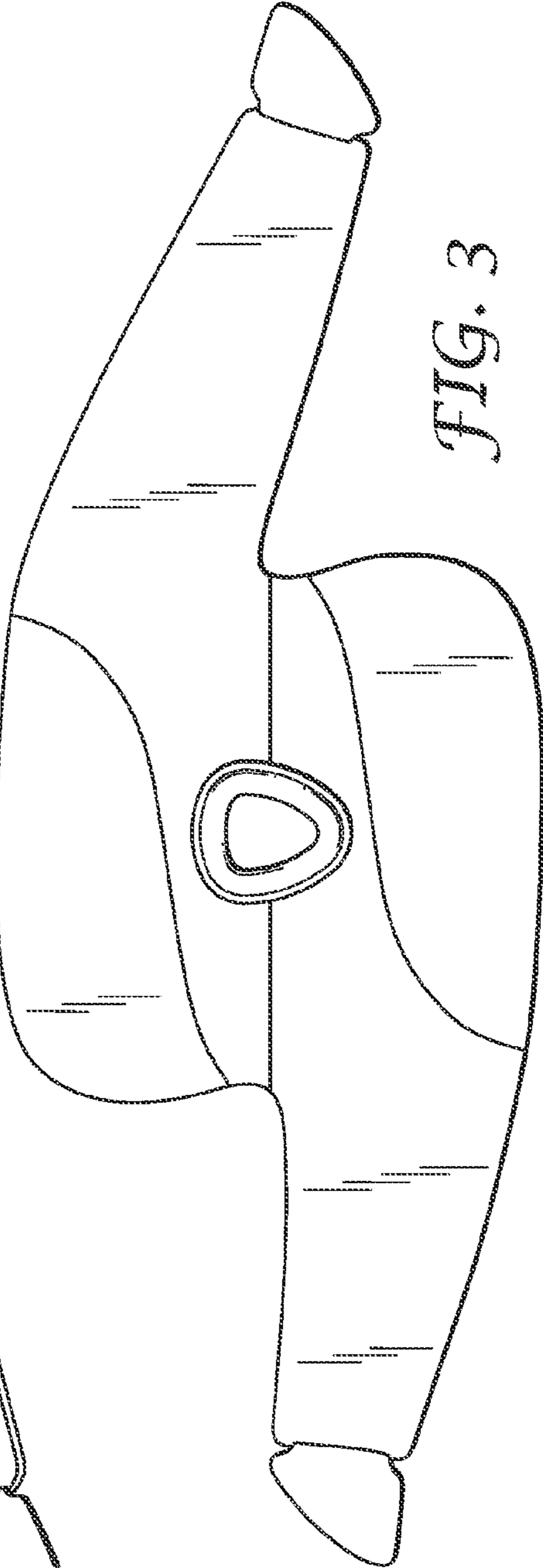

FIG. 3

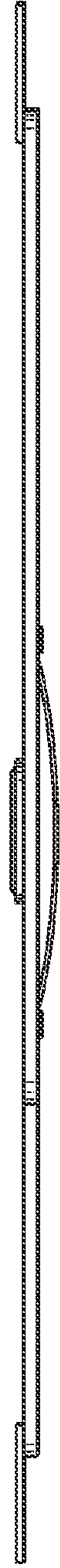
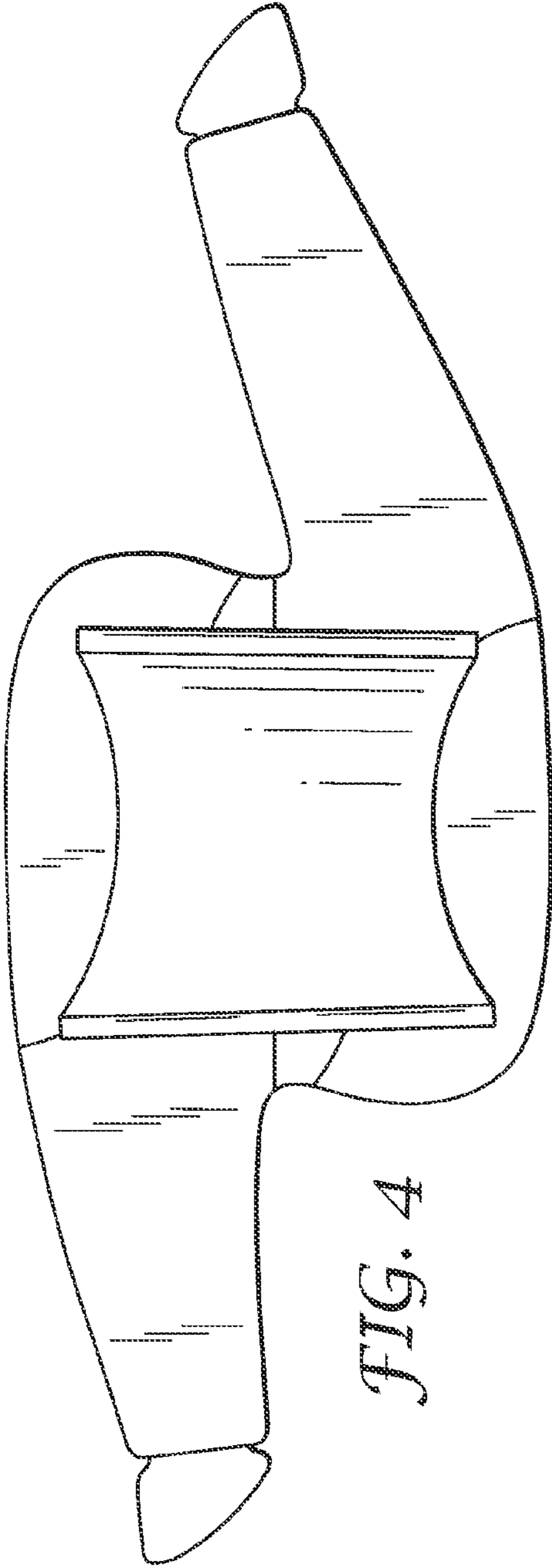

FIG. 5



FIG. 6



FIG. 7



FIG. 8