



US00D634413S

(12) **United States Design Patent**
Wallace

(10) **Patent No.:** **US D634,413 S**
(45) **Date of Patent:** **** Mar. 15, 2011**

(54) **AIR CONDITIONER UNIT SCREENING
DEVICE**

(76) Inventor: **Martha L. Wallace**, Fontana, CA (US)

(**) Term: **14 Years**

(21) Appl. No.: **29/356,506**

(22) Filed: **Feb. 26, 2010**

(51) **LOC (9) Cl.** **23-04**

(52) **U.S. Cl.** **D23/354; D25/53; D23/386**

(58) **Field of Classification Search** D23/351-354,
D23/314, 333, 341, 386; D30/108; D6/610;
D25/53; 52/73, 664; 150/165; 454/202,
454/204, 224; 62/262; 119/452, 484

See application file for complete search history.

(56) **References Cited**

U.S. PATENT DOCUMENTS

| | | | | | |
|-----------|-----|---------|-----------|-------|---------|
| 2,213,192 | A * | 9/1940 | Kaufman | | 52/73 |
| 2,705,990 | A | 4/1955 | Miller | | |
| 3,011,424 | A * | 12/1961 | Kohnen | | D23/354 |
| 3,320,996 | A | 5/1967 | Singer | | |
| 3,436,889 | A | 4/1969 | Jessee | | |
| D246,379 | S | 11/1977 | Mueller | | |
| 4,202,389 | A | 5/1980 | Ewald | | |
| 4,445,459 | A * | 5/1984 | Julie | | 119/484 |
| D275,703 | S * | 9/1984 | De Rocher | | D25/53 |
| D283,182 | S * | 4/1986 | Marshall | | D30/108 |

| | | | | | |
|-----------|-----|---------|-----------------|-------|---------|
| 4,625,784 | A | 12/1986 | Boroson | | |
| 4,759,194 | A | 7/1988 | Shapiro | | |
| 4,989,546 | A * | 2/1991 | Cannaday | | 119/484 |
| 5,156,662 | A | 10/1992 | Downing et al. | | |
| 5,167,202 | A * | 12/1992 | Bradford et al. | | 119/484 |
| D348,793 | S * | 7/1994 | Herrick | | D6/610 |
| 5,529,593 | A | 6/1996 | Simmons | | |
| D425,188 | S * | 5/2000 | Garcia | | D23/354 |
| 7,387,654 | B1 | 6/2008 | Byers | | |

* cited by examiner

Primary Examiner — Brian N Vinson

(57) **CLAIM**

The ornamental design for an air conditioner unit screening device, as shown and described.

DESCRIPTION

FIG. 1 is a rear elevational view of an air conditioner unit screening device showing my new design; FIG. 2 is a front elevational view thereof; FIG. 3 is a left side elevational view thereof; FIG. 4 is a right side elevational view thereof, with the broken-line disclosure being for illustrative purposes only and forming no part of the claimed design; FIG. 5 is a top plan view thereof; FIG. 6 is a bottom plan view thereof; and, FIG. 7 is a top, front, and right side perspective thereof.

1 Claim, 6 Drawing Sheets

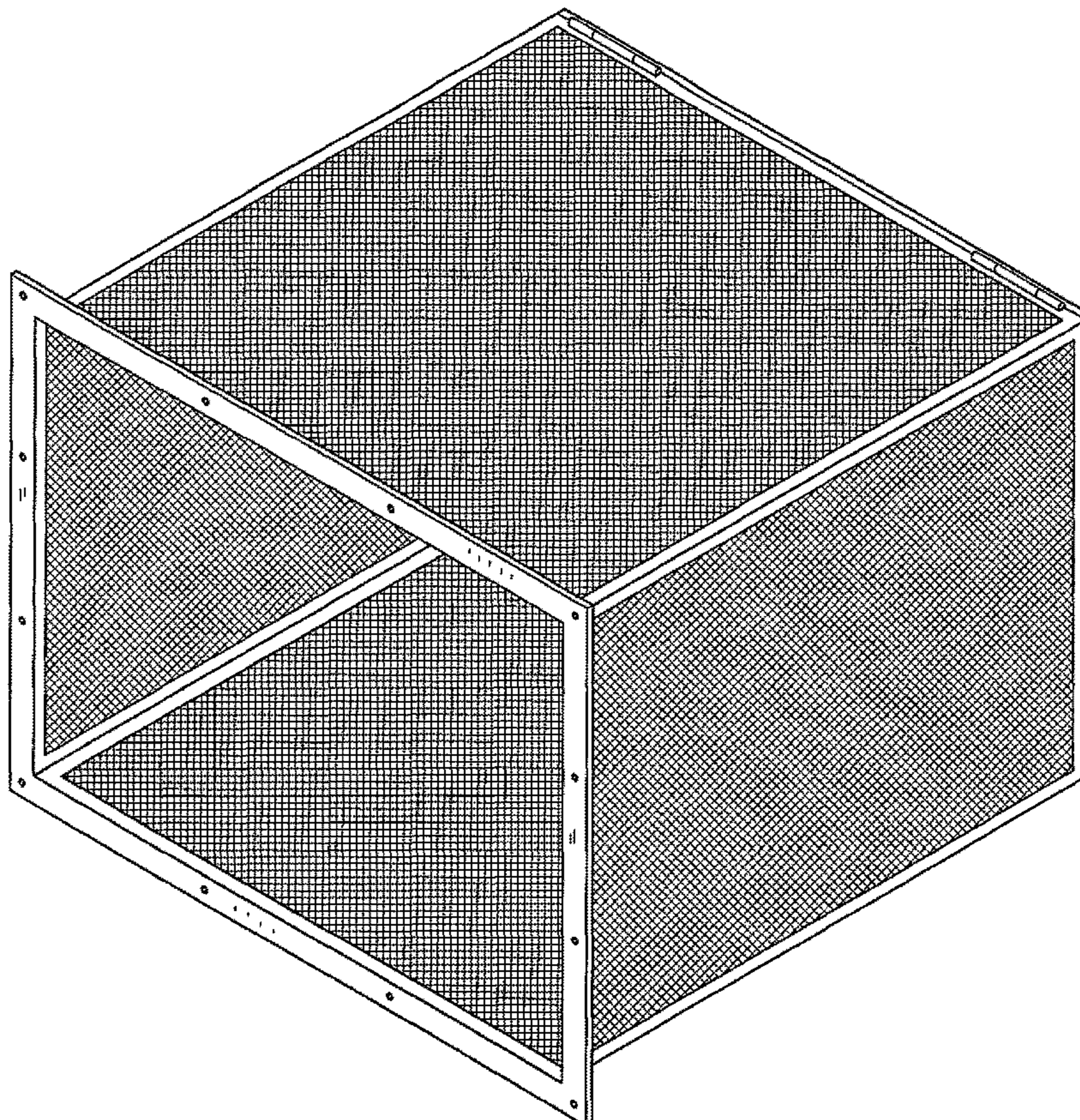

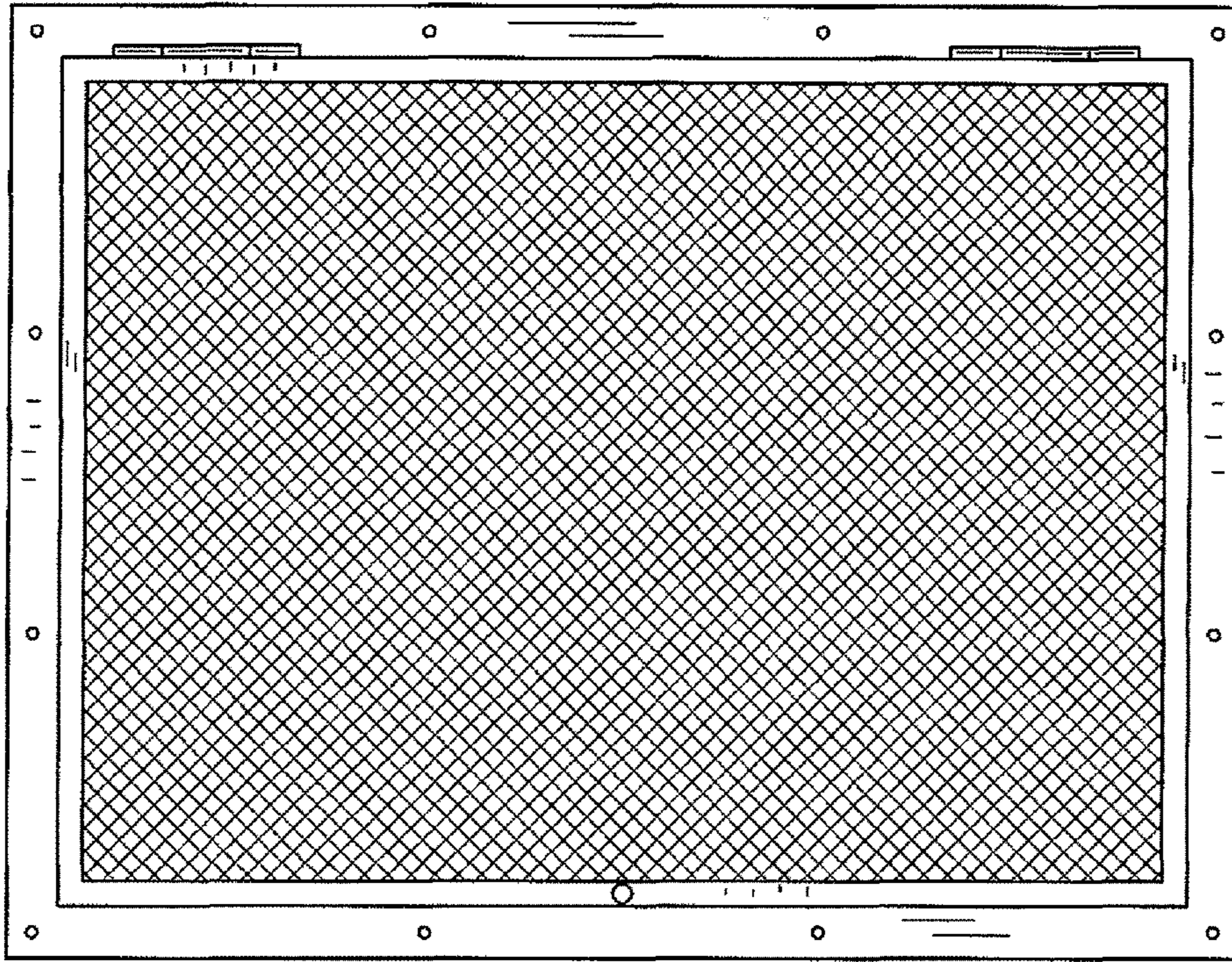

FIG. 1

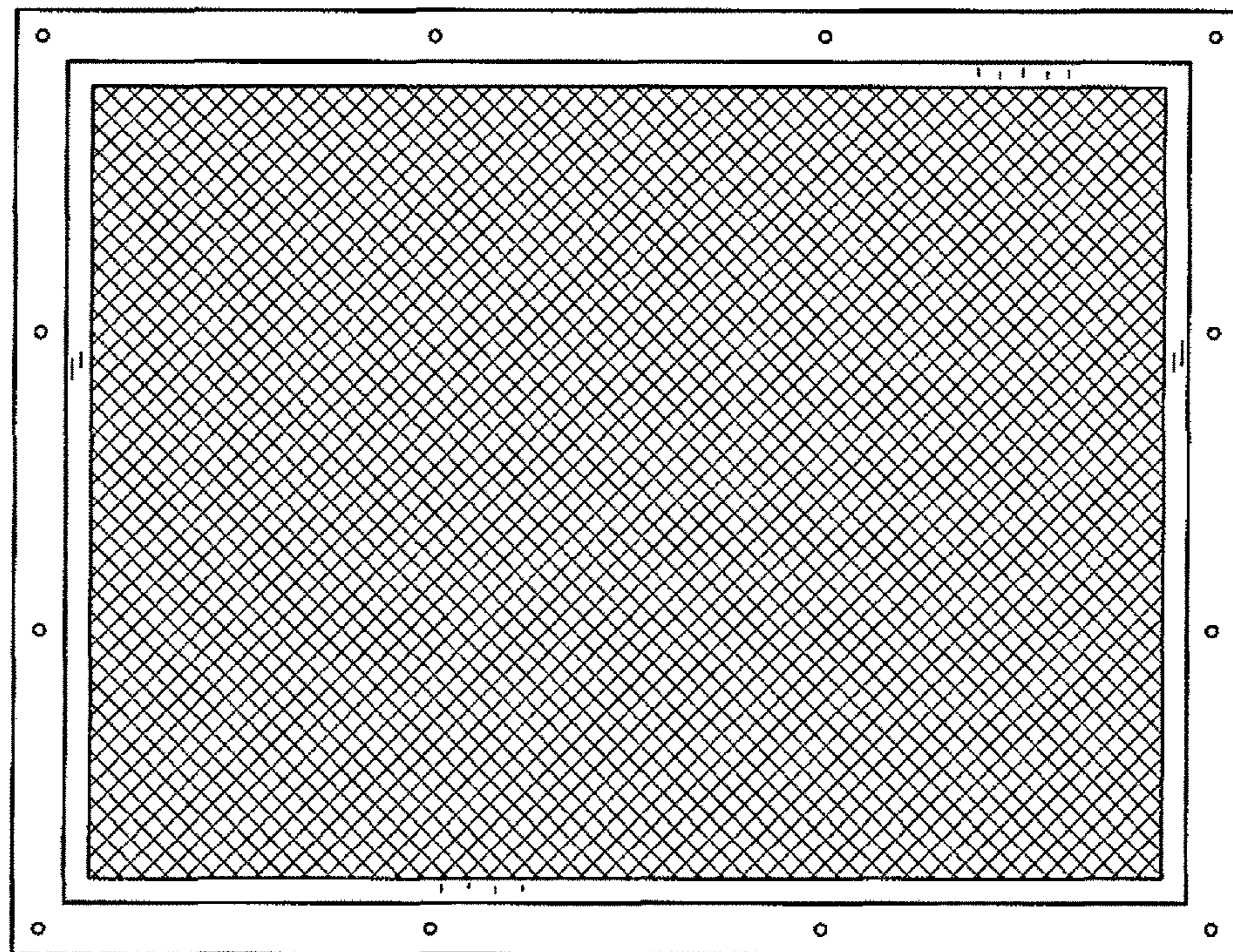

FIG. 2

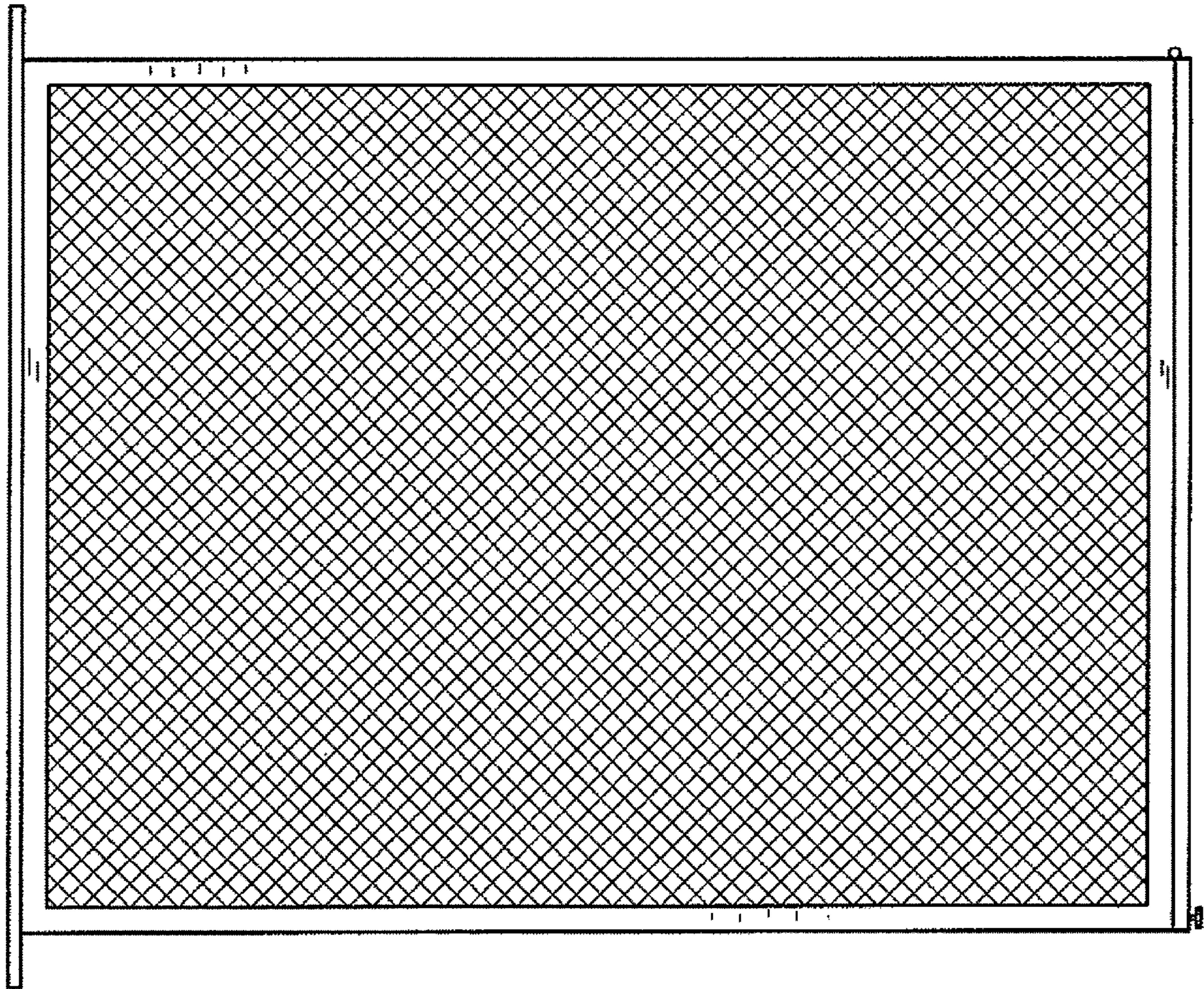

FIG. 3

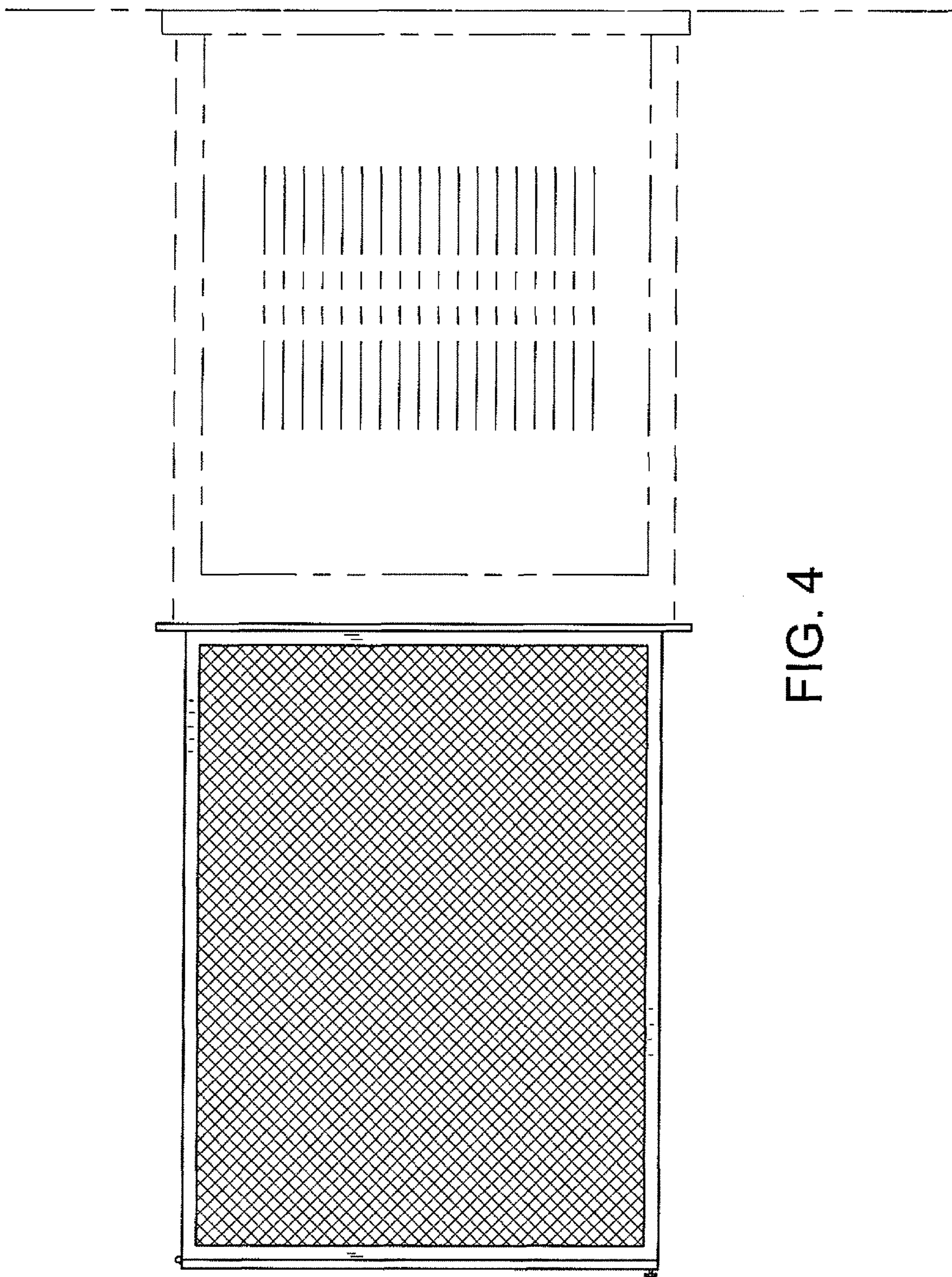

FIG. 4

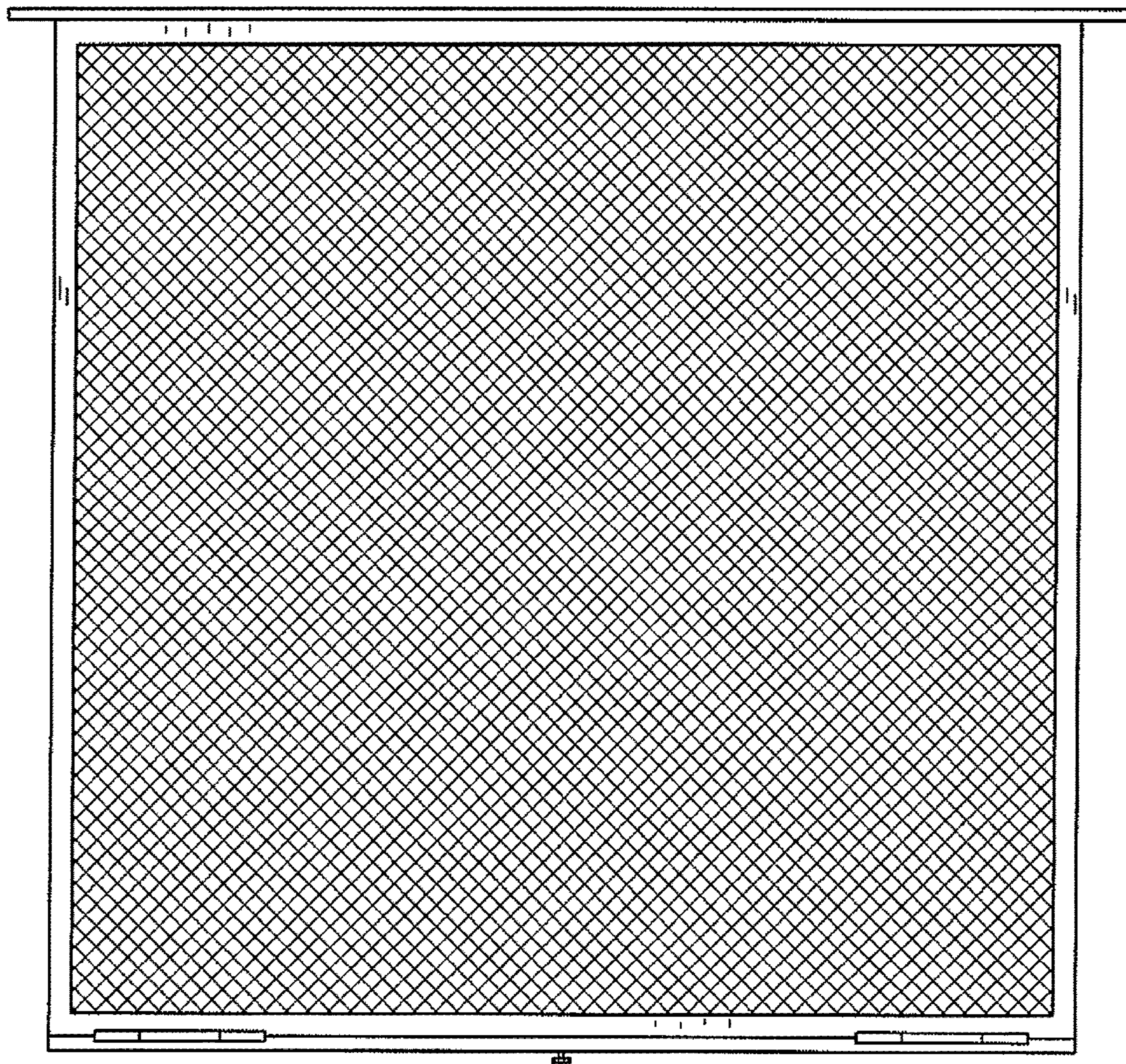

FIG. 5

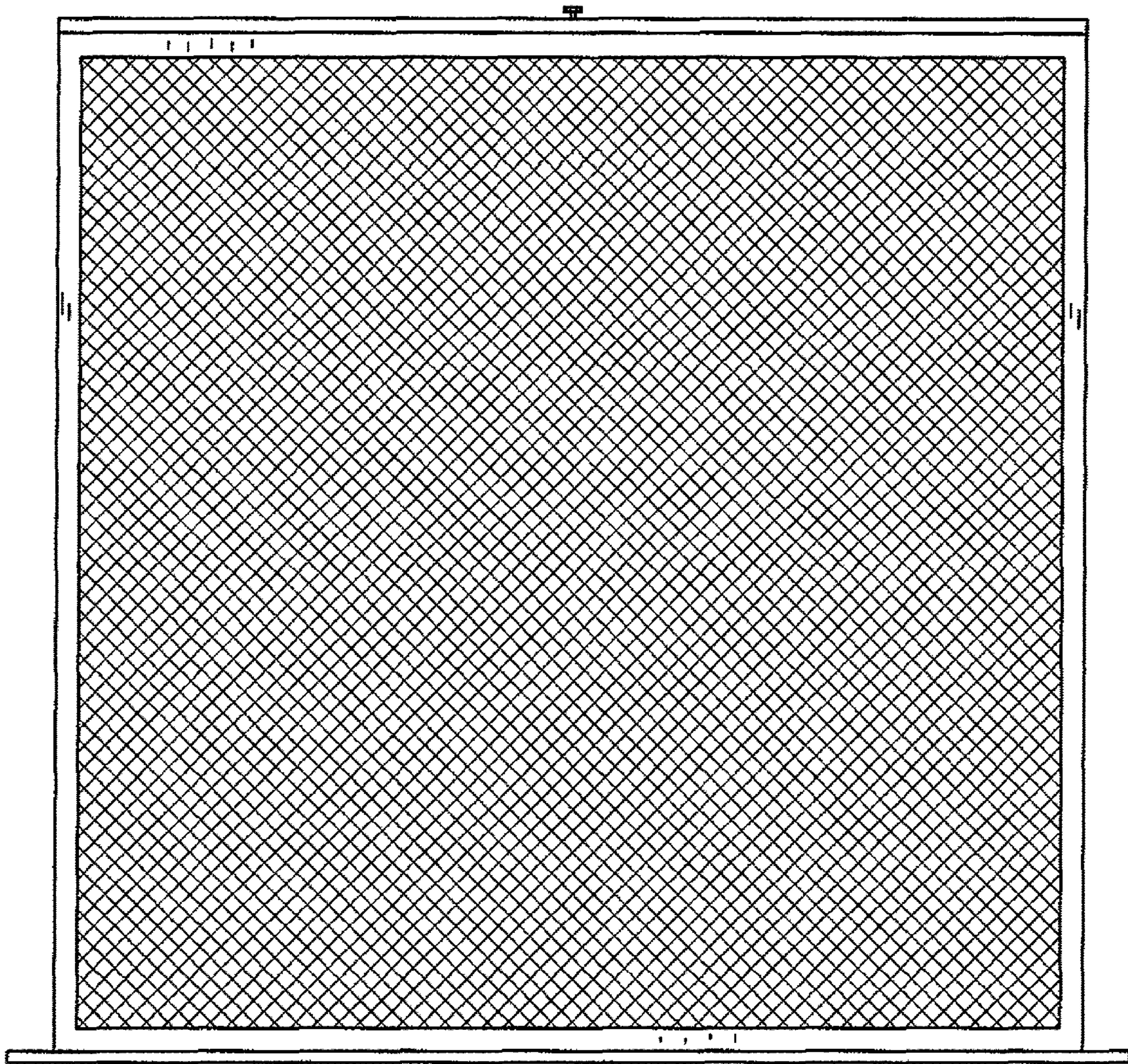

FIG. 6

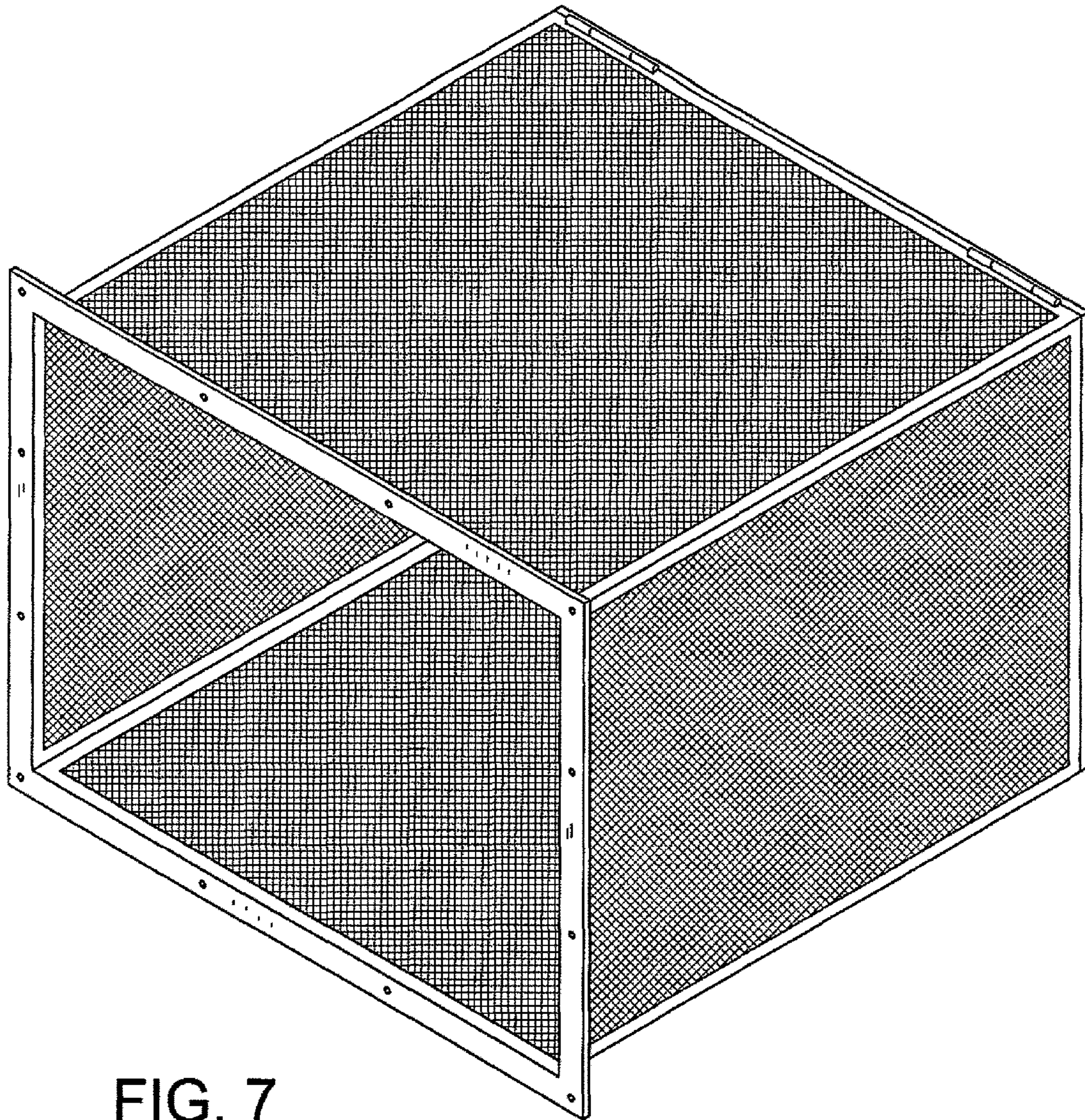

FIG. 7