



US00D634322S

(12) **United States Design Patent**
Chiu

(10) **Patent No.:** **US D634,322 S**

(45) **Date of Patent:** **** Mar. 15, 2011**

(54) **DISPLAY**

(75) **Inventor:** **Yi-Chung Chiu**, Taoyuan County (TW)

(73) **Assignee:** **Hannspree, Inc.**, Taipei County (TW)

(**) **Term:** **14 Years**

(21) **Appl. No.:** **29/365,351**

(22) **Filed:** **Jul. 8, 2010**

(51) **LOC (9) Cl.** **14-02**

(52) **U.S. Cl.** **D14/371**

(58) **Field of Classification Search** D14/371-376,
D14/125-129, 336; D6/300, 304, 308; 345/104,
345/156, 173, 174, 901-905; 348/180, 184,
348/325, 739; 361/679.08, 679.23; 349/1,
349/2, 11, 58; 248/122.1, 278.1; 341/12
See application file for complete search history.

(56) **References Cited**

U.S. PATENT DOCUMENTS

D389,462 S * 1/1998 Johns et al. D14/375
D473,865 S * 4/2003 Zuege et al. D14/371

D538,801 S * 3/2007 Taylor D14/341
7,280,665 B2 * 10/2007 Tamura et al. 381/333
D598,404 S * 8/2009 Arie et al. D14/126
D608,782 S * 1/2010 Chu D14/371

* cited by examiner

Primary Examiner — Freda S Nunn

(74) *Attorney, Agent, or Firm* — Tim Tingkang Xia; Morris,
Manning & Martin, LLP

(57) **CLAIM**

The ornamental design for a “display,” as shown and
described.

DESCRIPTION

FIG. 1. is a perspective view of a “display” of the present
invention;
FIG. 2. is a front elevational view thereof;
FIG. 3. is a rear elevational view thereof;
FIG. 4. is a left side elevational view thereof;
FIG. 5. is a right side elevational view thereof;
FIG. 6. is a top plan view thereof; and,
FIG. 7. is a bottom plan view thereof.

1 Claim, 7 Drawing Sheets

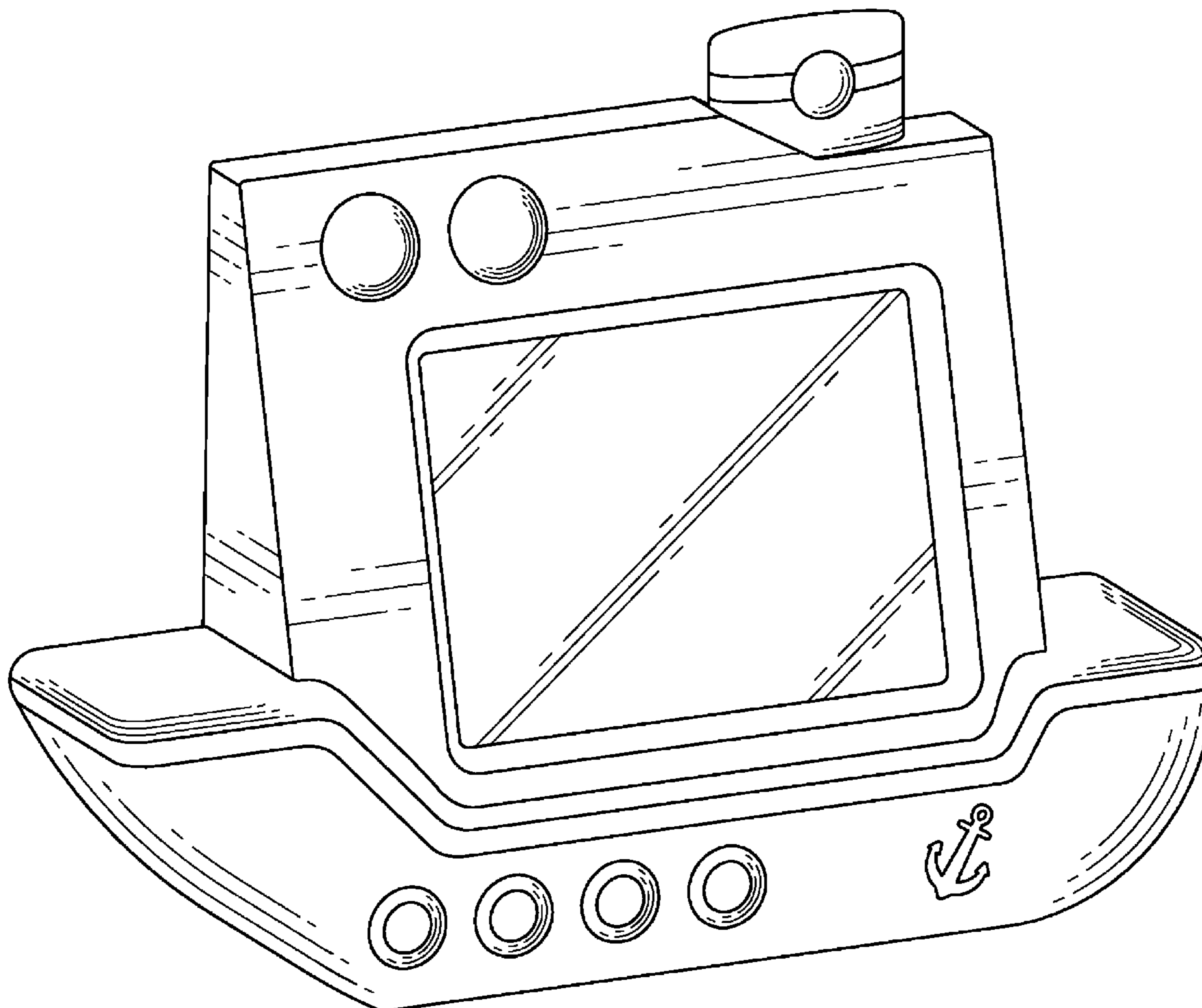

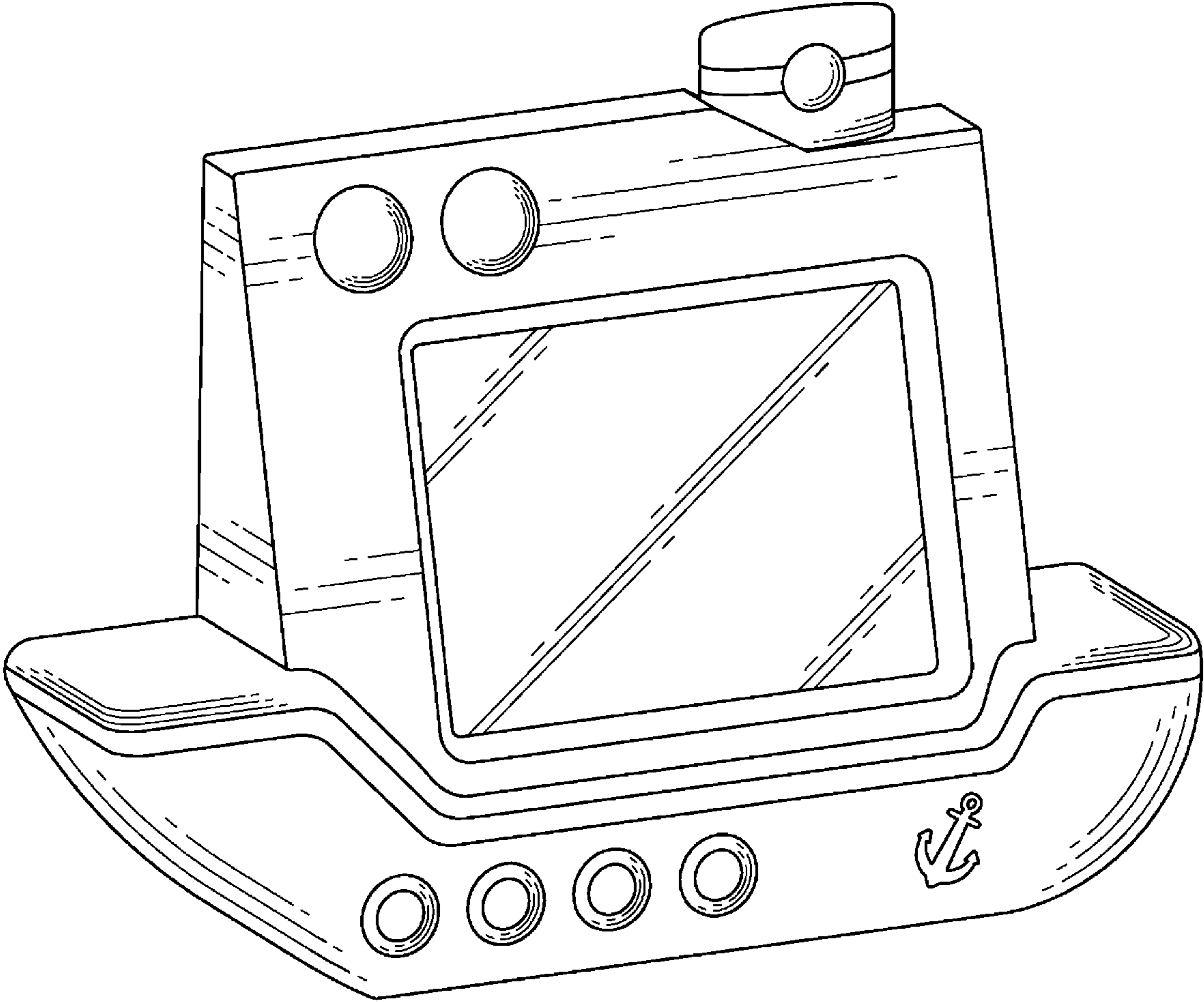

FIG. 1

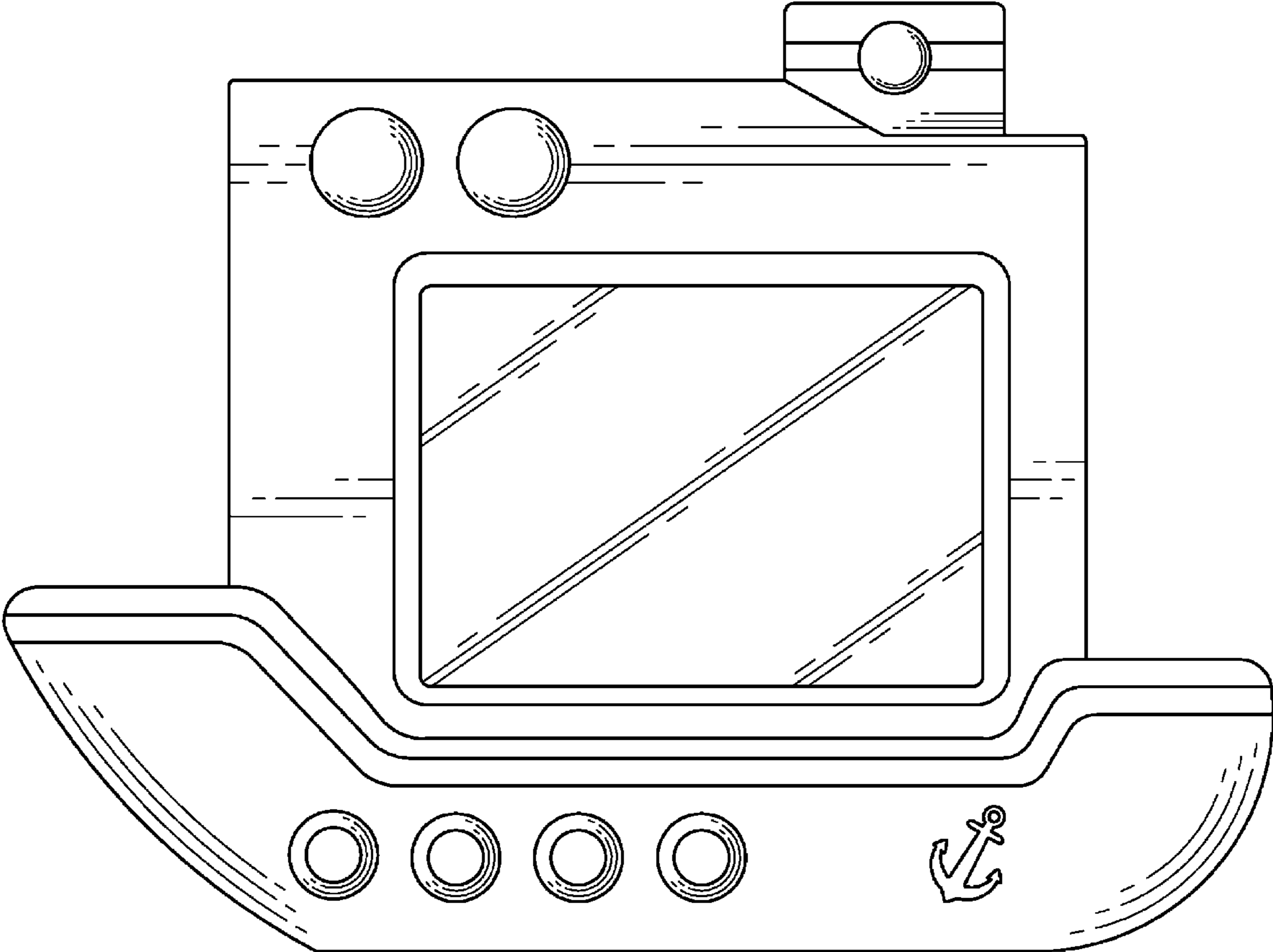

FIG. 2

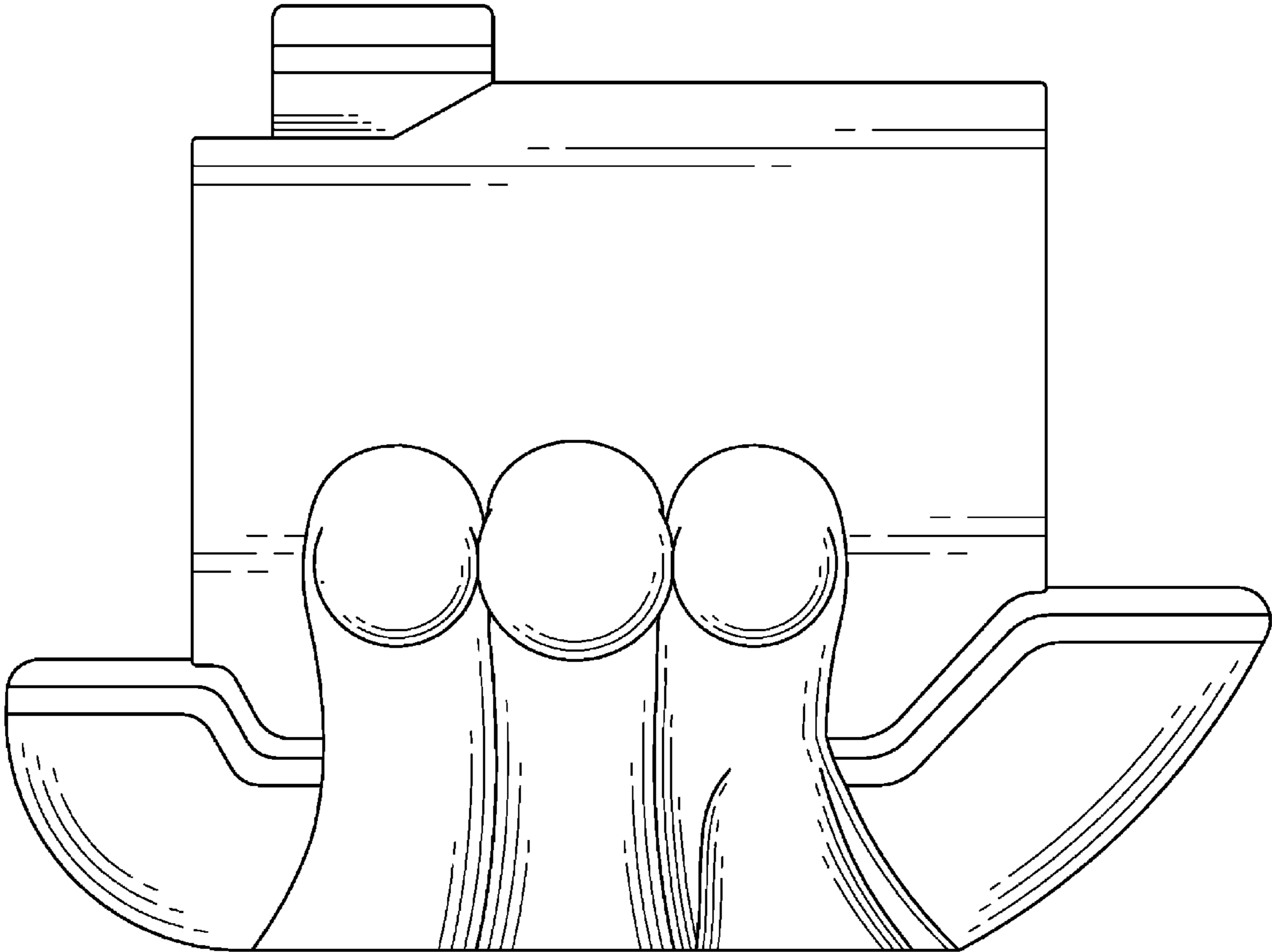

FIG. 3

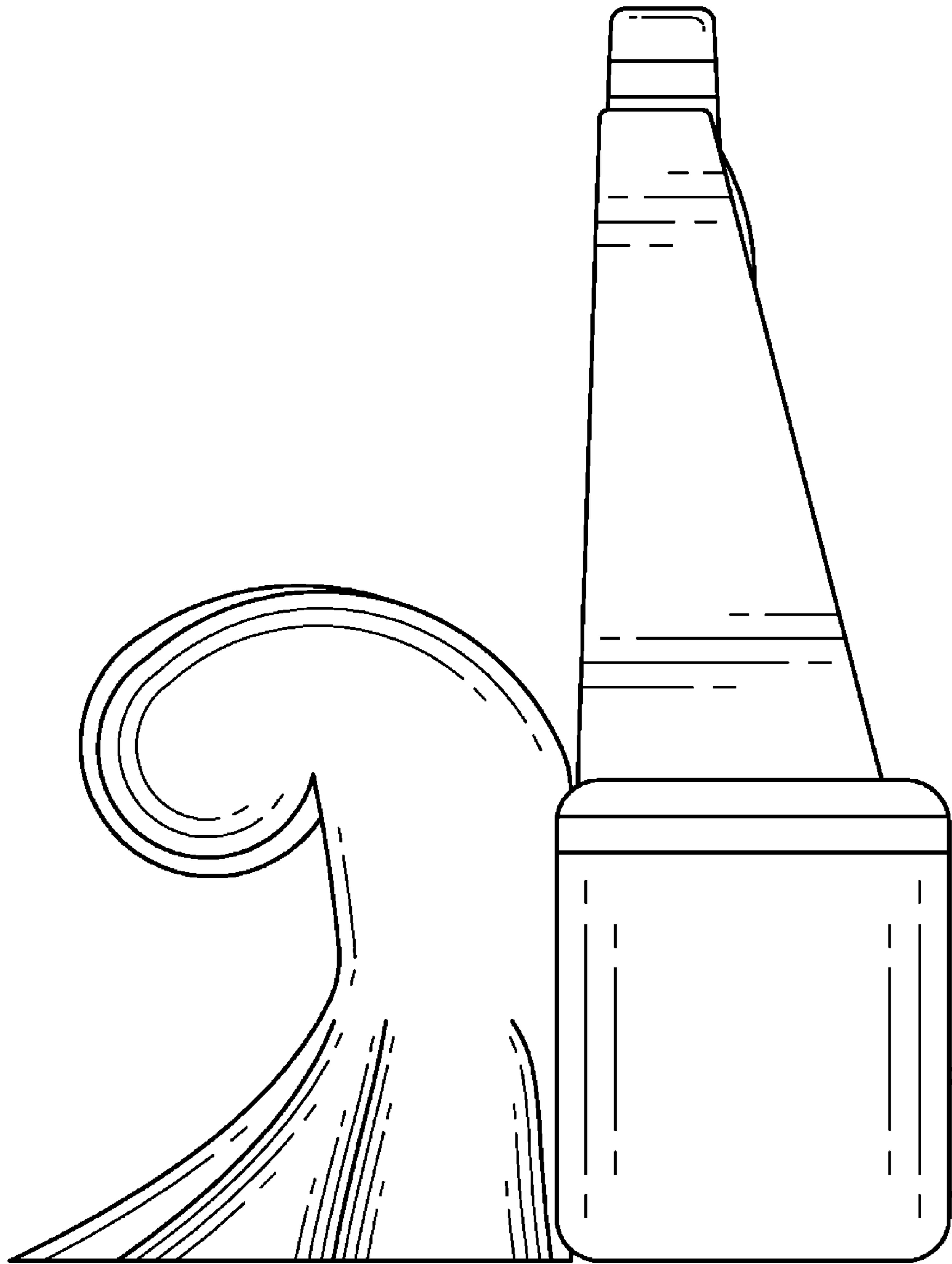

FIG. 4

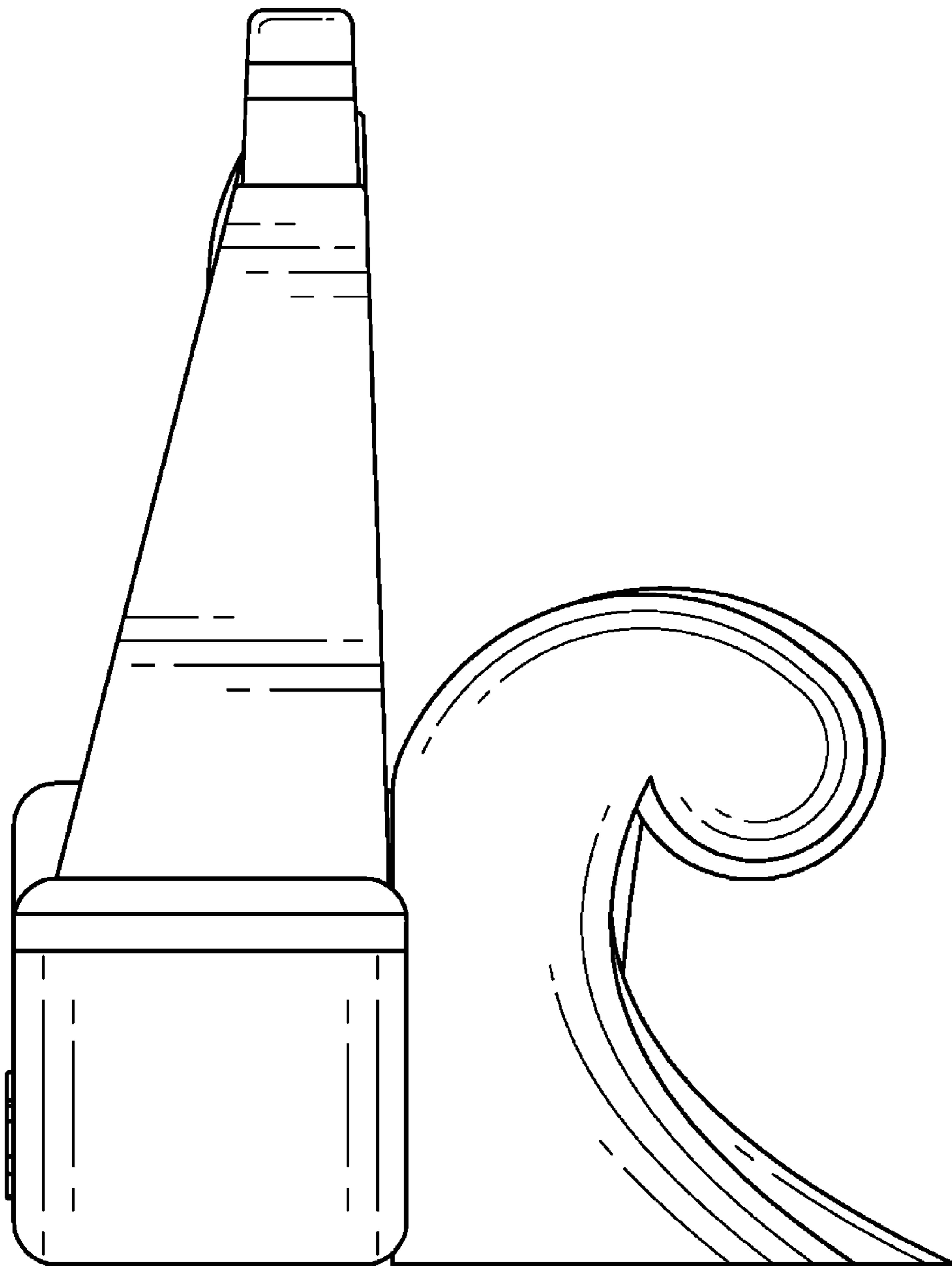

FIG. 5

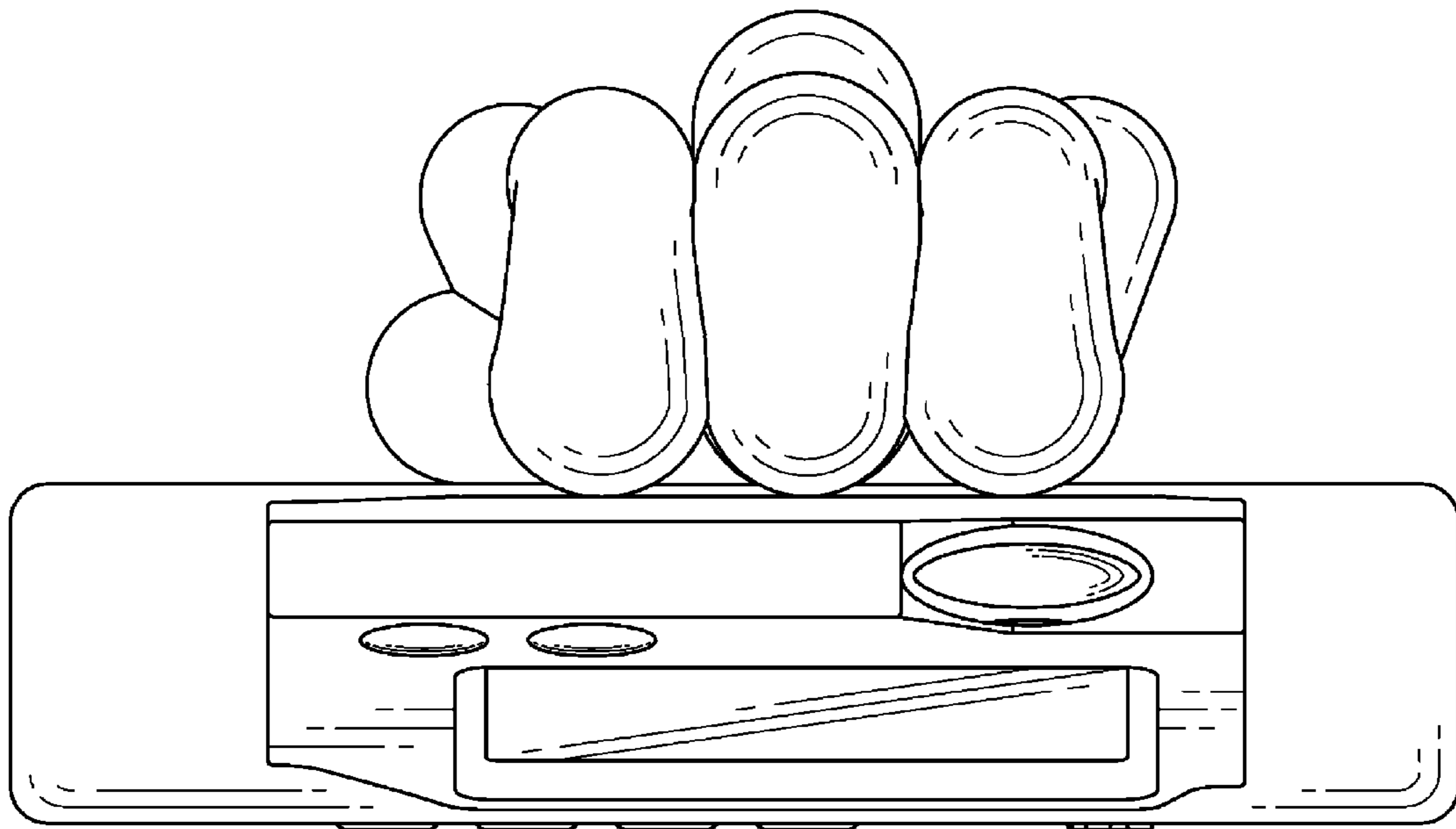

FIG.6

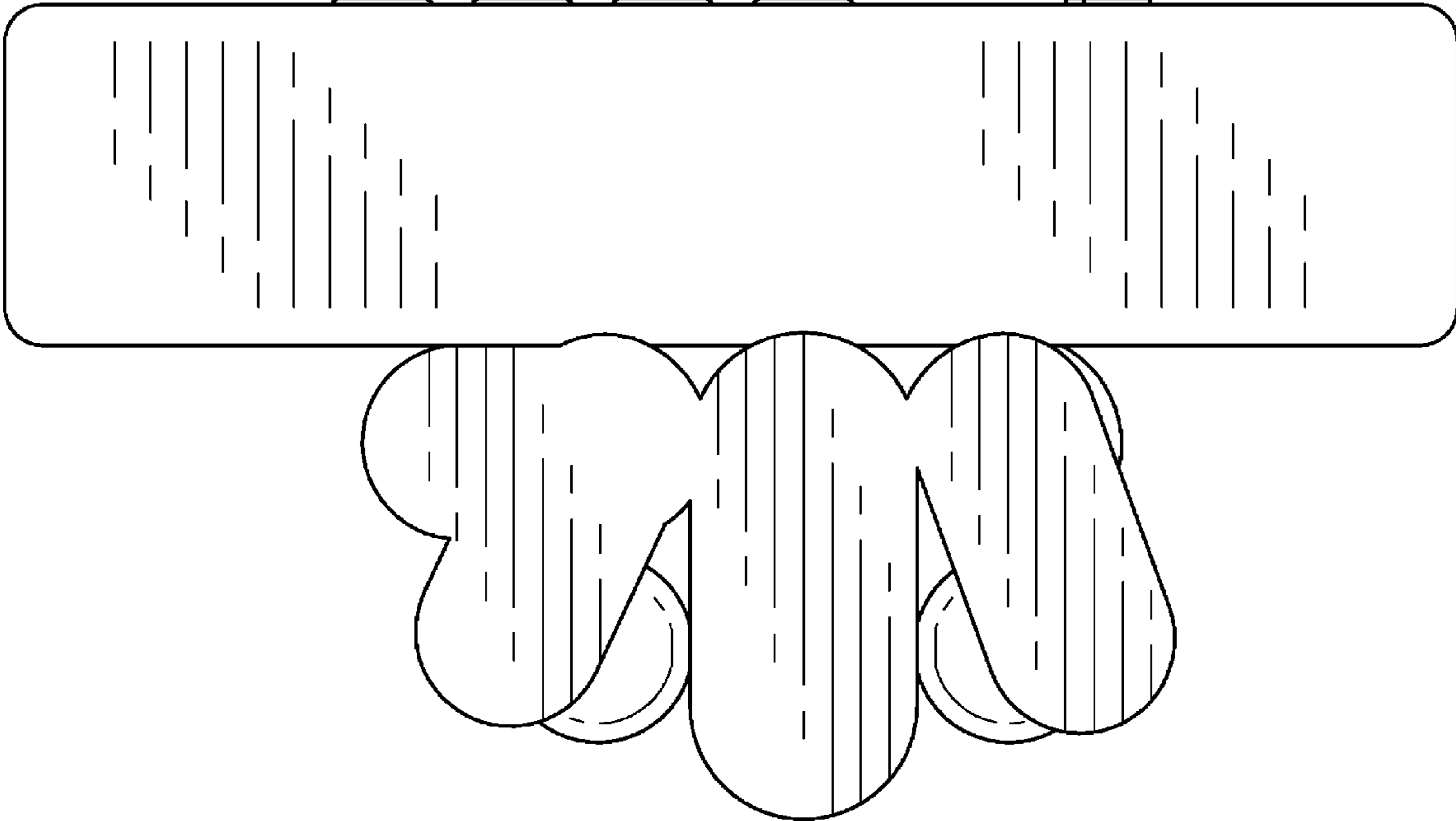

FIG. 7