



US00D634315S

(12) **United States Design Patent**  
**Nousiainen**

(10) **Patent No.:** **US D634,315 S**  
(45) **Date of Patent:** **\*\* Mar. 15, 2011**

(54) **HOLDER FOR A HANDSET**

(75) Inventor: **Esa Petteri Nousiainen**, Vantaa (FI)

(73) Assignee: **Nokia Corporation**, Espoo (FI)

(\*\*) Term: **14 Years**

(21) Appl. No.: **29/369,131**

(22) Filed: **Sep. 2, 2010**

(51) **LOC (9) Cl.** ..... **14-03**

(52) **U.S. Cl.** ..... **D14/253**

(58) **Field of Classification Search** ..... D14/140,  
D14/142, 149, 217, 240, 251-253, 434, 447,  
D14/452, 454; D8/363, 373; D12/415;  
248/206.2-206.4, 220.21, 279.1; 379/426,  
379/446, 454, 455; D13/107-108; D16/242;  
D3/218

See application file for complete search history.

(56) **References Cited**

**U.S. PATENT DOCUMENTS**

D248,950	S	*	8/1978	Vitacco	.....	D14/240
D301,883	S	*	6/1989	Kroplopp et al.	.....	D14/142
5,016,851	A	*	5/1991	Koskinen et al.	.....	248/278.1
5,033,709	A	*	7/1991	Yuen	.....	248/313
D329,749	S	*	9/1992	Scheid	.....	D3/218
5,187,744	A	*	2/1993	Richter	.....	379/449
D346,275	S	*	4/1994	Hayasaka et al.	.....	D3/218
D348,355	S	*	7/1994	Scheid et al.	.....	D3/218
D350,545	S	*	9/1994	Olkola et al.	.....	D14/253
D356,798	S	*	3/1995	Rudkiewicz et al.	.....	D14/253
D360,210	S	*	7/1995	Rudkiewicz et al.	.....	D14/253
D361,335	S	*	8/1995	Rudkiewicz et al.	.....	D14/253
D372,189	S	*	7/1996	Andis et al.	.....	D8/373
5,697,071	A	*	12/1997	Fan	.....	455/575.9
D392,646	S	*	3/1998	Takayasu et al.	.....	D14/253
D456,395	S	*	4/2002	Lehtovaara	.....	D14/253
D471,547	S	*	3/2003	Ruohonen	.....	D14/253
D508,605	S	*	8/2005	Hwang et al.	.....	D3/218
D528,539	S	*	9/2006	McClaude	.....	D14/253

(Continued)

**FOREIGN PATENT DOCUMENTS**

WO DM/069888 5/2008

**OTHER PUBLICATIONS**

Universal Cellphone Mount/Holder, <URL:http://www.accessorygeeks.com/starter-package-2-micro-usb.html>, retrieved from Internet Jan. 13, 2010.\*

*Primary Examiner* — Robert M Spear

*Assistant Examiner* — Carla Jobe Wright

(74) *Attorney, Agent, or Firm* — Banner & Witcoff, Ltd.

(57) **CLAIM**

The ornamental design for a holder for a handset, as shown and described.

**DESCRIPTION**

FIG. 1 is a perspective view of a holder for a handset showing my new design;

FIG. 2 is a front view thereof;

FIG. 3 is a rear view thereof;

FIG. 4 is a left side view thereof;

FIG. 5 is a right side view thereof;

FIG. 6 is a top view thereof;

FIG. 7 is a bottom view thereof;

FIG. 8 is a perspective view of a second embodiment of a holder for a handset showing my new design;

FIG. 9 is a front view thereof;

FIG. 10 is a rear view thereof;

FIG. 11 is a left side view thereof;

FIG. 12 is a right side view thereof;

FIG. 13 is a top view thereof; and,

FIG. 14 is a bottom view thereof.

The broken lines shown in FIGS. 1-7 that are immediately adjacent to the shaded areas represent boundaries of the claim of the first embodiment. The broken lines and unshaded surfaces bounded by broken lines form no part of the claim of the first embodiment.

**1 Claim, 8 Drawing Sheets**

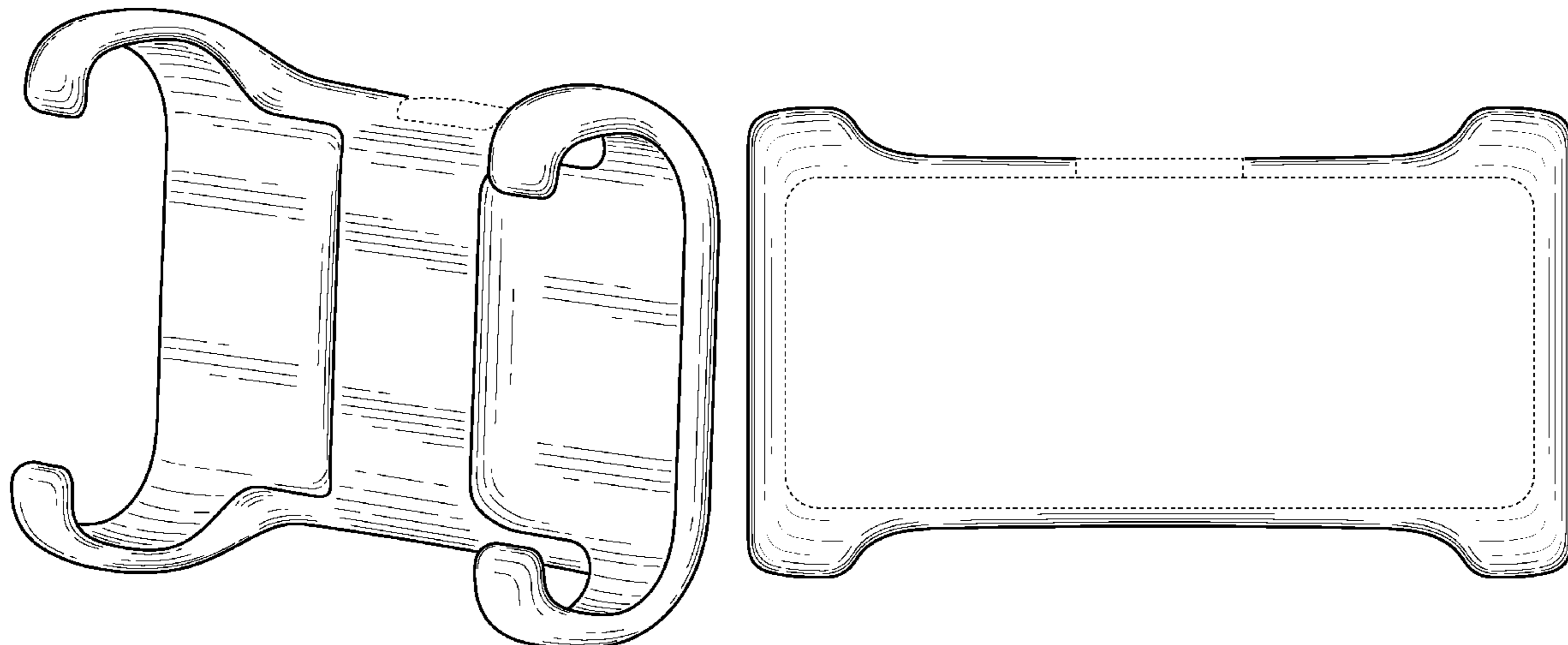

# US D634,315 S

Page 2

---

## U.S. PATENT DOCUMENTS

D529,489 S	*	10/2006	Sbordon, Jr. ....	D14/253	D596,172 S	*	7/2009	Ahlqvist .....	D14/251
D529,905 S	*	10/2006	Richter .....	D14/253	D605,645 S		12/2009	Kettula	
D530,713 S	*	10/2006	Richter .....	D14/253	D606,065 S		12/2009	Rihu	
D535,988 S	*	1/2007	Kettula et al. ....	D14/253	D626,953 S	*	11/2010	Wilson .....	D14/252
D577,358 S		9/2008	Kettula et al.		D627,771 S	*	11/2010	Smith et al. ....	D14/253

\* cited by examiner

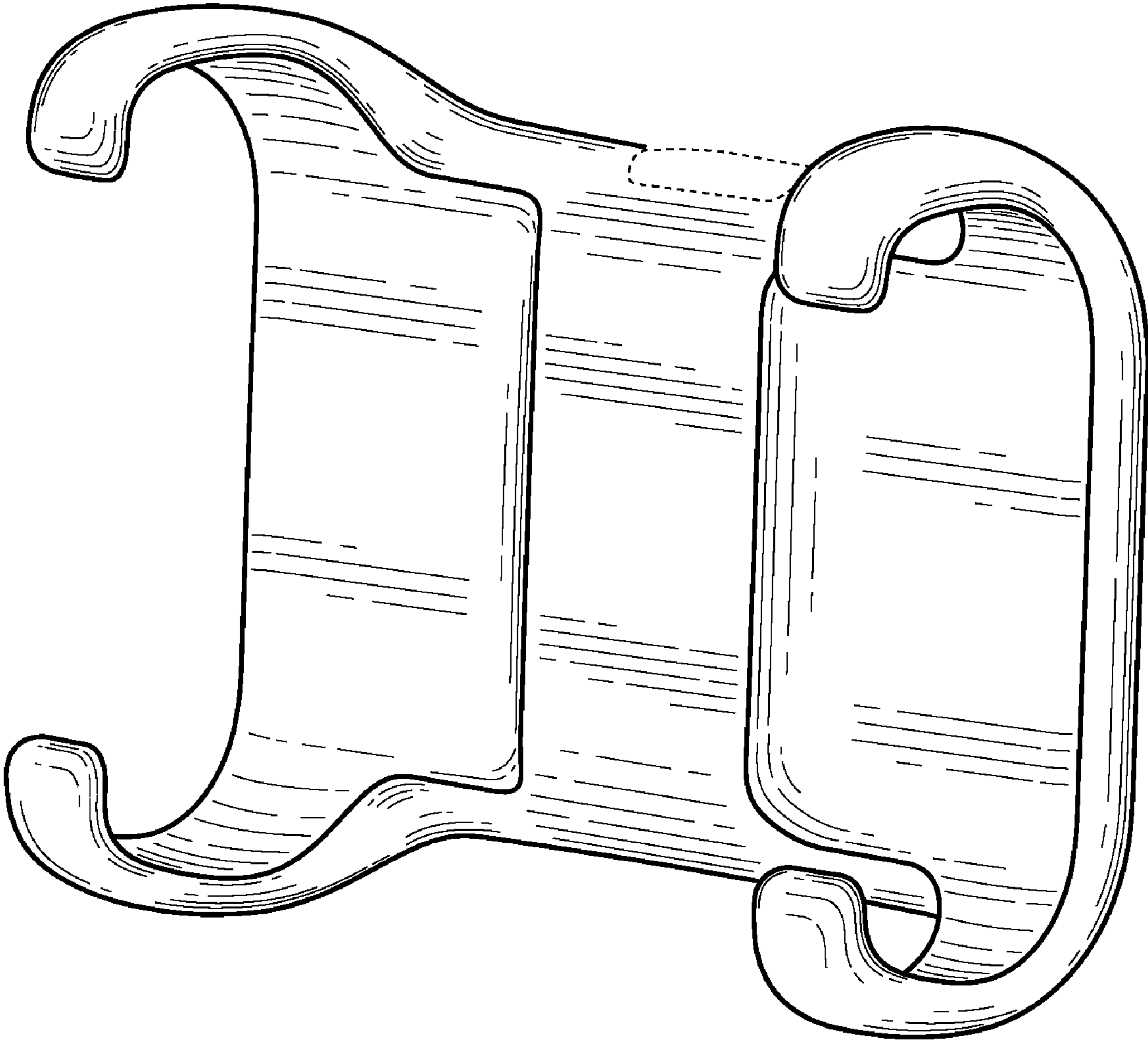

FIG. 1

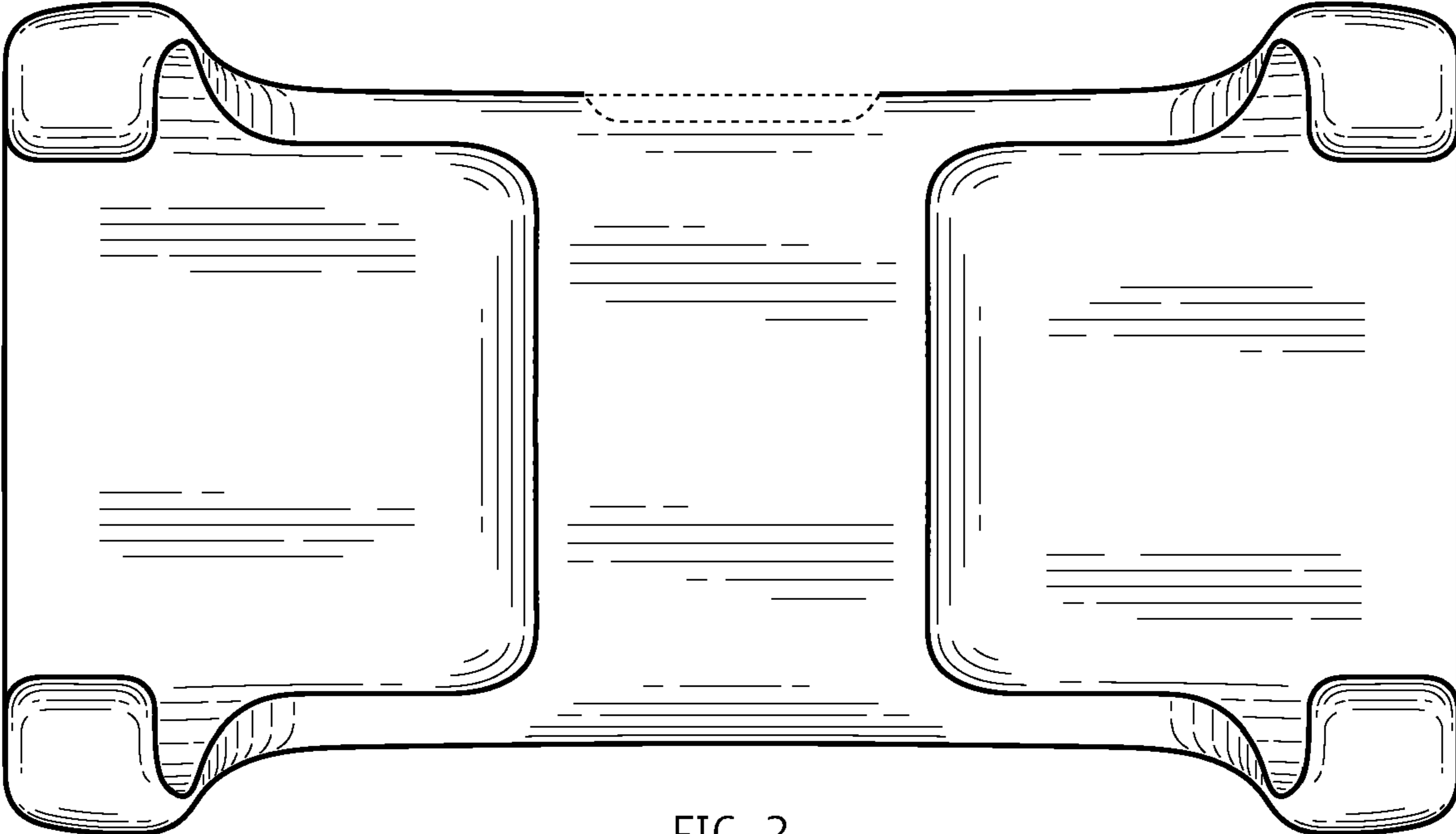

FIG. 2

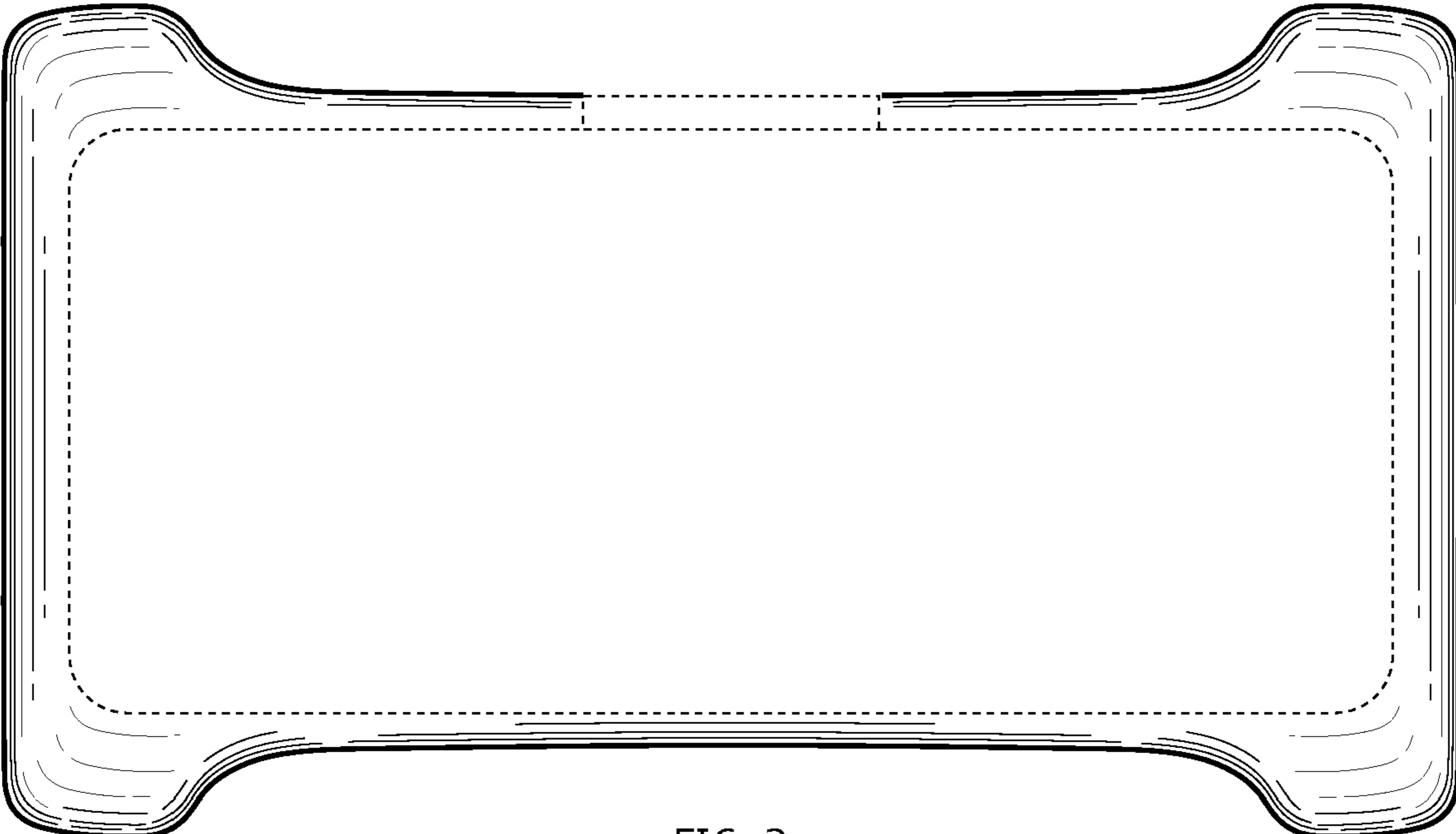

FIG. 3

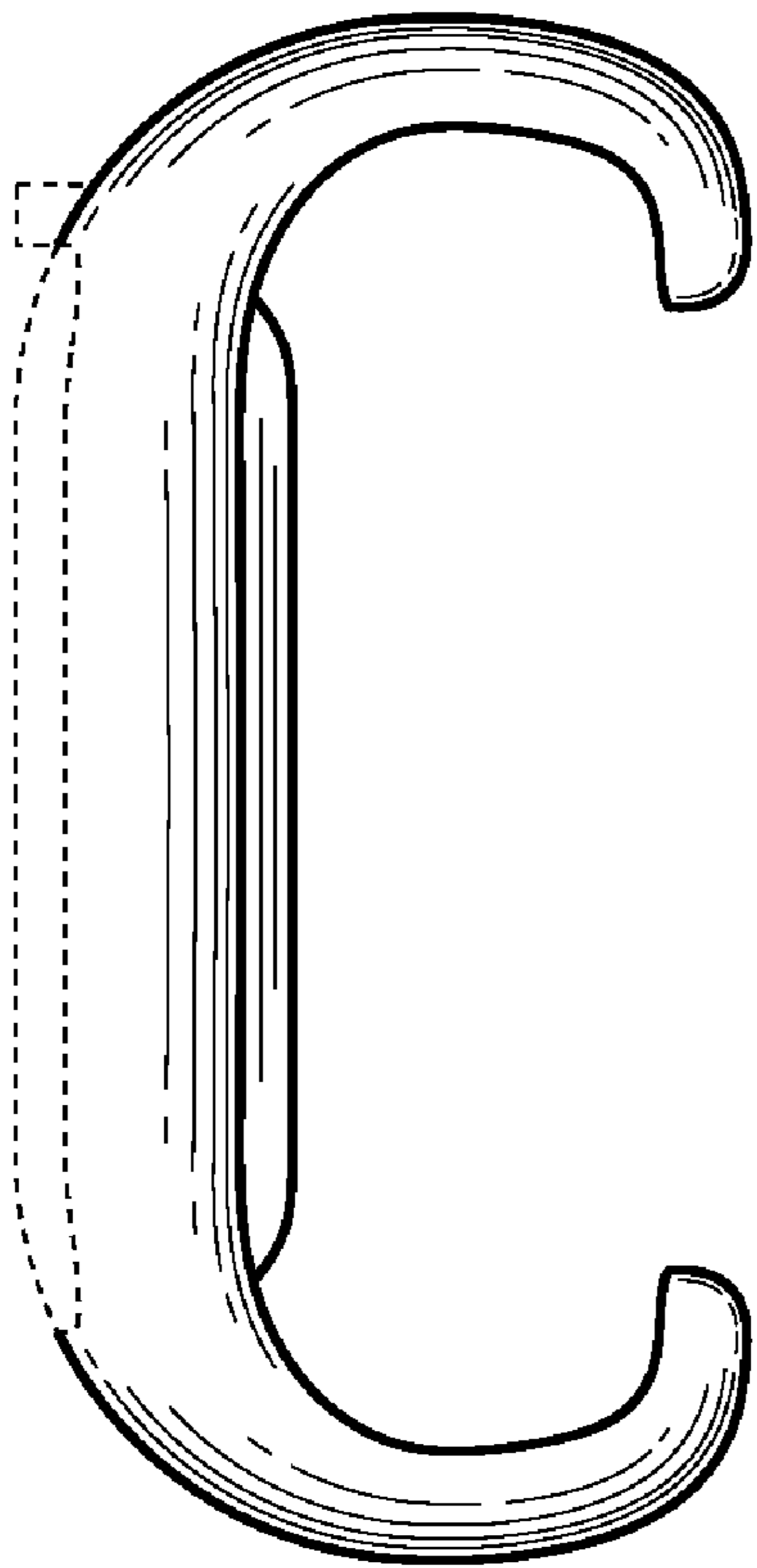

FIG. 4

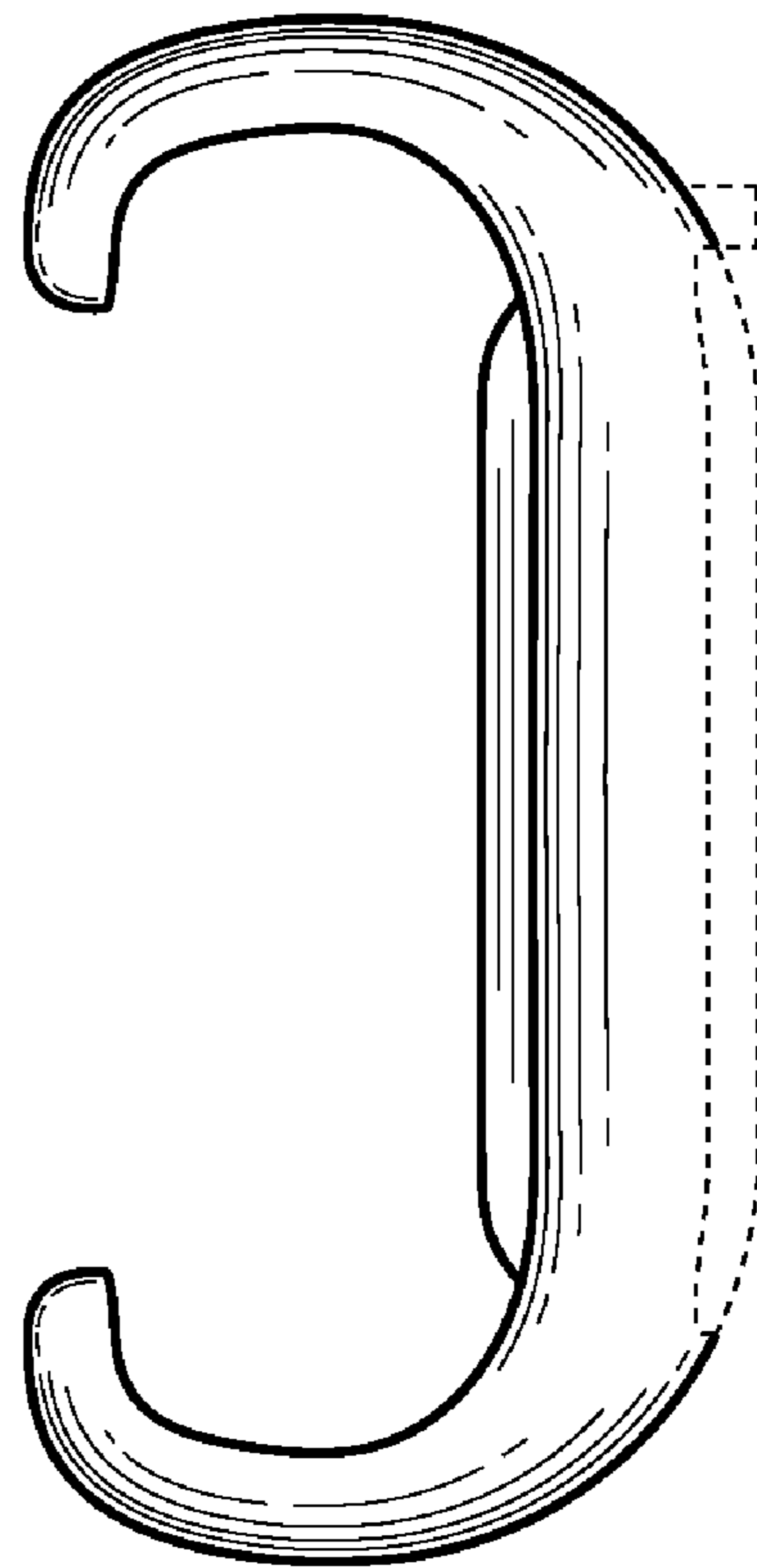

FIG. 5

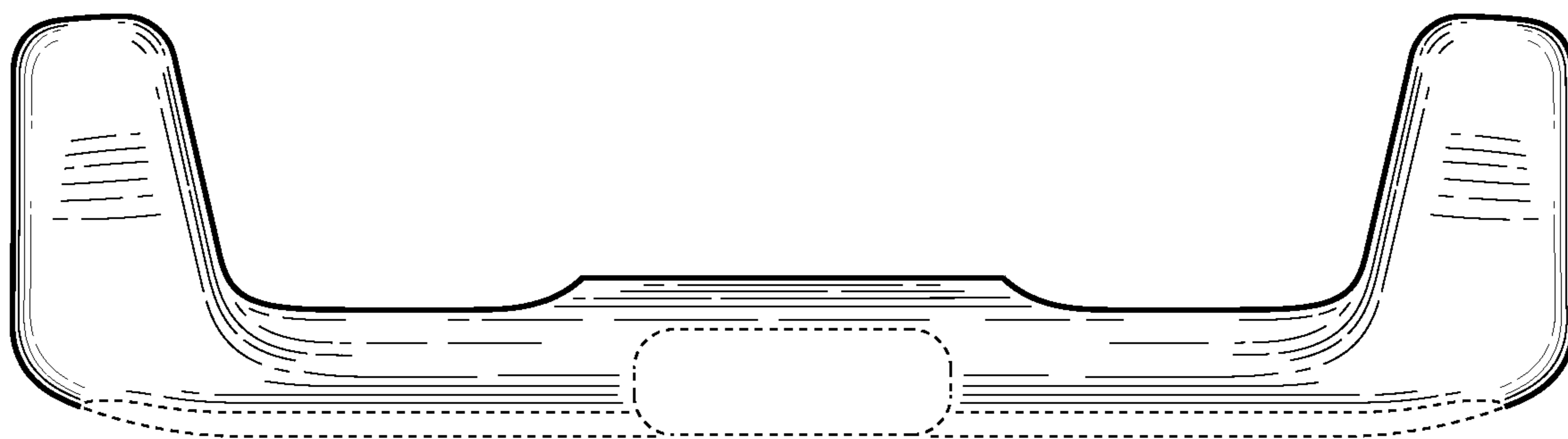

FIG. 6

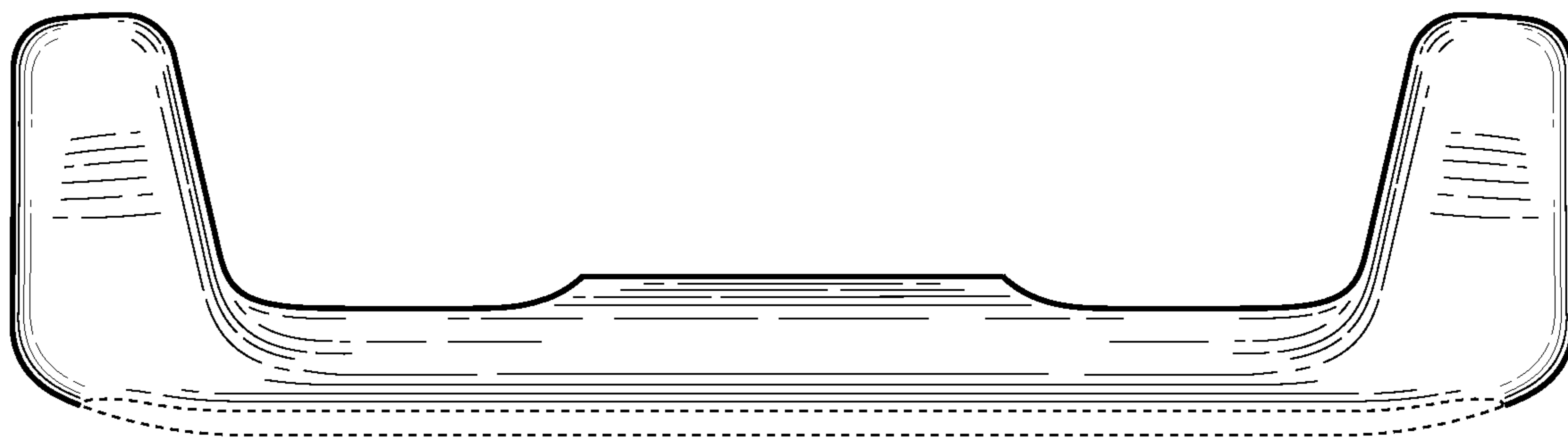

FIG. 7

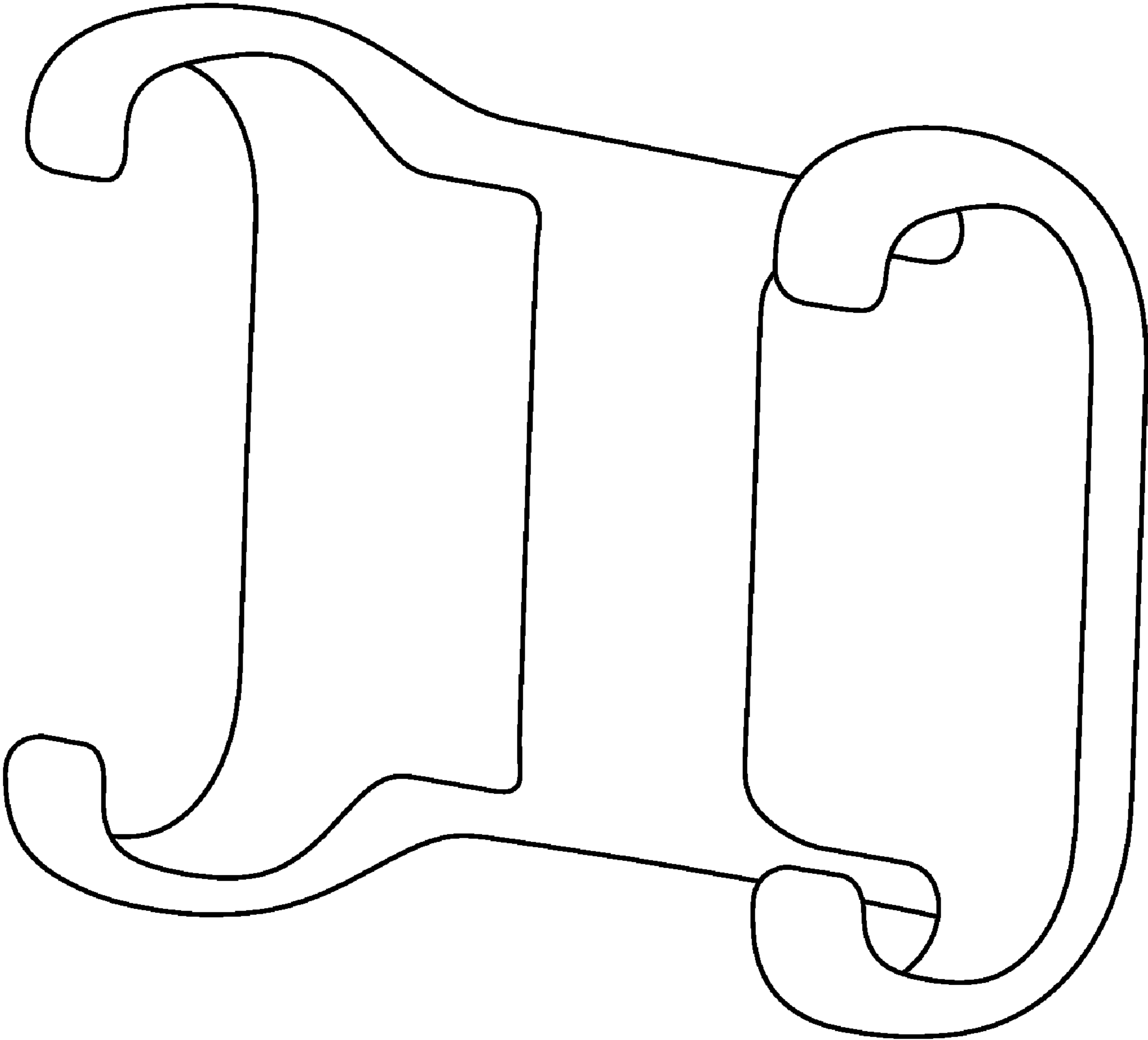

FIG. 8

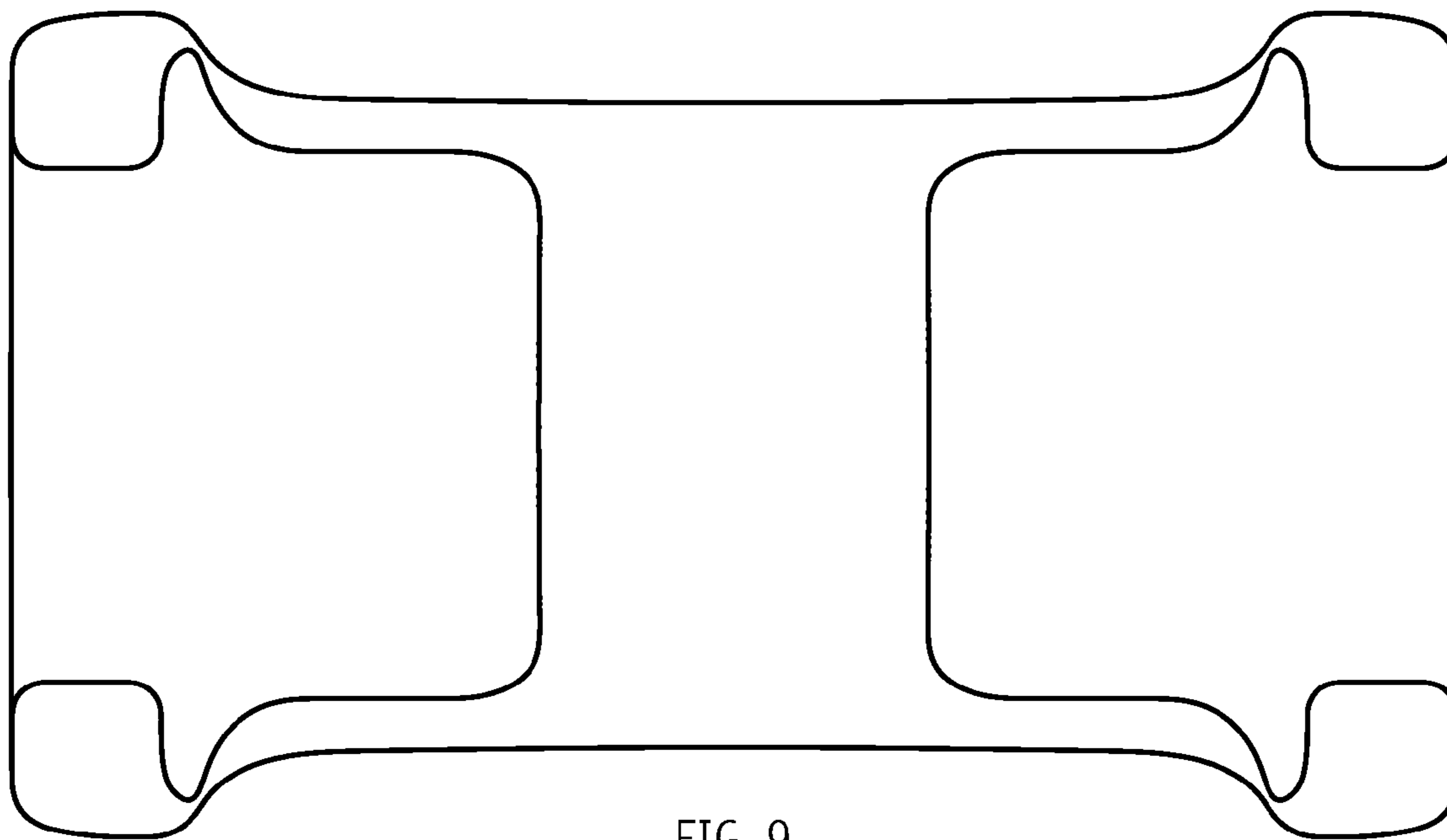

FIG. 9

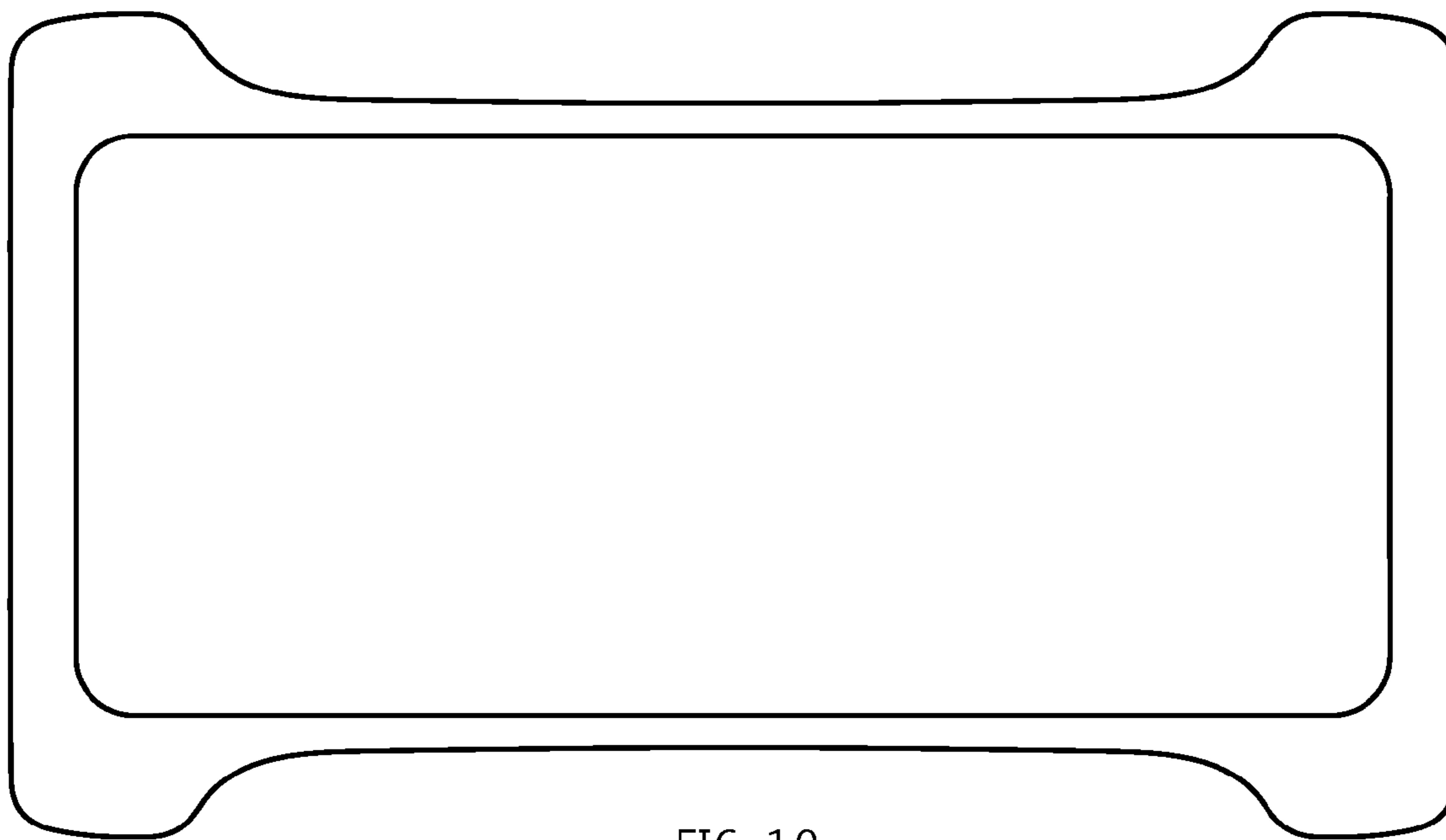

FIG. 10



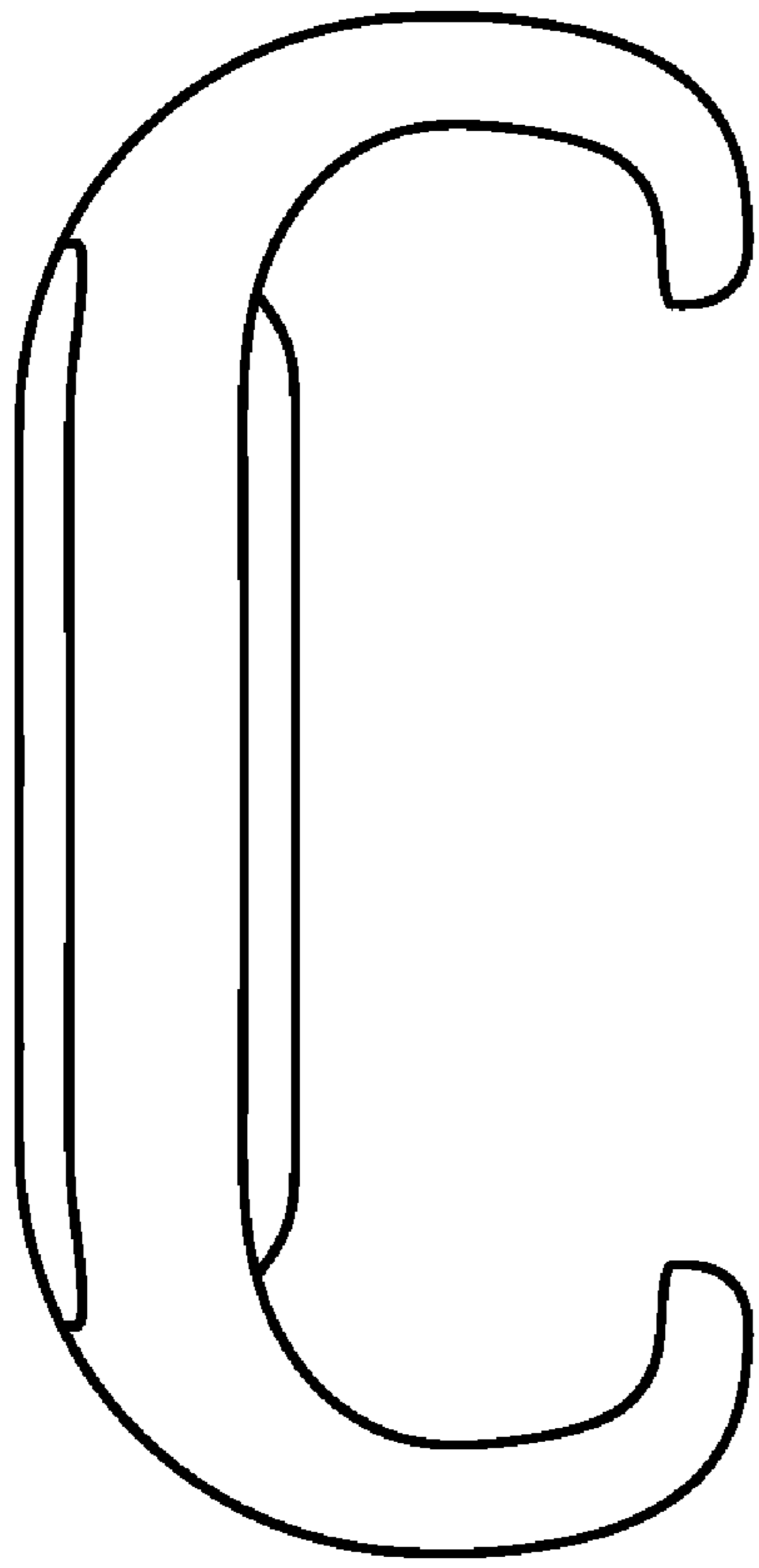

FIG. 11

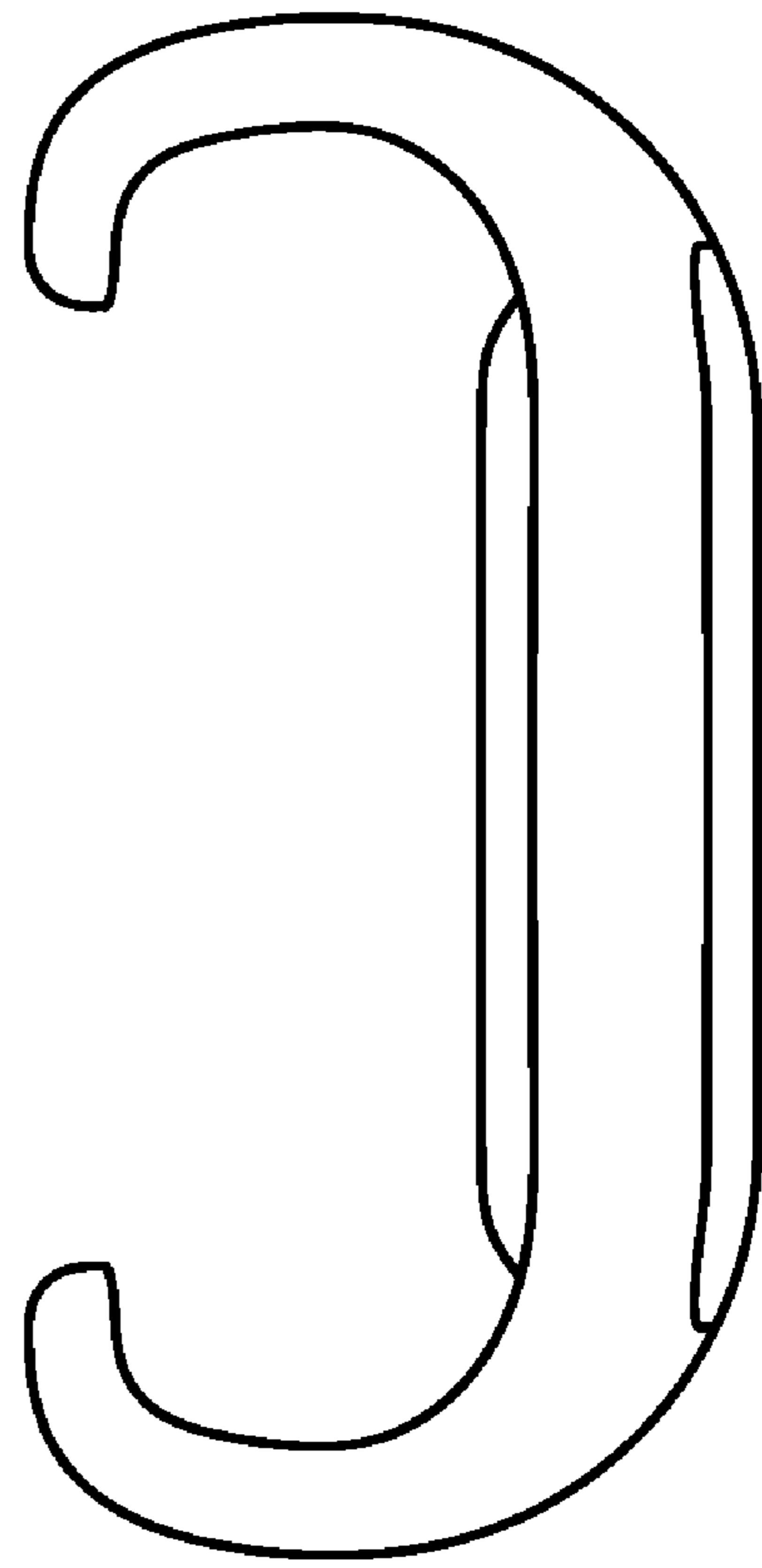

FIG. 12

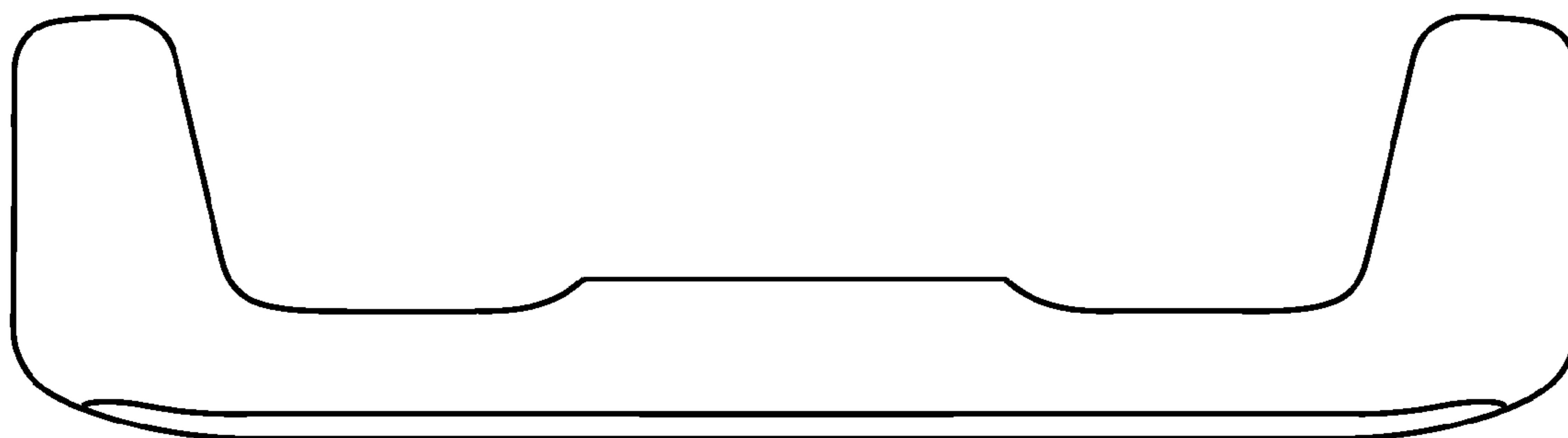

FIG. 13

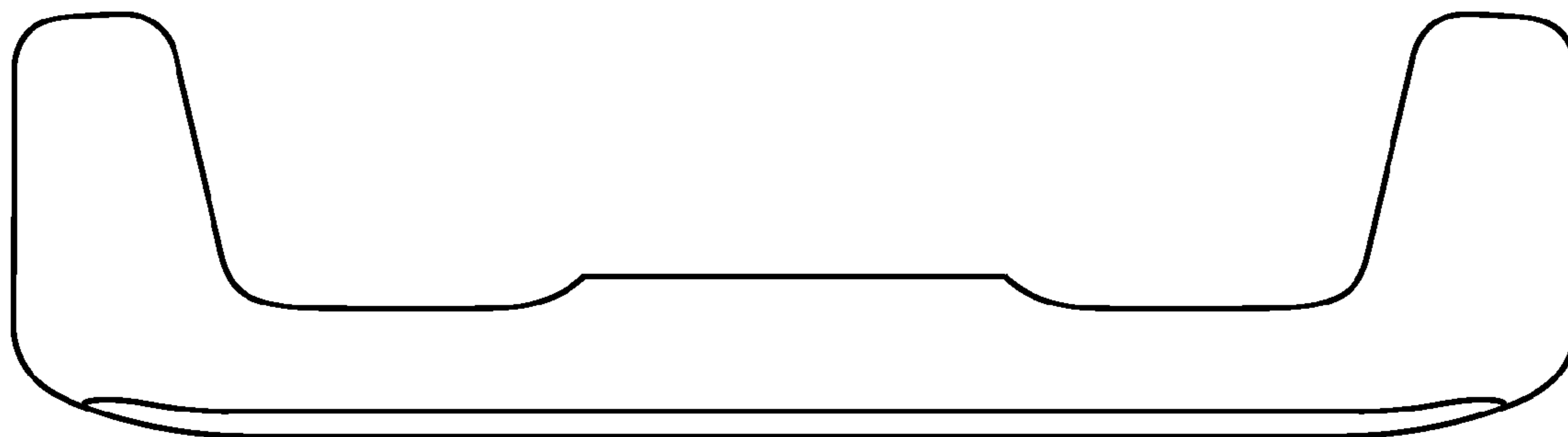

FIG. 14