



US00D634174S

(12) **United States Design Patent**
Ryan et al.

(10) **Patent No.:** **US D634,174 S**
(45) **Date of Patent:** **** Mar. 15, 2011**

(54) **FOLDING KNIFE**

(75) Inventors: **Steven T. Ryan**, Westminster, CA (US);
Douglas J. Port, Huntington Beach, CA
(US)

(73) Assignee: **SureFire, LLC**, Fountain Valley, CA
(US)

(**) Term: **14 Years**

(21) Appl. No.: **29/341,193**

(22) Filed: **Jul. 31, 2009**

(51) **LOC (9) Cl.** **08-03**

(52) **U.S. Cl.** **D8/99**

(58) **Field of Classification Search** D7/649;
D8/95-99, 107; D22/118; 30/154-162,
30/329-331

See application file for complete search history.

(56) **References Cited**

U.S. PATENT DOCUMENTS

D270,655 S *	9/1983	Collins	D22/118
D302,934 S *	8/1989	Finn	D8/99
D306,687 S *	3/1990	Inman	D8/99
D366,408 S *	1/1996	Sessions et al.	D8/99
D438,443 S *	3/2001	Keating	D8/99
D461,387 S *	8/2002	Glesser	D8/99
D479,104 S *	9/2003	Onion	D7/649
D505,057 S *	5/2005	Ralph	D8/99
D539,631 S *	4/2007	Taylor	D8/107
D553,469 S *	10/2007	Onion	D8/99
7,513,044 B2 *	4/2009	Lake	30/155
D607,530 S *	1/2010	Craffey	D22/118
D611,320 S *	3/2010	Jeandupeux	D8/99

D613,574 S *	4/2010	Pohl	D8/99
D623,038 S *	9/2010	Seeds et al.	D8/107
2005/0097755 A1 *	5/2005	Galyean et al.	30/161

OTHER PUBLICATIONS

SureFire Edge Folding Combat Utility Knife—EW-09. Downloaded Oct. 11, 2010 at <http://www.surefire.com/EW-09>.
Kershaw BOA Linerlocks. Smoky Mountain Knife Works, Christmas 2000 catalog.*

* cited by examiner

Primary Examiner — Philip S Hyder

Assistant Examiner — Roselynn Cody

(74) *Attorney, Agent, or Firm* — Haynes and Boone, LLP

(57) **CLAIM**

The ornamental design for a folding knife, as shown and described.

DESCRIPTION

FIG. 1 is a front perspective view of a folding knife showing our new design, illustrated in an open position;
FIG. 2 is a rear perspective view thereof;
FIG. 3 is a top plan view thereof;
FIG. 4 is a bottom plan view thereof;
FIG. 5 is a left side elevational view thereof;
FIG. 6 is a right side elevational view thereof;
FIG. 7 is a front side elevational view thereof; and
FIG. 8 is a rear side elevational view thereof.
FIG. 9 is a front perspective view of the folding knife, illustrated in a closed position;
FIG. 10 is a rear perspective view thereof;
FIG. 11 is a top plan view thereof;
FIG. 12 is a bottom plan view thereof;
FIG. 13 is a left side elevational view thereof;
FIG. 14 is a right side elevational view thereof;
FIG. 15 is a front side elevational view thereof; and
FIG. 16 is a rear side elevational view thereof.

1 Claim, 12 Drawing Sheets

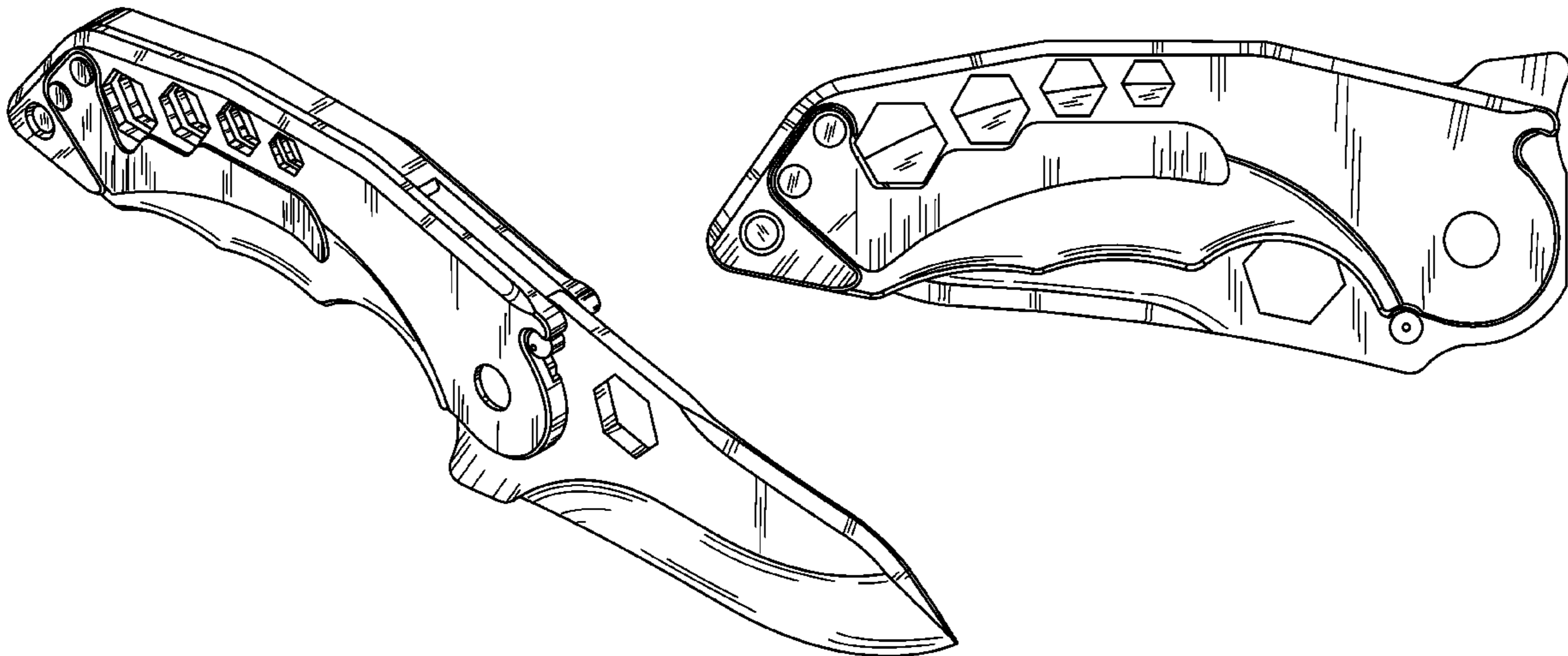

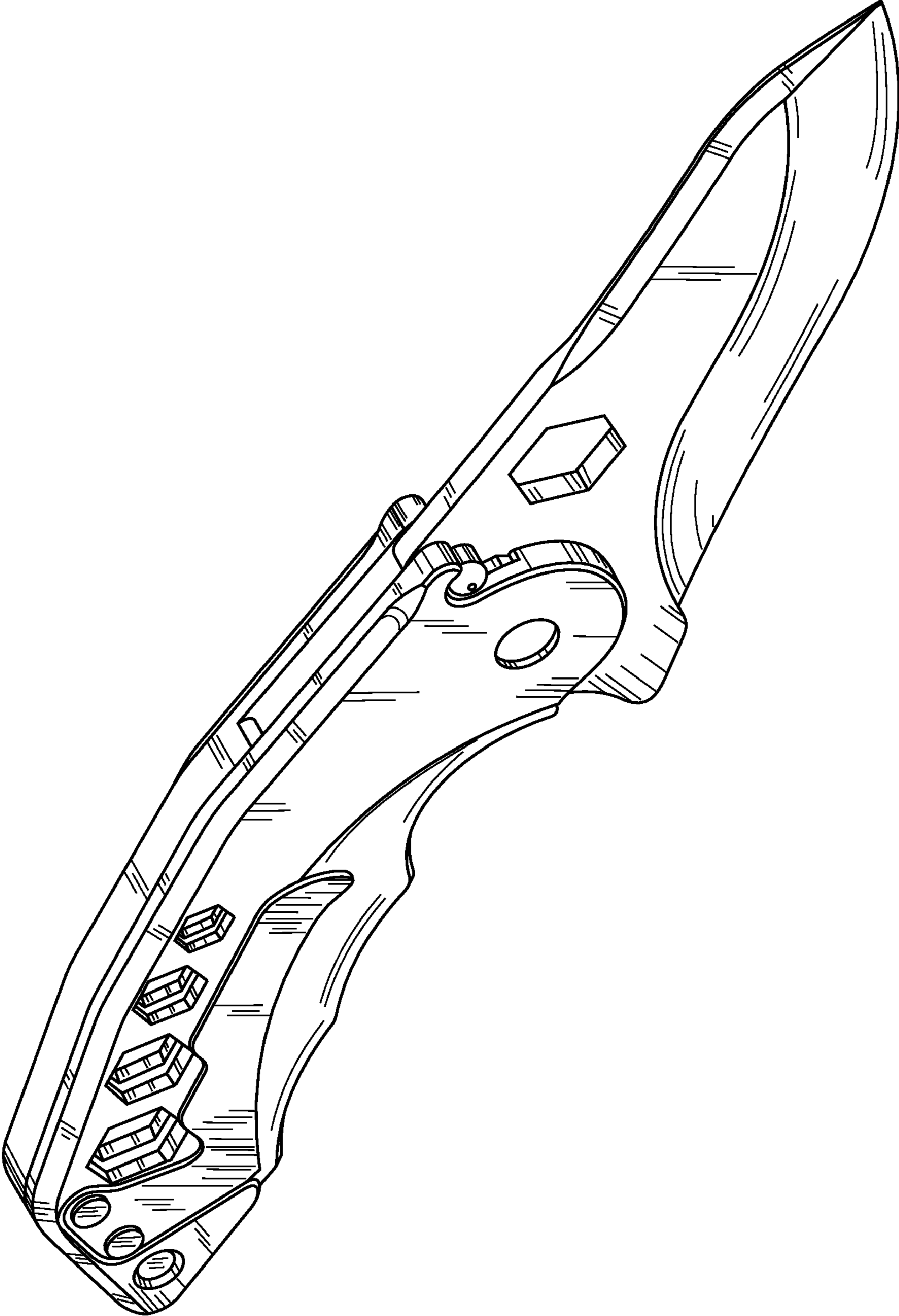

FIG. 1

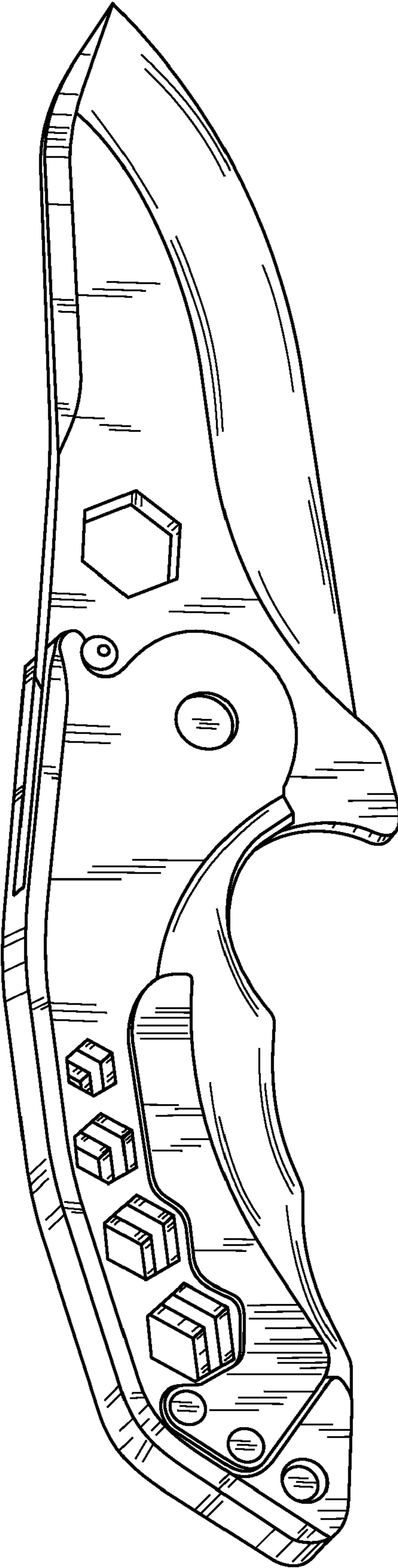

FIG. 2

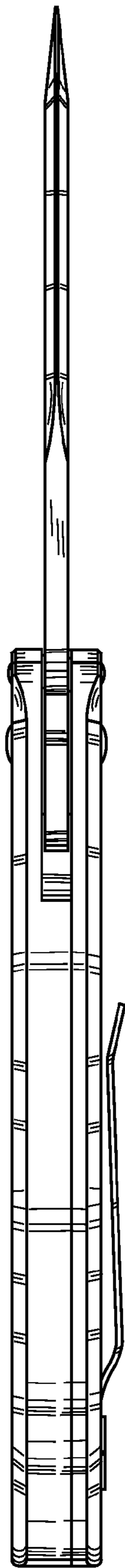

FIG. 3

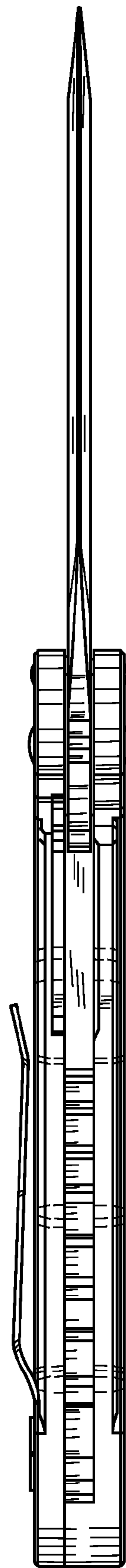

FIG. 4

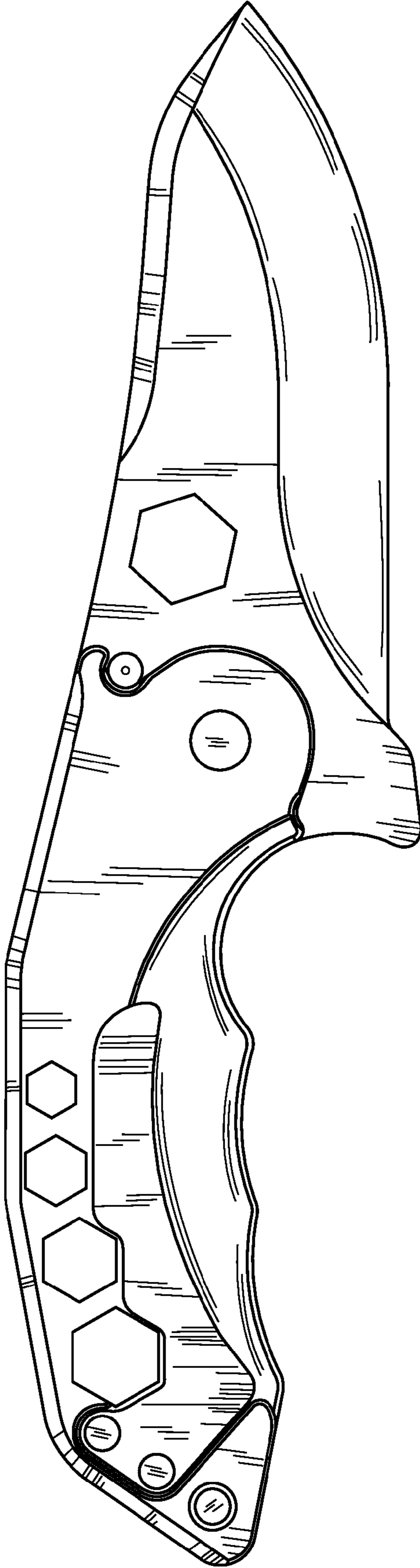

FIG. 5

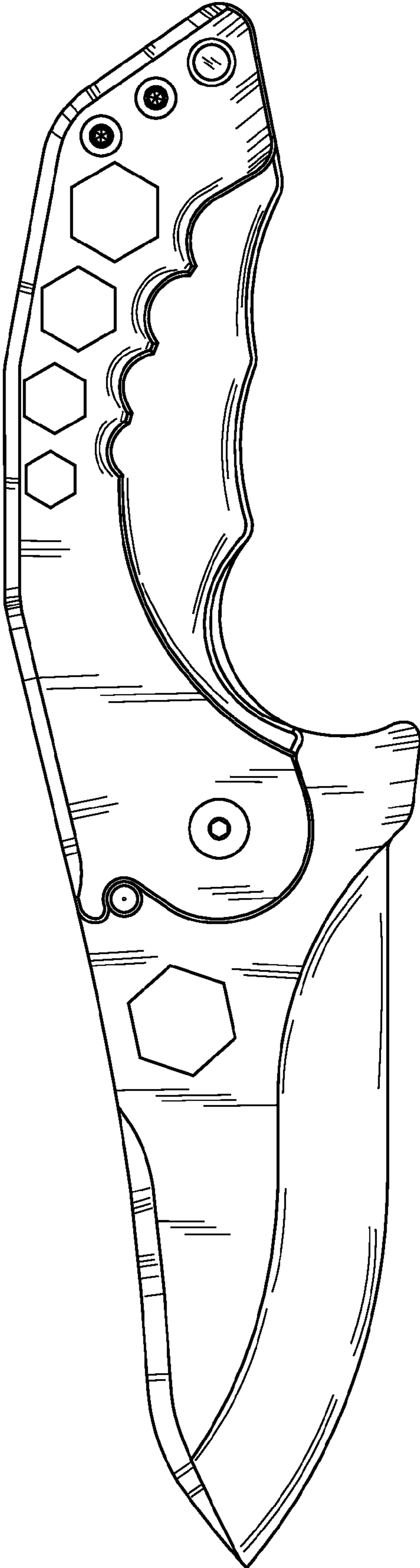

FIG. 6

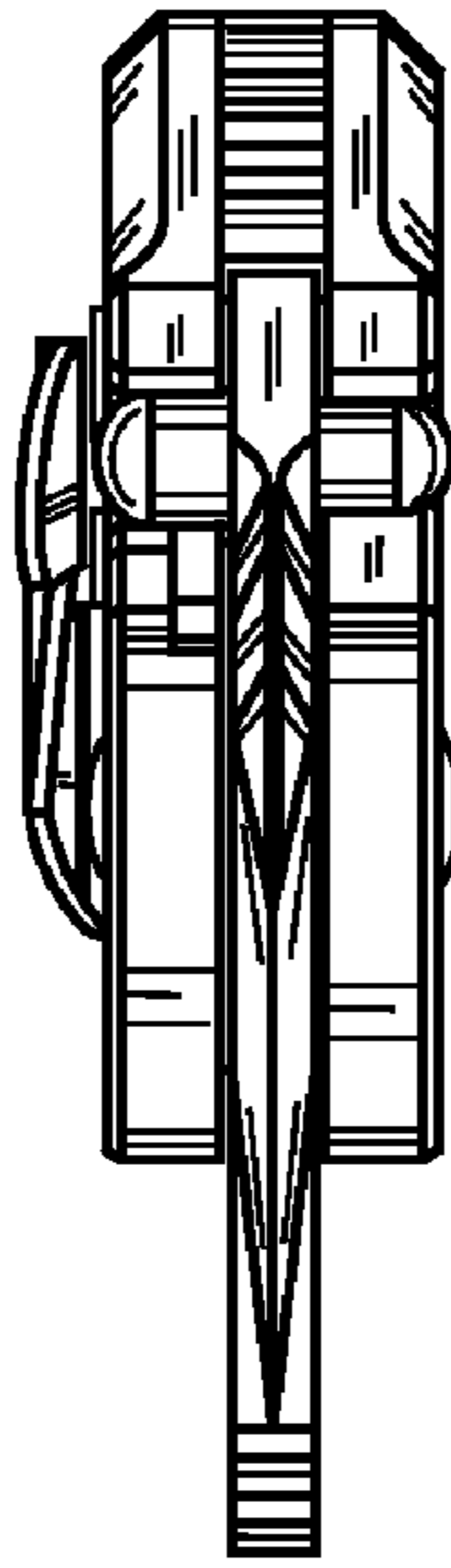

FIG. 7

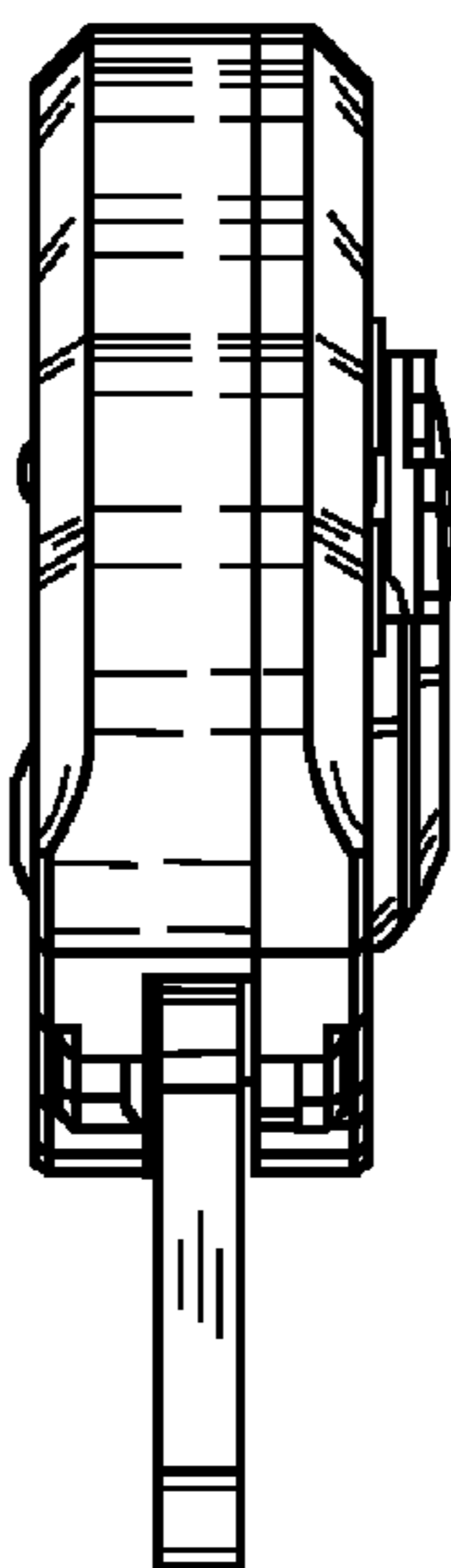

FIG. 8

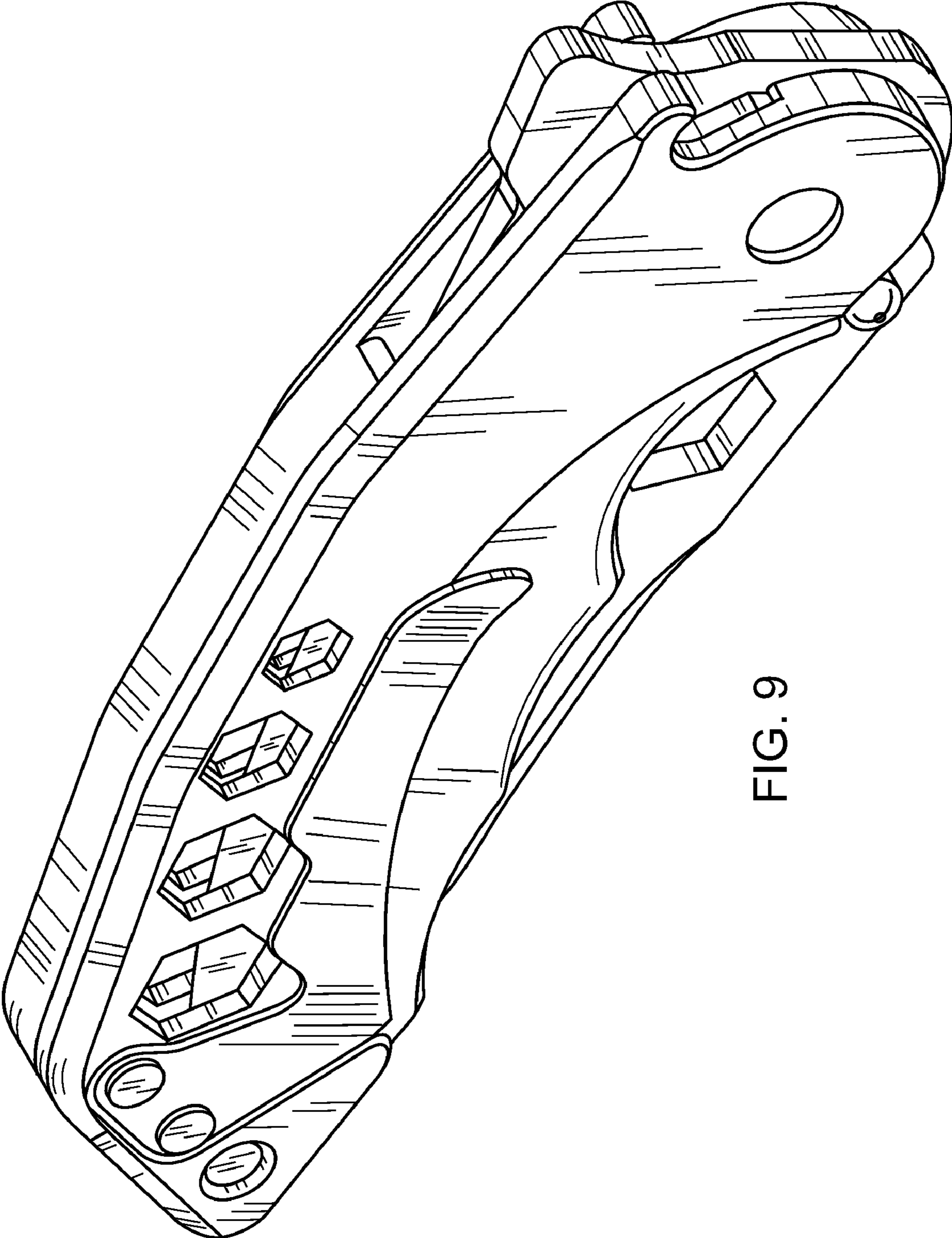

FIG. 9

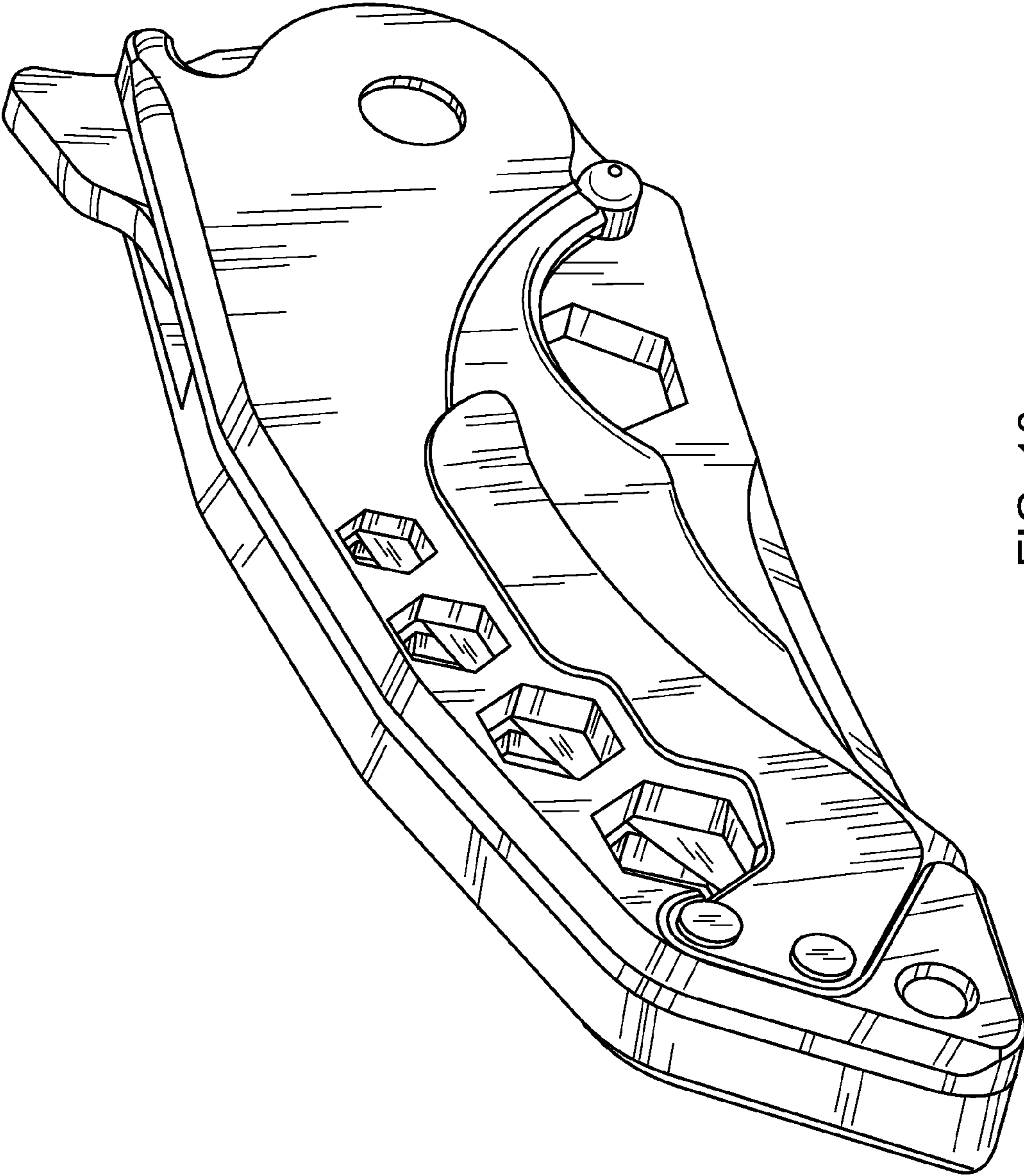

FIG. 10

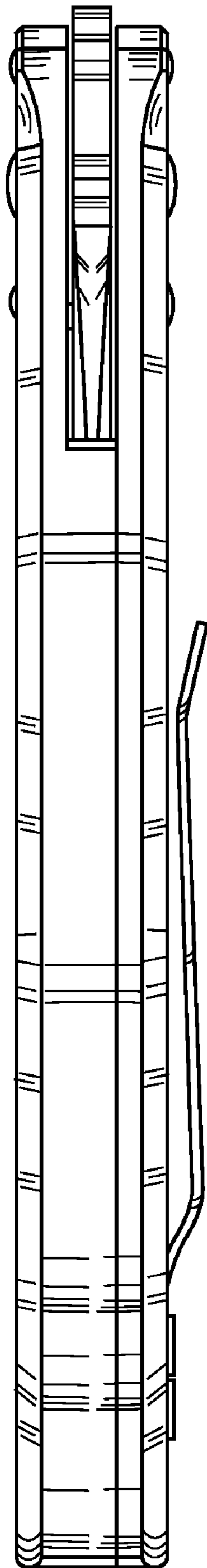

FIG. 11

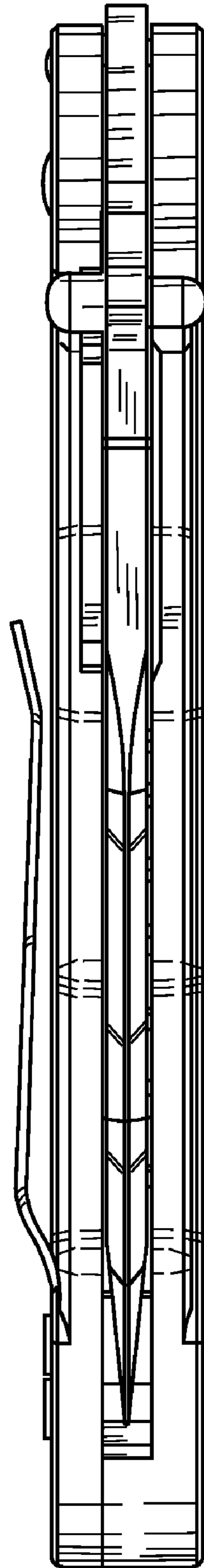

FIG. 12

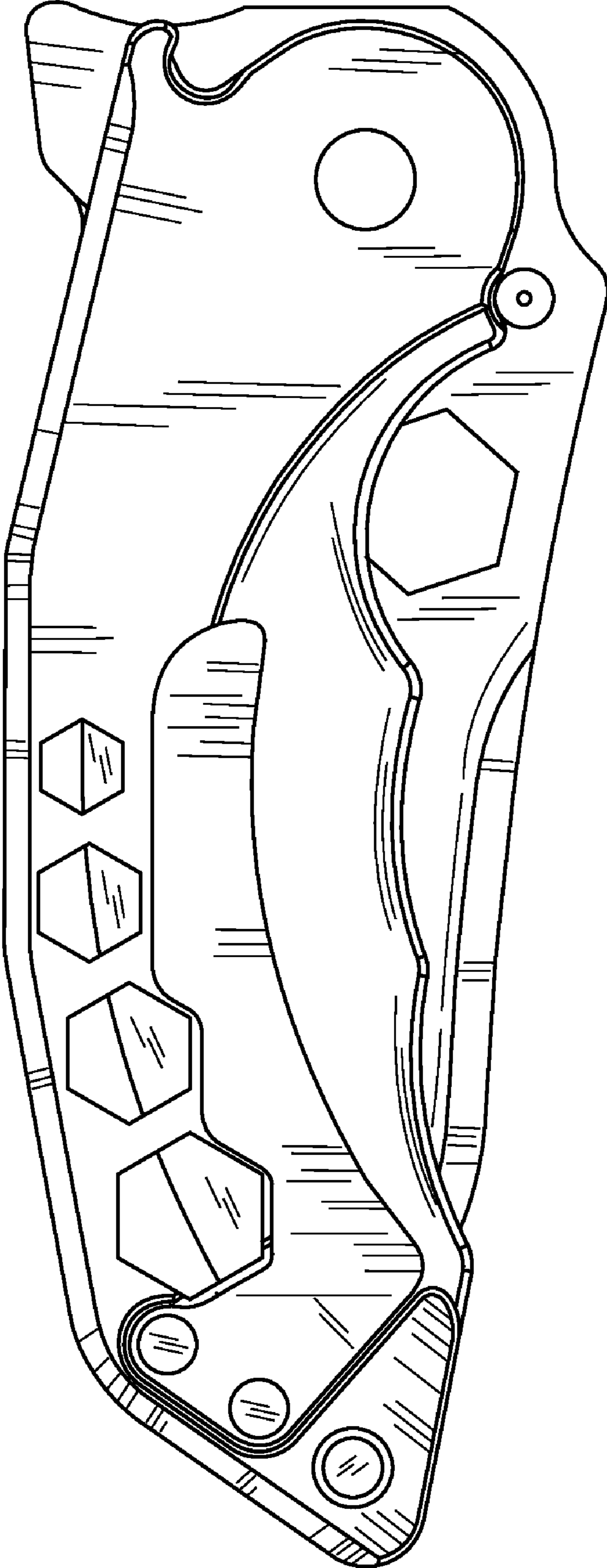

FIG. 13

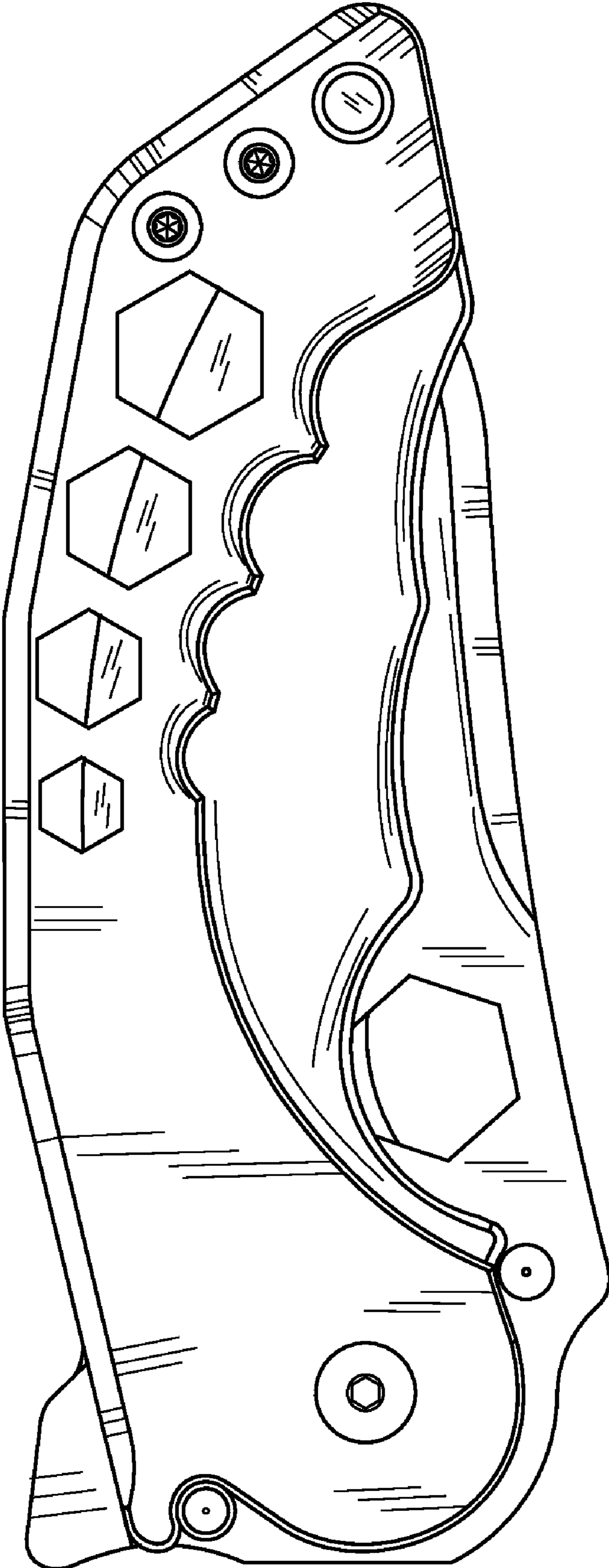

FIG. 14

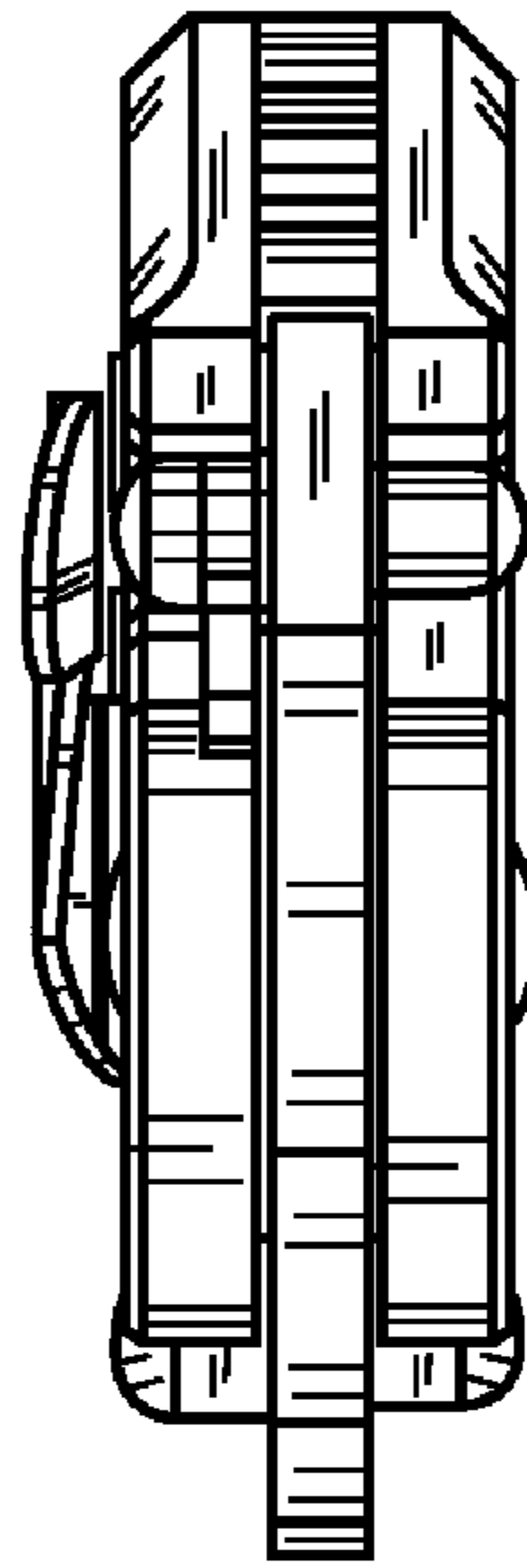

FIG. 15

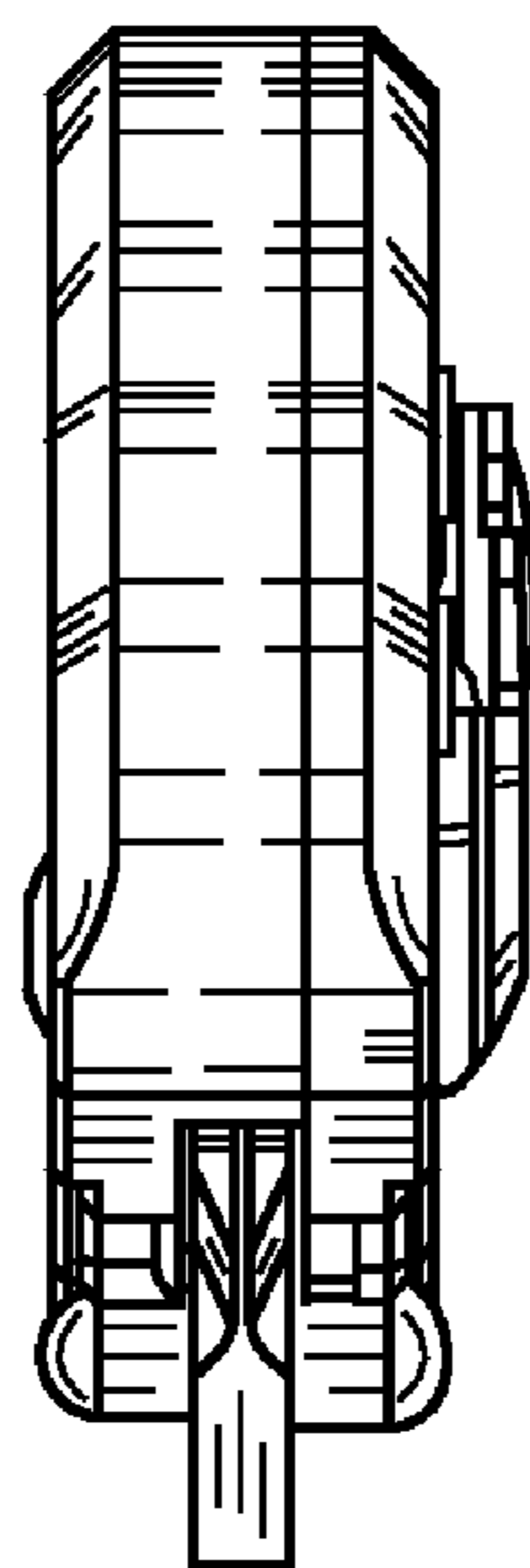

FIG. 16