



US00D634154S

(12) **United States Design Patent**
Agnello et al.

(10) **Patent No.:** **US D634,154 S**
(45) **Date of Patent:** **** Mar. 15, 2011**

(54) **CONVEYOR TOASTER WITH AIR-COOLED SIDES**

(75) Inventors: **Frank Anthony Agnello**, South Elgin, IL (US); **Loren Veltrop**, Chicago, IL (US); **Michael Soldwisch**, Glen Ellyn, IL (US); **Thomas Serena**, Palatine, IL (US)

(73) Assignee: **Prince Castle LLC**, Carol Stream, IL (US)

(**) Term: **14 Years**

(21) Appl. No.: **29/361,835**

(22) Filed: **May 15, 2010**

(51) **LOC (9) Cl.** **07-02**

(52) **U.S. Cl.** **D7/328; D7/330**

(58) **Field of Classification Search** D7/323, D7/328-334, 340-341, 346, 350.1-350.4, D7/351, 354-365, 367, 390, 402, 405-411; 99/326-327, 331-332, 341, 357, 375, 385-392; 219/385-388, 398, 400, 405, 443.1, 450.1, 219/489, 492, 532; 426/233, 523
See application file for complete search history.

(56) **References Cited**

U.S. PATENT DOCUMENTS

3,336,858 A * 8/1967 Maindonald 99/391
D222,514 S * 10/1971 Joeckel D7/350.4
4,286,509 A 9/1981 Miller et al.

4,530,276 A 7/1985 Miller
D330,144 S * 10/1992 Takebata et al. D7/351
D371,274 S * 7/1996 Sitaras D7/350.4
5,960,704 A 10/1999 March et al.
6,114,663 A * 9/2000 Stockley 219/398
6,192,789 B1 2/2001 Agcaoili et al.
D541,578 S * 5/2007 Jeon D7/350.1
7,297,903 B1 11/2007 March et al.
7,372,000 B2 * 5/2008 Stockley 219/400
D603,649 S * 11/2009 Chung et al. D7/330
D605,891 S * 12/2009 Kizilbayir D7/330
D609,958 S * 2/2010 Chung et al. D7/330

* cited by examiner

Primary Examiner — Ricky Pham

(74) *Attorney, Agent, or Firm* — Joseph P. Krause

(57) **CLAIM**

The ornamental design for a conveyor toaster with air-cooled sides, as shown and described.

DESCRIPTION

FIG. 1 is a perspective view of a conveyor toaster with air-cooled sides, showing our new design;
FIG. 2 is a top view thereof;
FIG. 3 is a right end view thereof;
FIG. 4 is a left end view thereof;
FIG. 5 is a bottom view thereof;
FIG. 6 is a rear view thereof; and,
FIG. 7 is a front view thereof.

The broken lines represent unclaimed boundaries of the design. The shading lines are for illustrative purposes only and form no part of the claimed design.

1 Claim, 4 Drawing Sheets

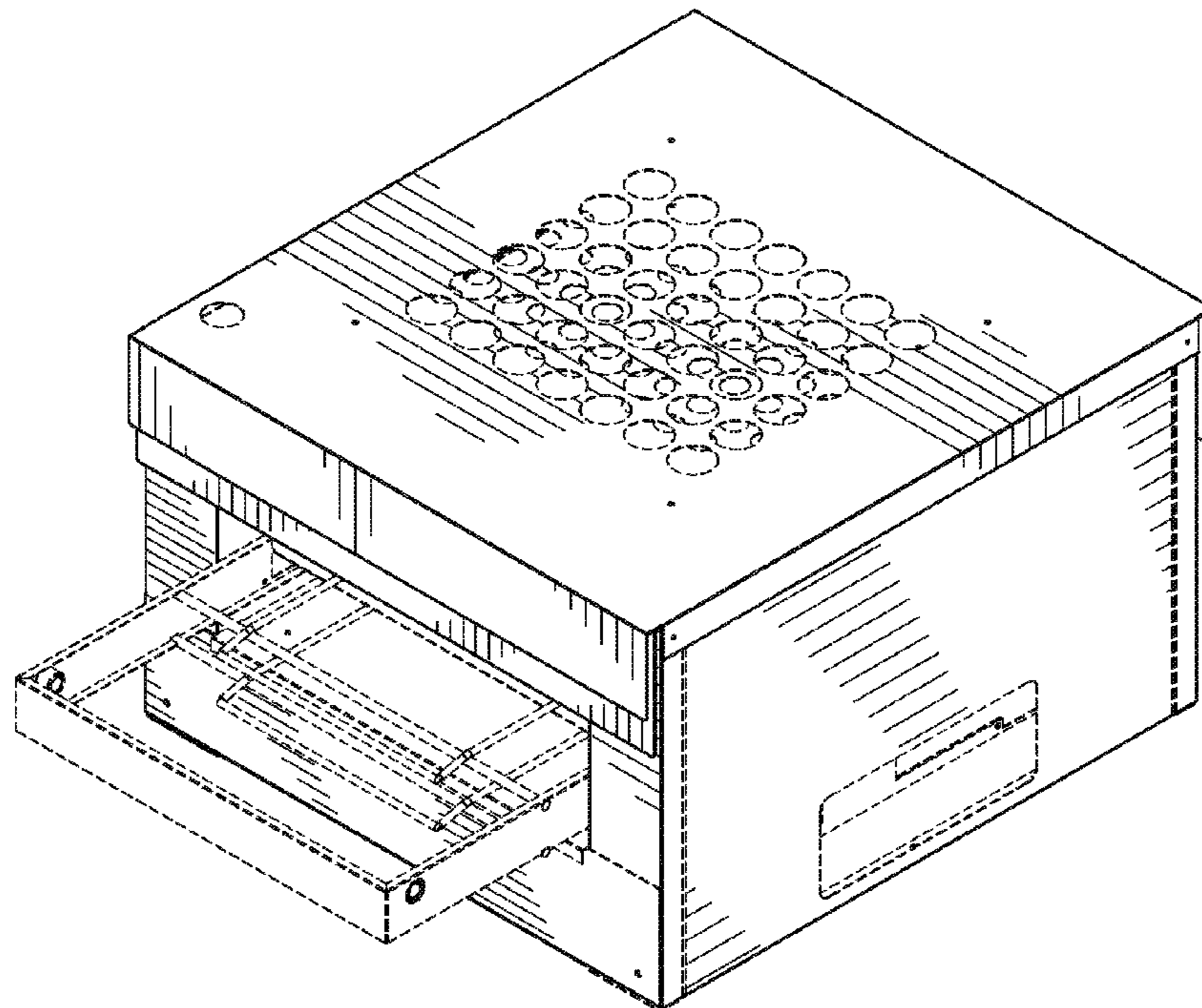

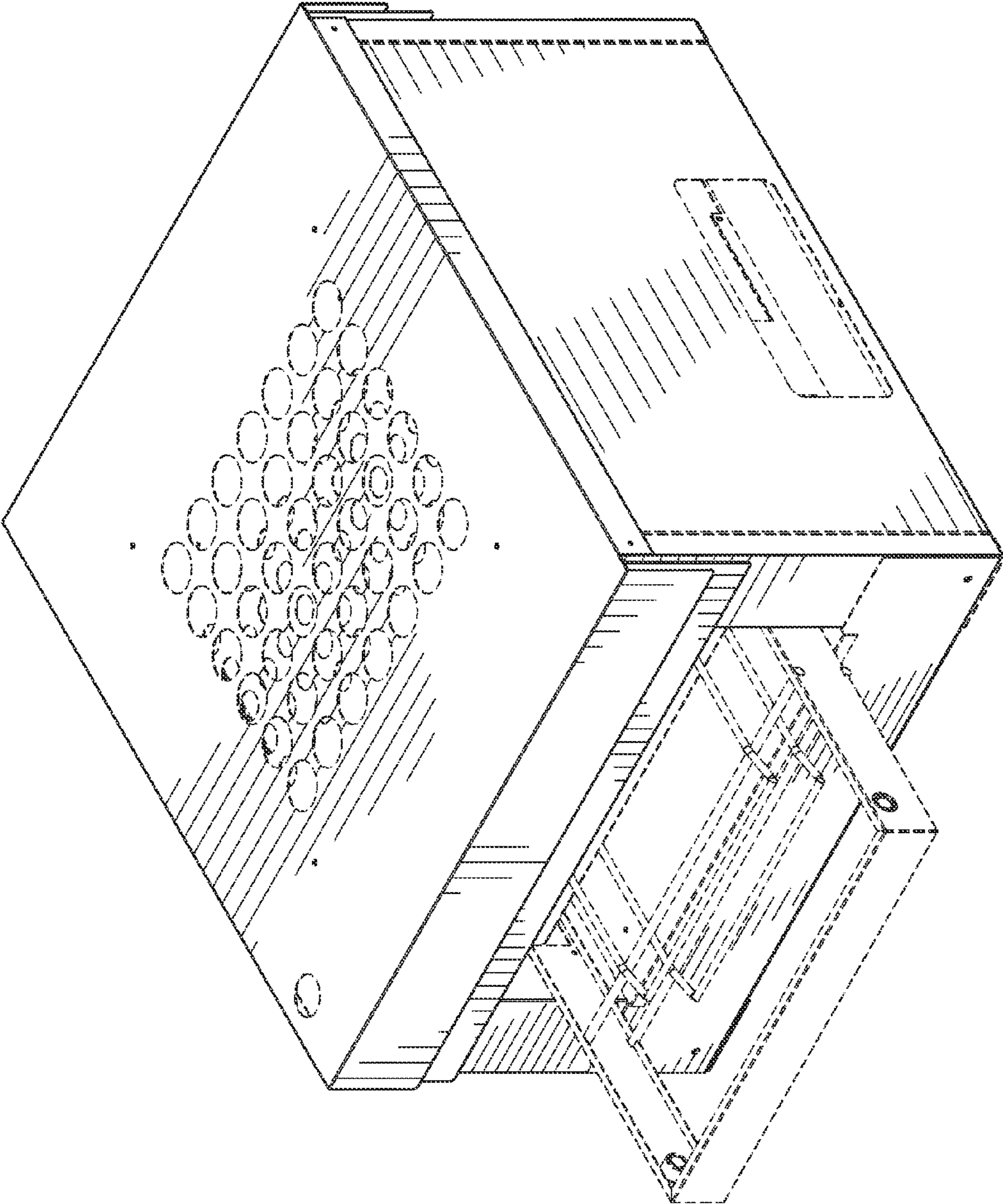

FIG. 1

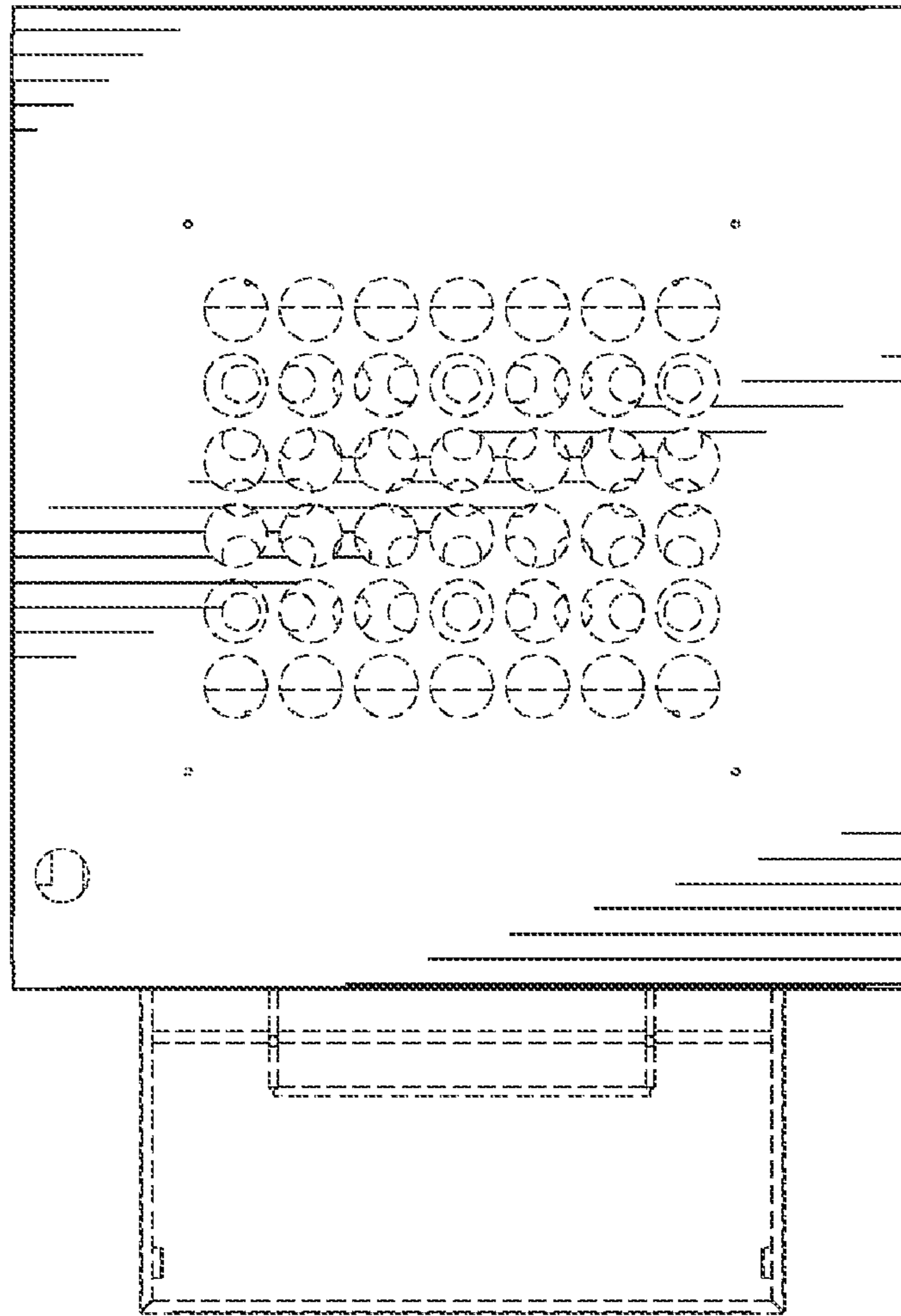

FIG. 2

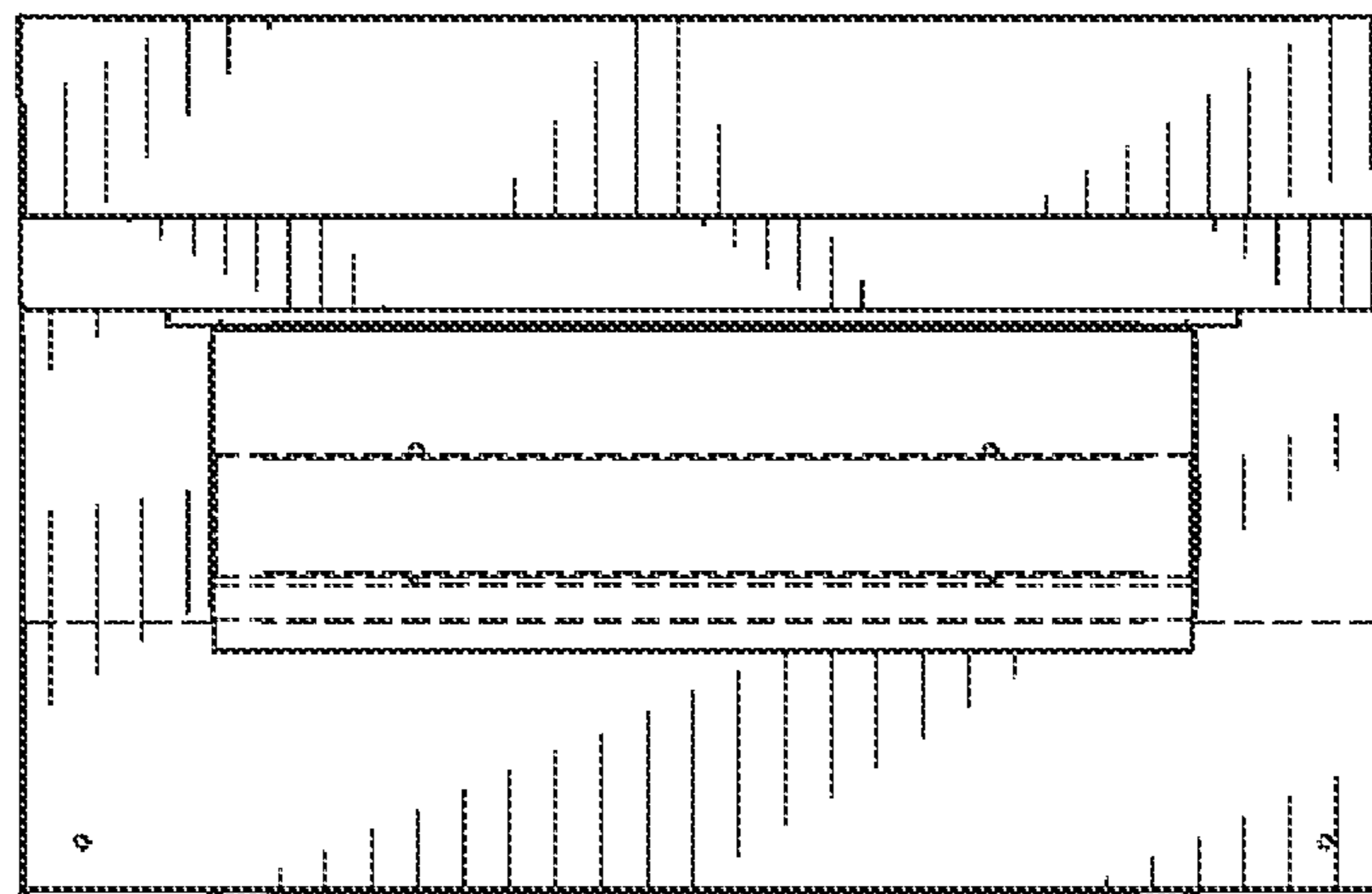

FIG. 3

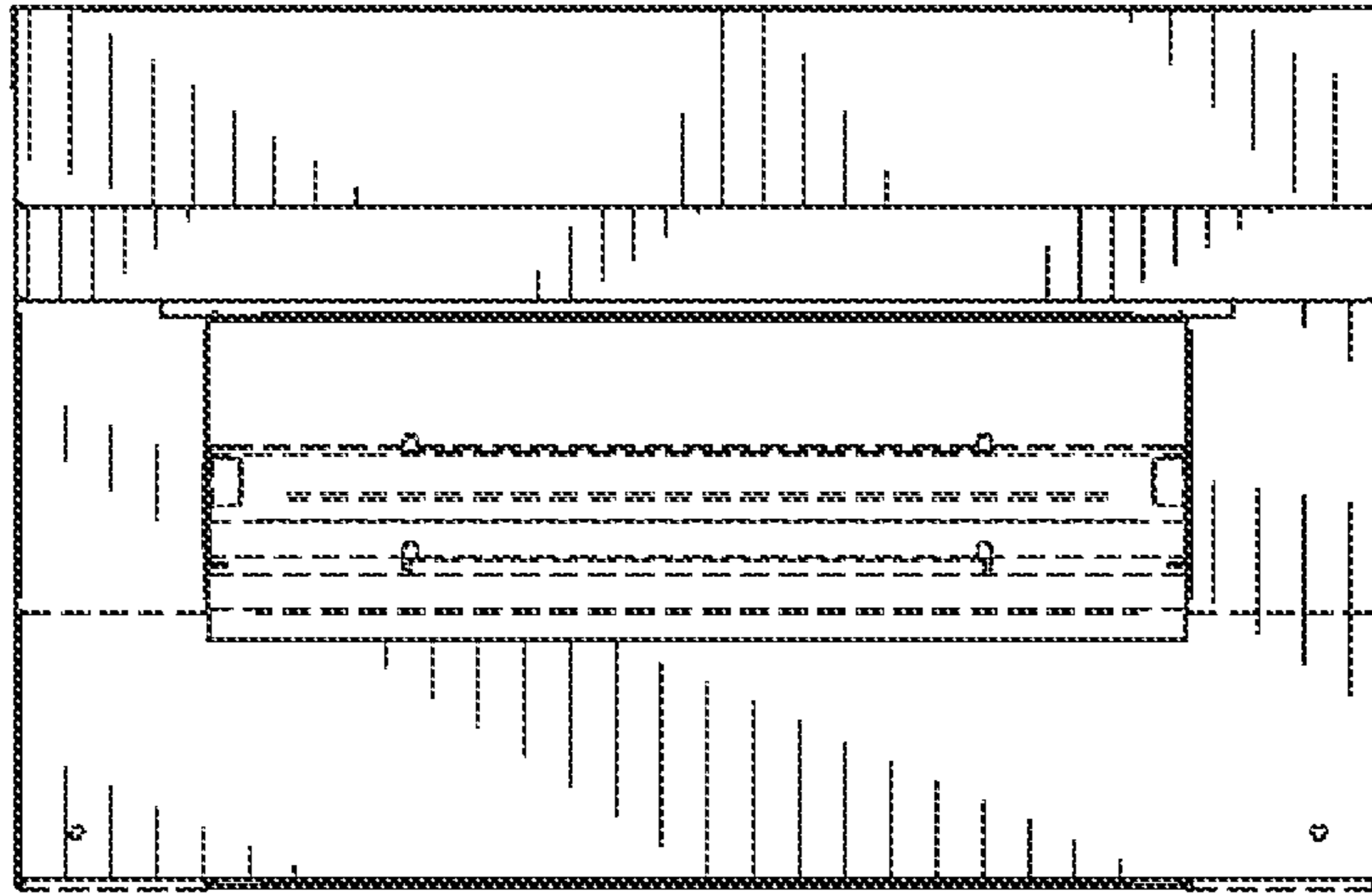

FIG. 4

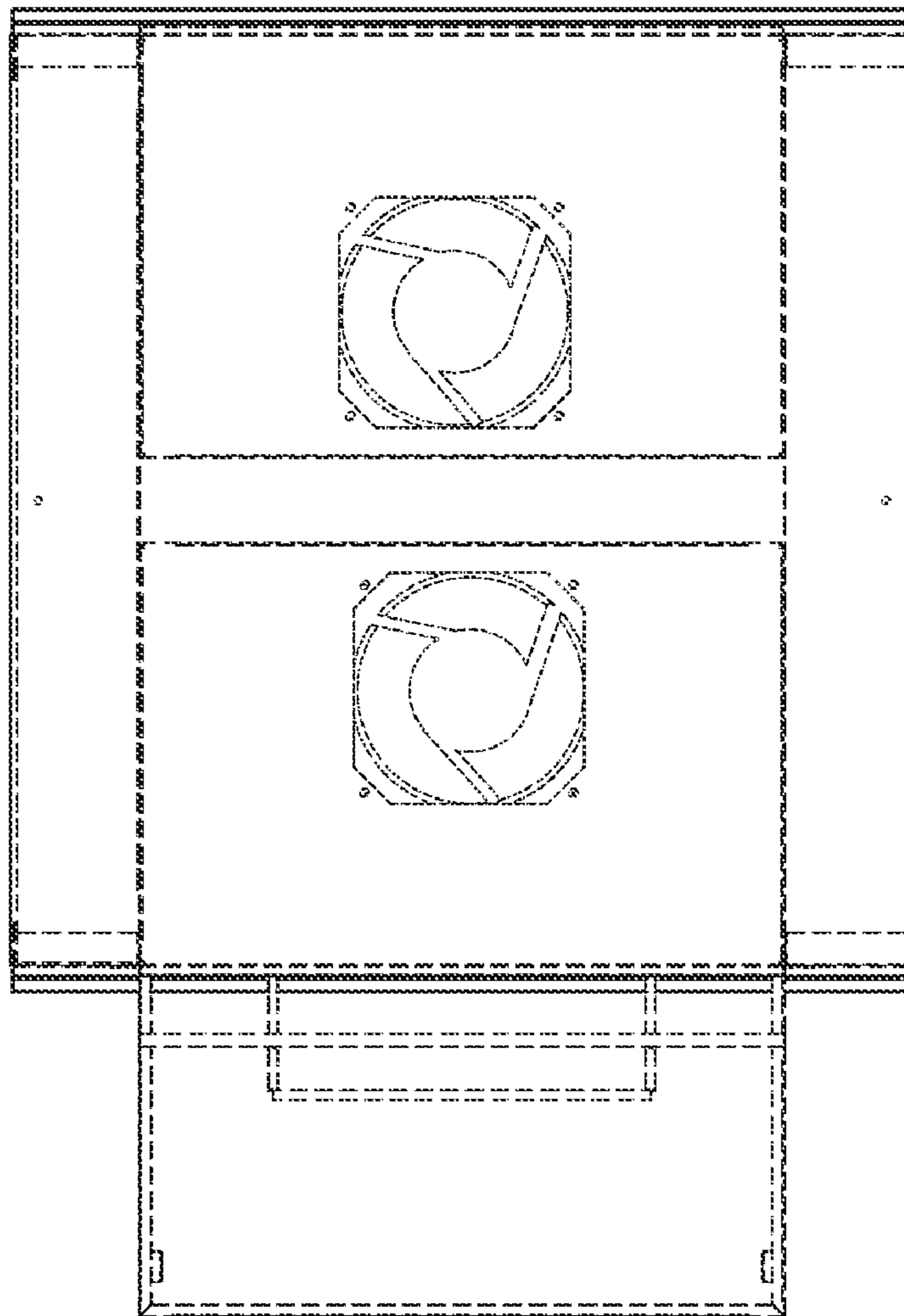

FIG. 5

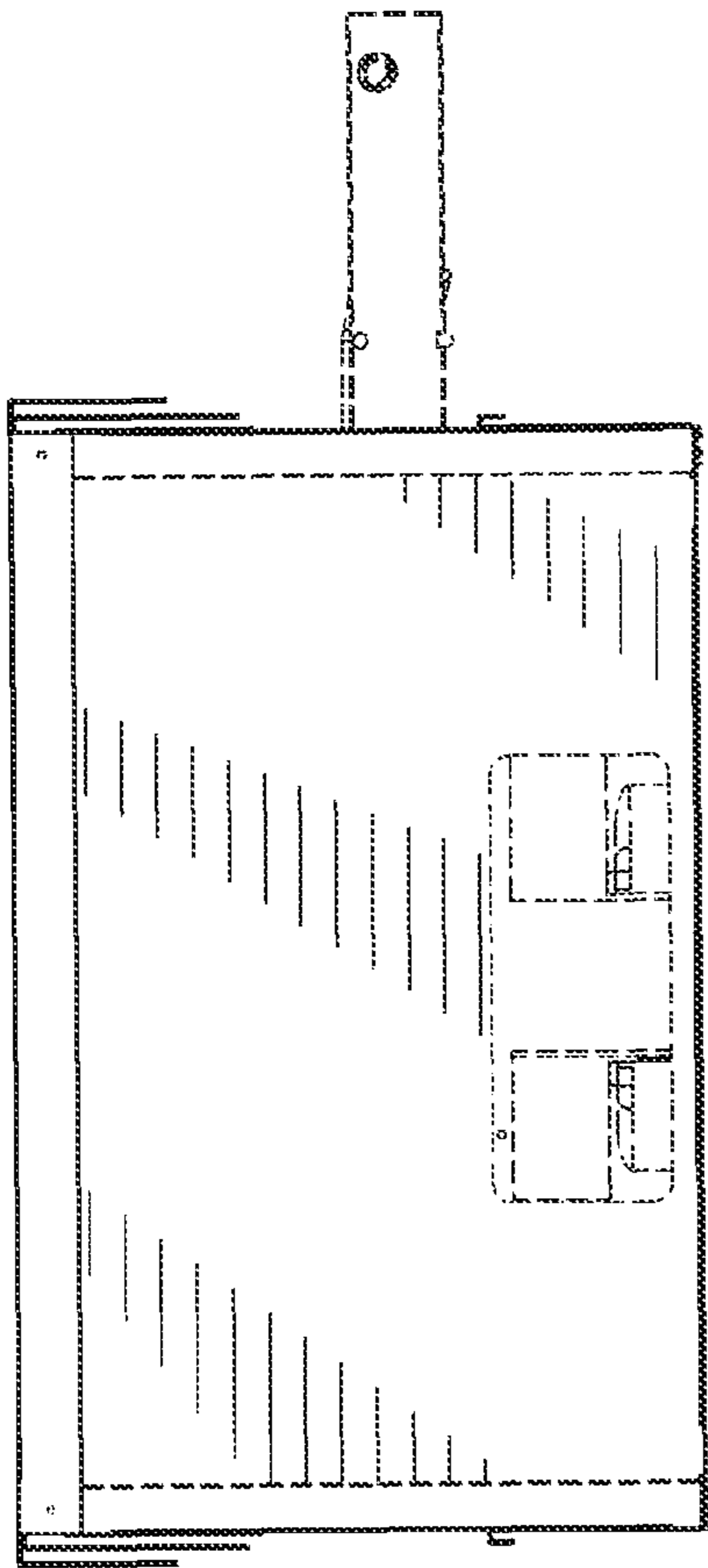

FIG. 6

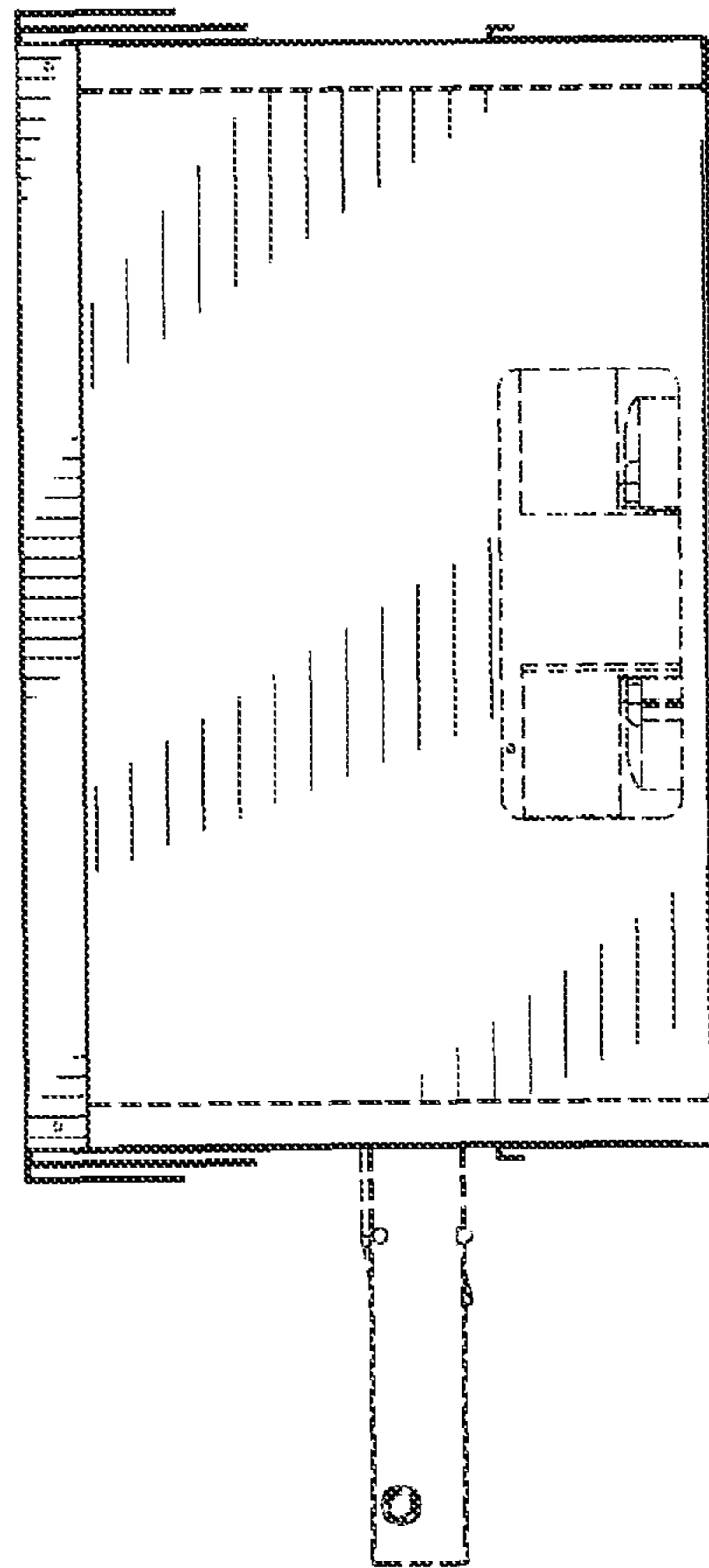

FIG. 7