



US00D634140S

(12) **United States Design Patent**
Camacho-Pantoja

(10) **Patent No.:** **US D634,140 S**
(45) **Date of Patent:** **** Mar. 15, 2011**

- (54) **HYGIENIC TOOTHBRUSH HOLDER**
- (76) Inventor: **Jose A. Camacho-Pantoja**, Stamford, CT (US)
- (**) Term: **14 Years**
- (21) Appl. No.: **29/357,862**
- (22) Filed: **Mar. 18, 2010**
- (51) **LOC (9) Cl.** **23-02**
- (52) **U.S. Cl.** **D6/534**
- (58) **Field of Classification Search** D6/524, D6/526, 527, 528, 534, 553, 567; 206/208, 206/228, 209, 209.1, 361, 362, 362.1, 362.2, 206/362.3; 211/13.1, 66, 70.6, 86.01, 87.01
See application file for complete search history.

(56) **References Cited**

U.S. PATENT DOCUMENTS

1,102,284	A	7/1914	Miller	
1,959,600	A	5/1934	Schneider et al.	
1,995,972	A	3/1935	Ehrlich	
3,194,621	A *	7/1965	Frost	D6/534
4,214,657	A *	7/1980	Winston	D6/534
4,473,152	A	9/1984	Jump, Jr. et al.	
D299,481	S *	1/1989	Handler et al.	D6/534
5,035,385	A	7/1991	Markham	
D382,430	S *	8/1997	Thomas	D6/534
D396,762	S *	8/1998	Bermillo	D6/534
D424,855	S	5/2000	Murphy	
D456,217	S *	4/2002	Hawkins et al.	D6/567
6,530,502	B2	3/2003	Neal	
D481,572	S *	11/2003	Dretzka	D6/534
D527,560	S *	9/2006	Bar Noy	D6/534
D538,091	S *	3/2007	Roth	D6/534
D543,749	S *	6/2007	Emmons	D6/534
D604,975	S *	12/2009	Racanelli	D6/534

* cited by examiner

Primary Examiner — Brian N Vinson

(74) *Attorney, Agent, or Firm* — St. Onge Steward Johnston & Reens LLC

(57) **CLAIM**

The ornamental design for a hygienic toothbrush holder, as shown and described.

DESCRIPTION

FIG. 1 is a front, top and right side perspective view of a first embodiment of a hygienic toothbrush holder showing my new design;

FIG. 2 is a front elevational view thereof;

FIG. 3 is a right side elevational view thereof, the left side being a mirror image of that shown;

FIG. 4 is a rear elevational view thereof;

FIG. 5 is a top plan view thereof;

FIG. 6 is a bottom plan view thereof;

FIG. 7 is front, top, and right side perspective view of the hanger strip portion of the first embodiment thereof, the holder portion being omitted for clarity of illustration;

FIG. 8 is a front, top and right side perspective view of a second embodiment of a hygienic toothbrush holder showing my new design;

FIG. 9 is a front elevational view thereof;

FIG. 10 is a right side elevational view thereof, the left side being a mirror image of that shown;

FIG. 11 is a rear elevational view thereof;

FIG. 12 is a top plan view thereof;

FIG. 13 is a bottom plan view thereof;

FIG. 14 is front, top, and right side perspective view of the hanger strip portion of the second embodiment thereof, the holder portion being omitted for clarity of illustration;

FIG. 15 is a front, top and right side perspective view of a third embodiment of a hygienic toothbrush holder showing my new design;

FIG. 16 is a front elevational view thereof;

FIG. 17 is a right side elevational view thereof, the left side being a mirror image of that shown;

FIG. 18 is a rear elevational view thereof;

FIG. 19 is a top plan view thereof;

FIG. 20 is a bottom plan view thereof;

FIG. 21 is front, top, and right side perspective view of the hanger strip portion of the third embodiment thereof, the holder portion being omitted for clarity of illustration;

FIG. 22 is a front, top and right side perspective view of a fourth embodiment of a hygienic toothbrush holder showing my new design;

FIG. 23 is a front elevational view thereof;

FIG. 24 is a right side elevational view thereof, the left side being a mirror image of that shown;

FIG. 25 is a rear elevational view thereof;

FIG. 26 is a top plan view thereof;

FIG. 27 is a bottom plan view thereof; and,

FIG. 28 is front, top, and right side perspective view of the hanger strip portion of the fourth embodiment thereof, the holder portion being omitted for clarity of illustration.

1 Claim, 28 Drawing Sheets

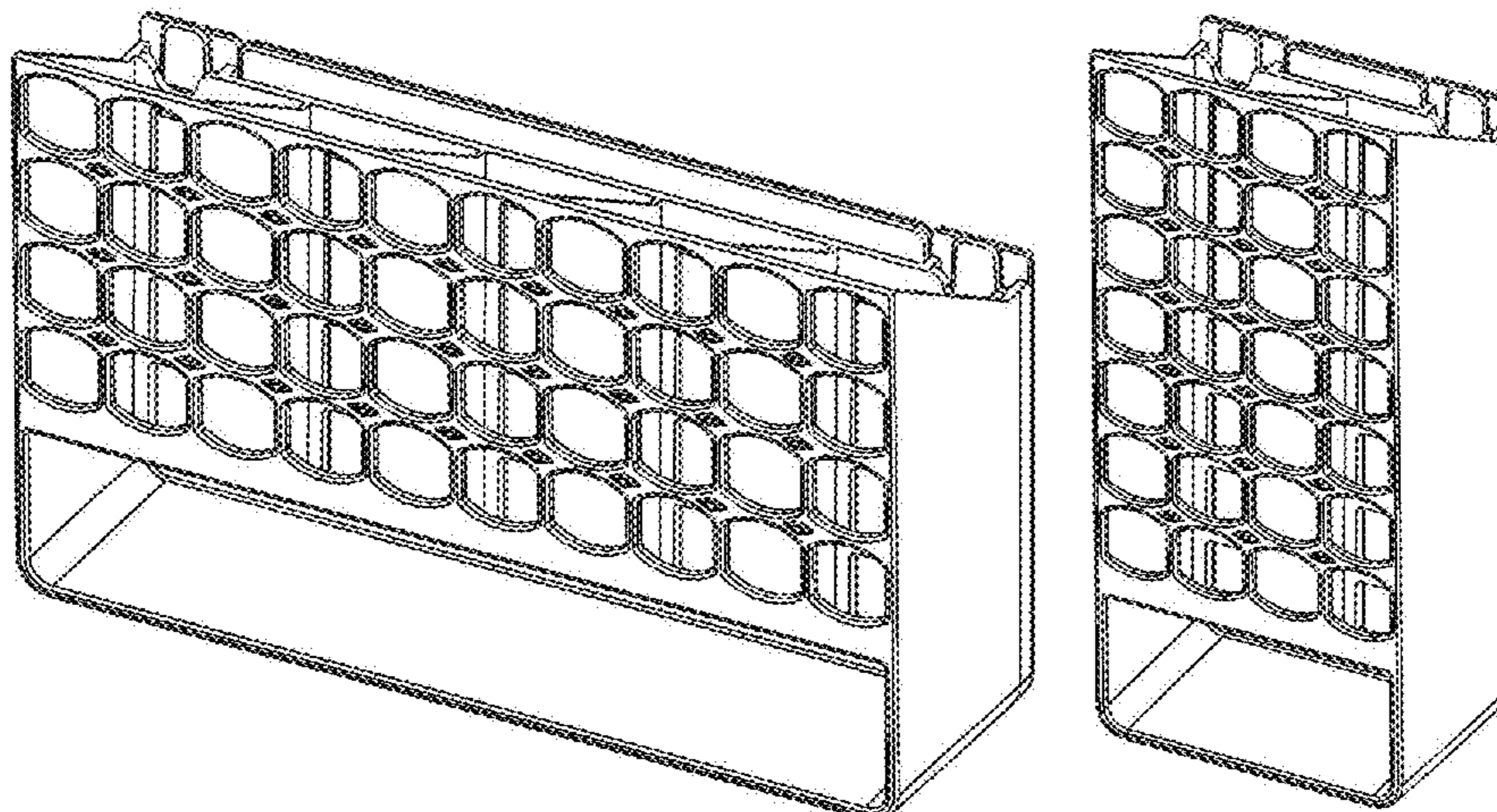

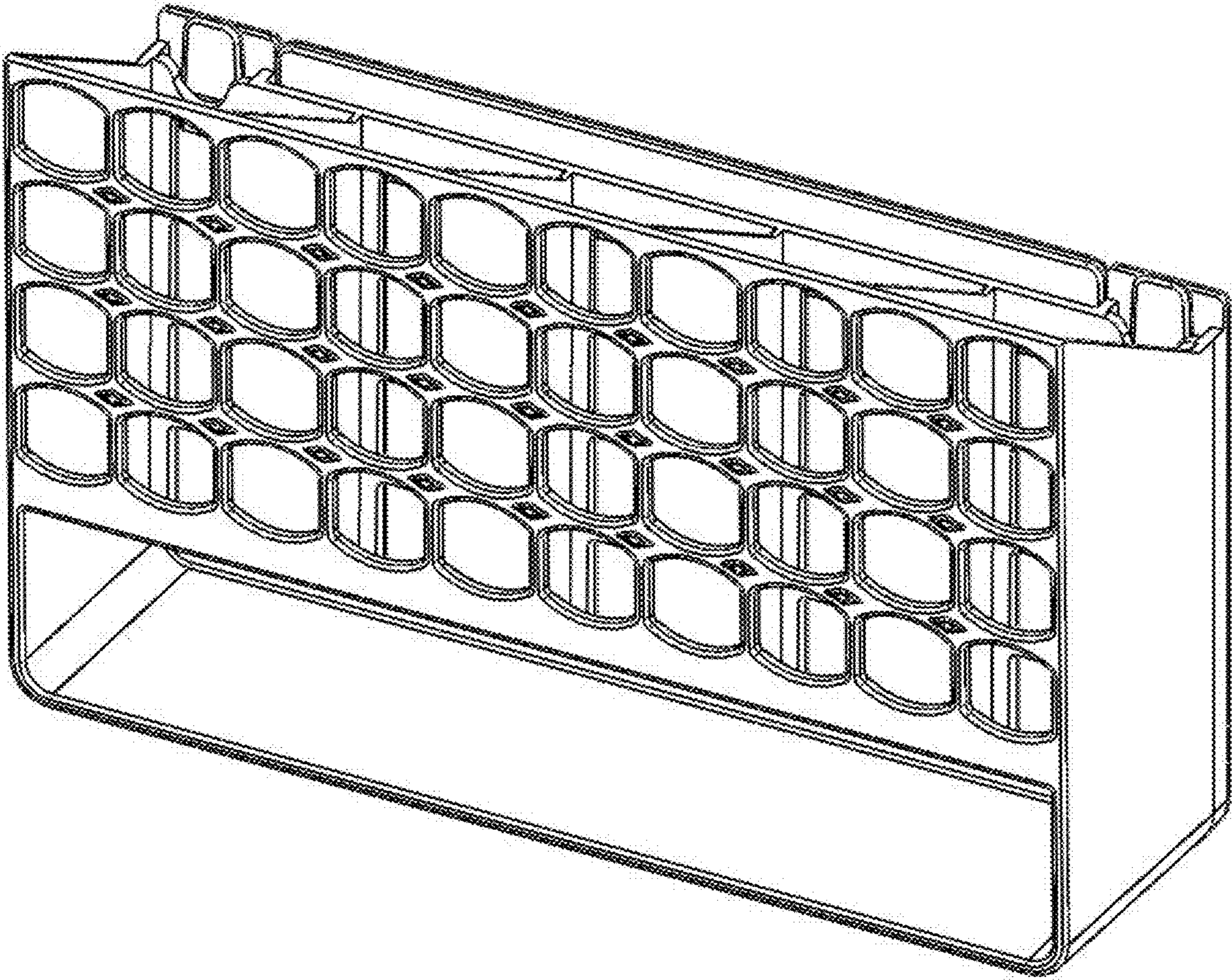

FIG. 1

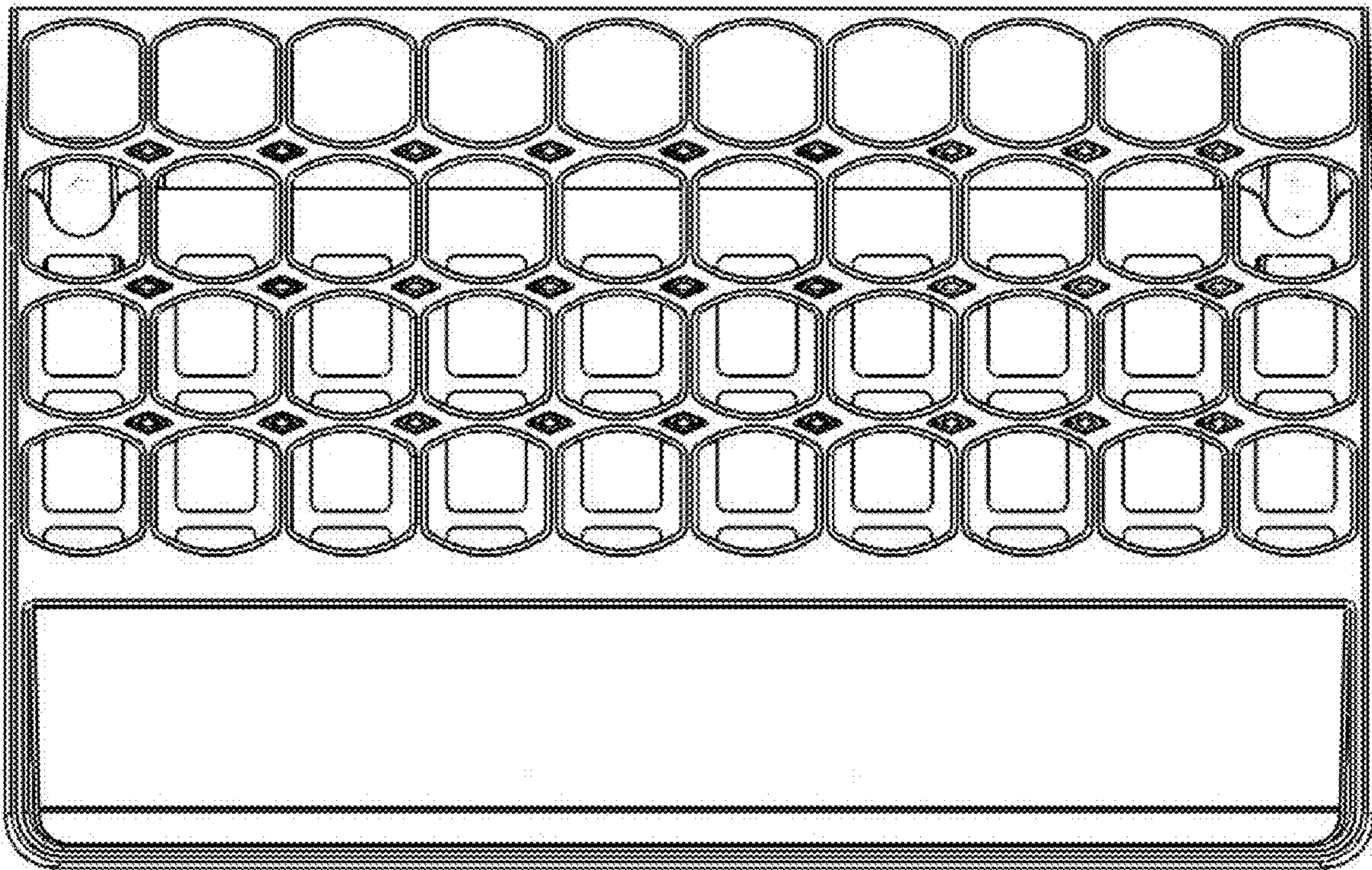

FIG. 2

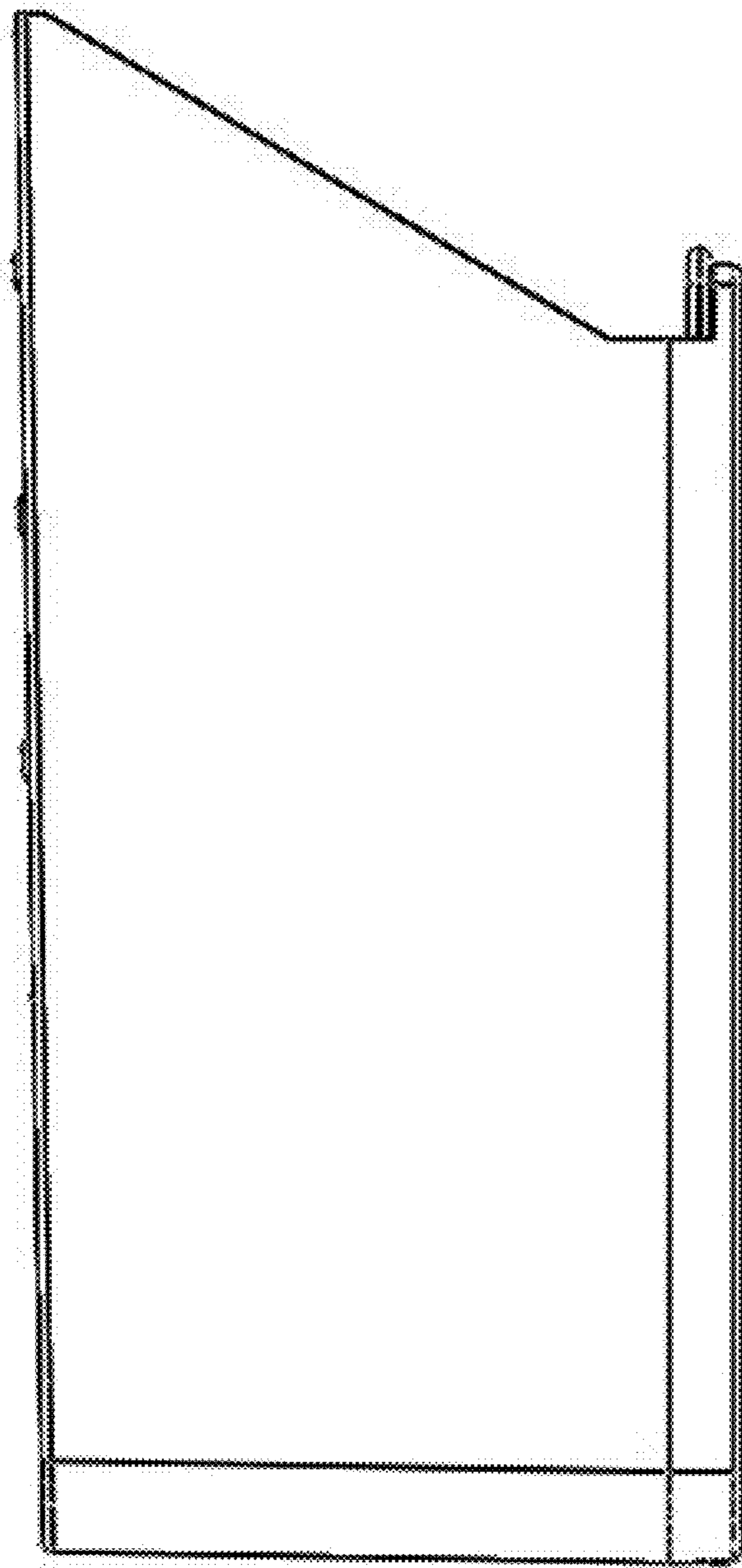

FIG. 3

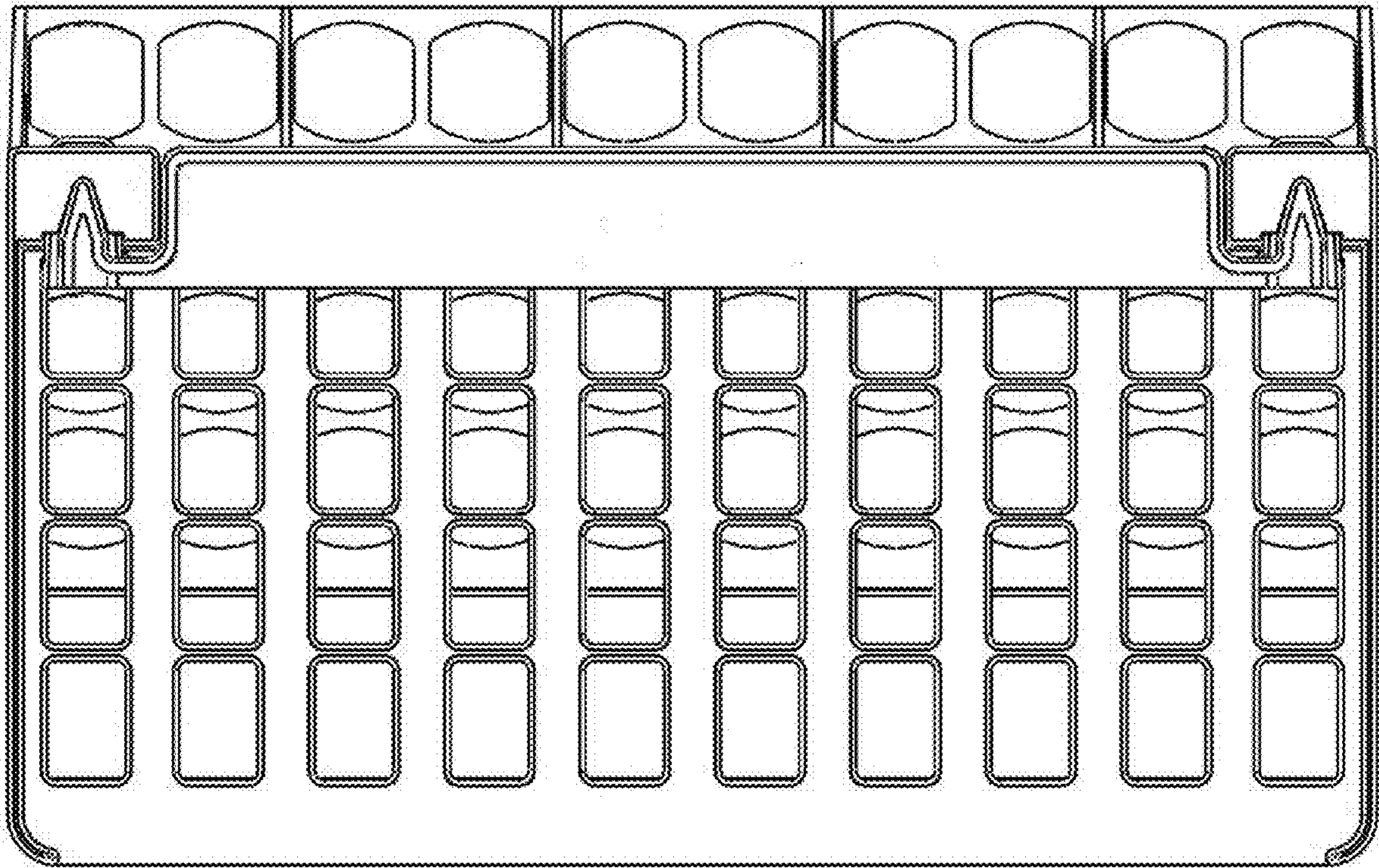

FIG. 4

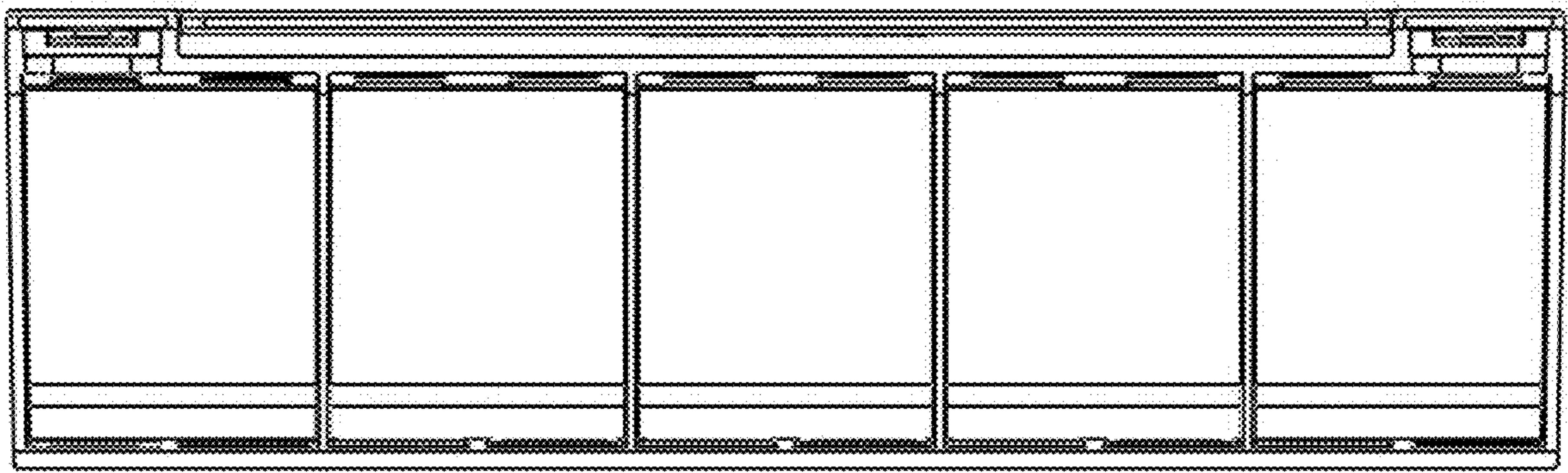

FIG. 5

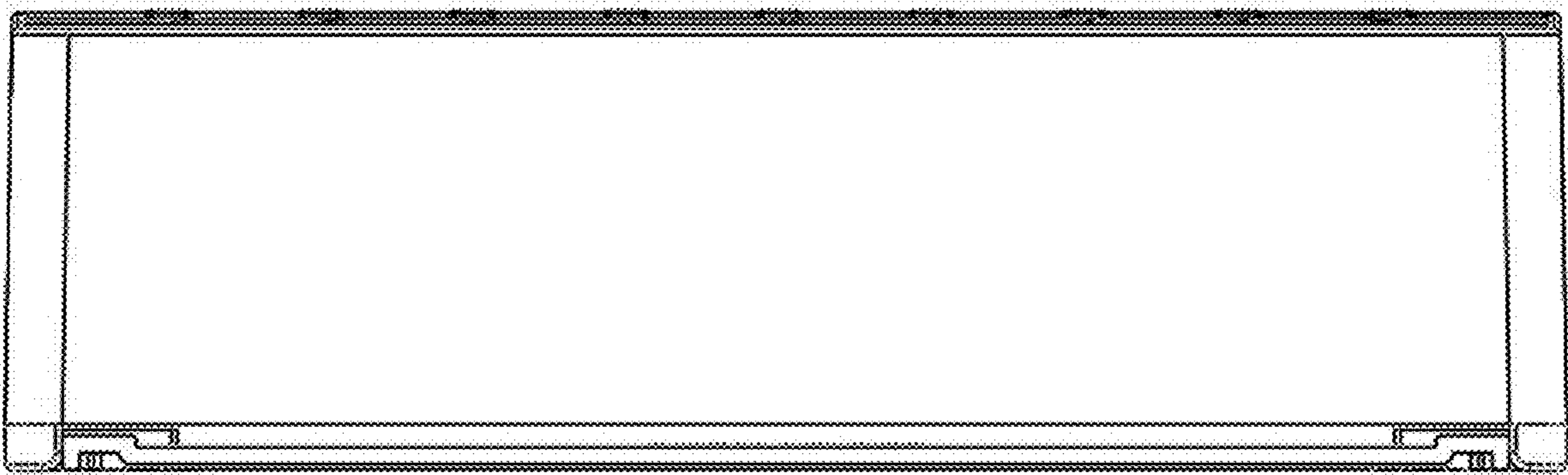

FIG. 6

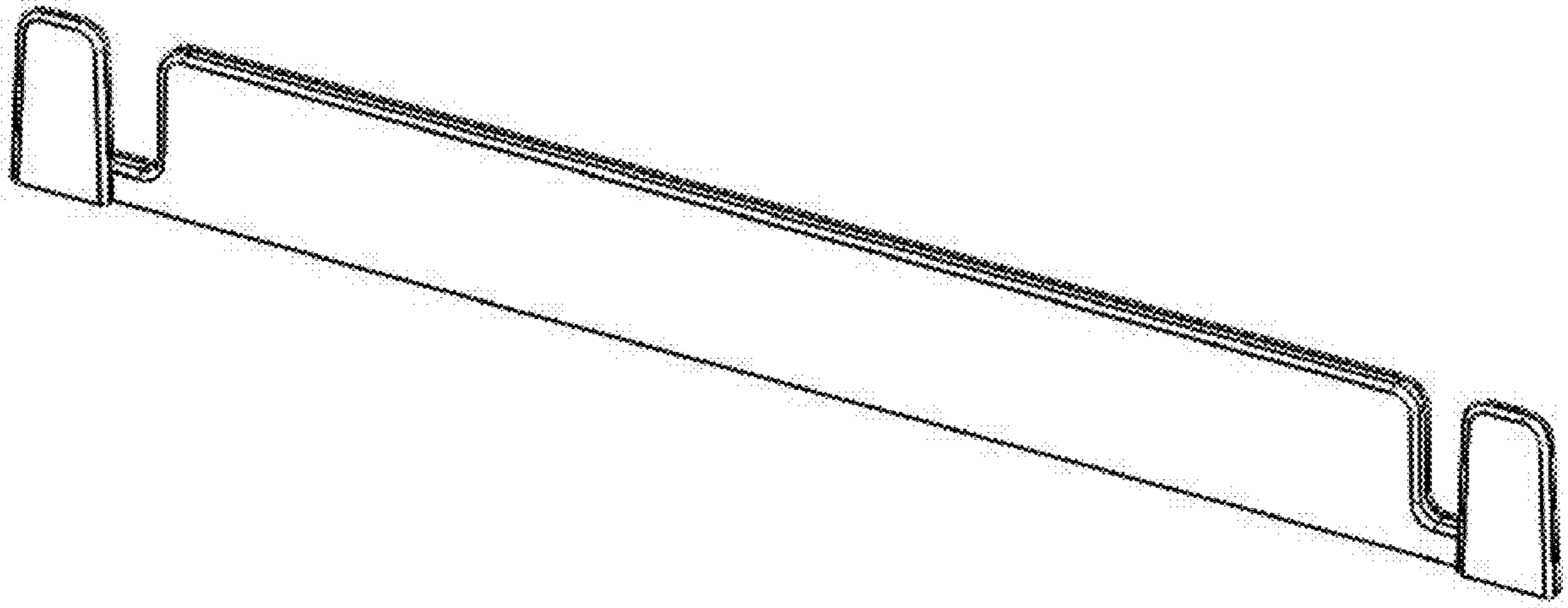

FIG. 7

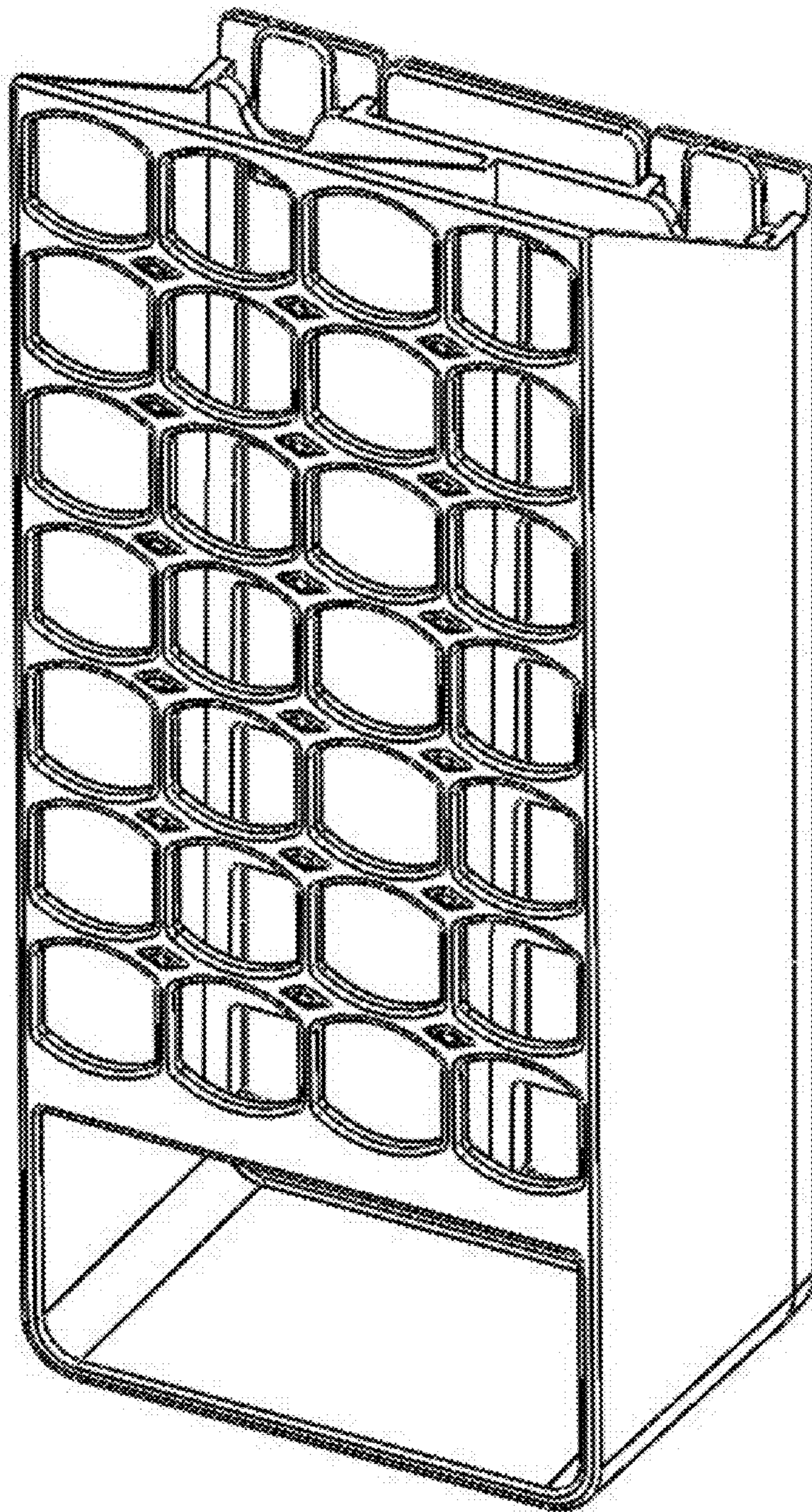

FIG. 8

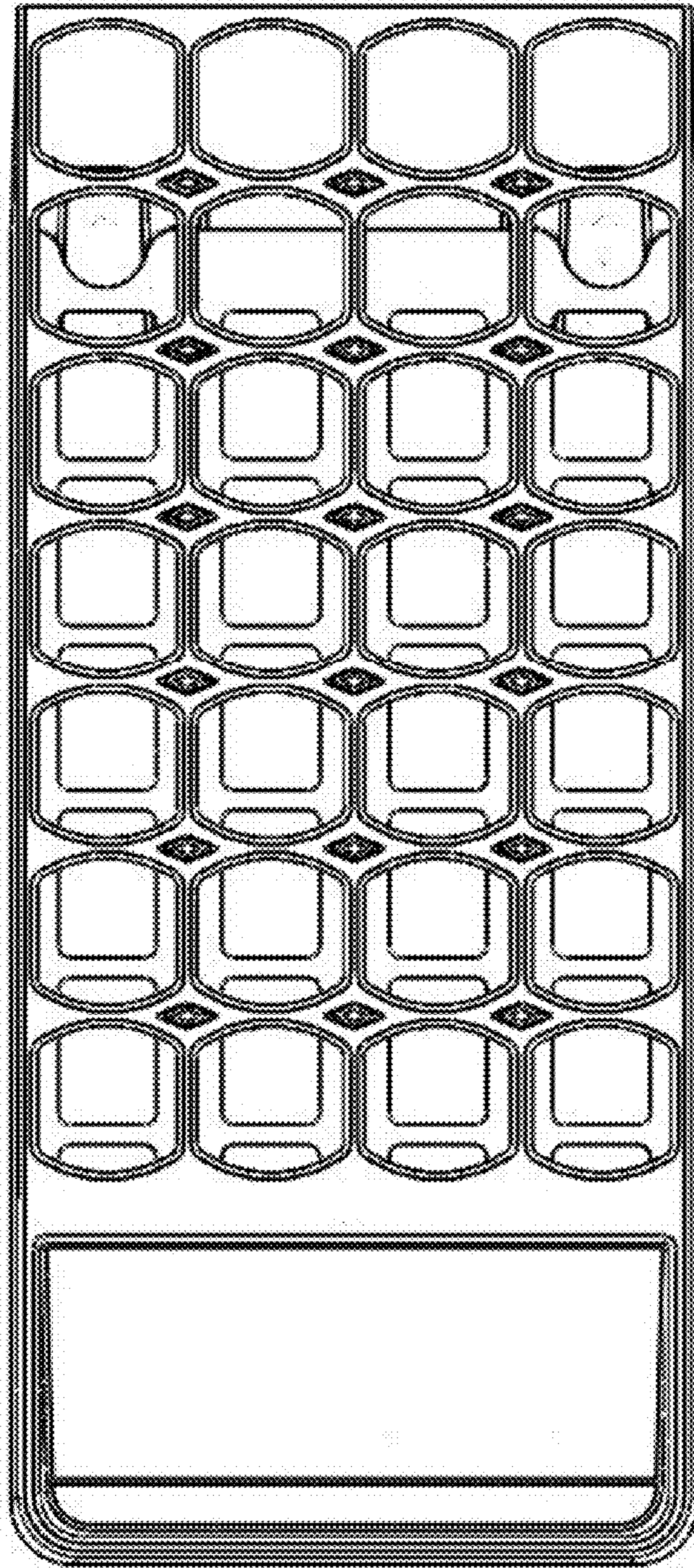

FIG. 9

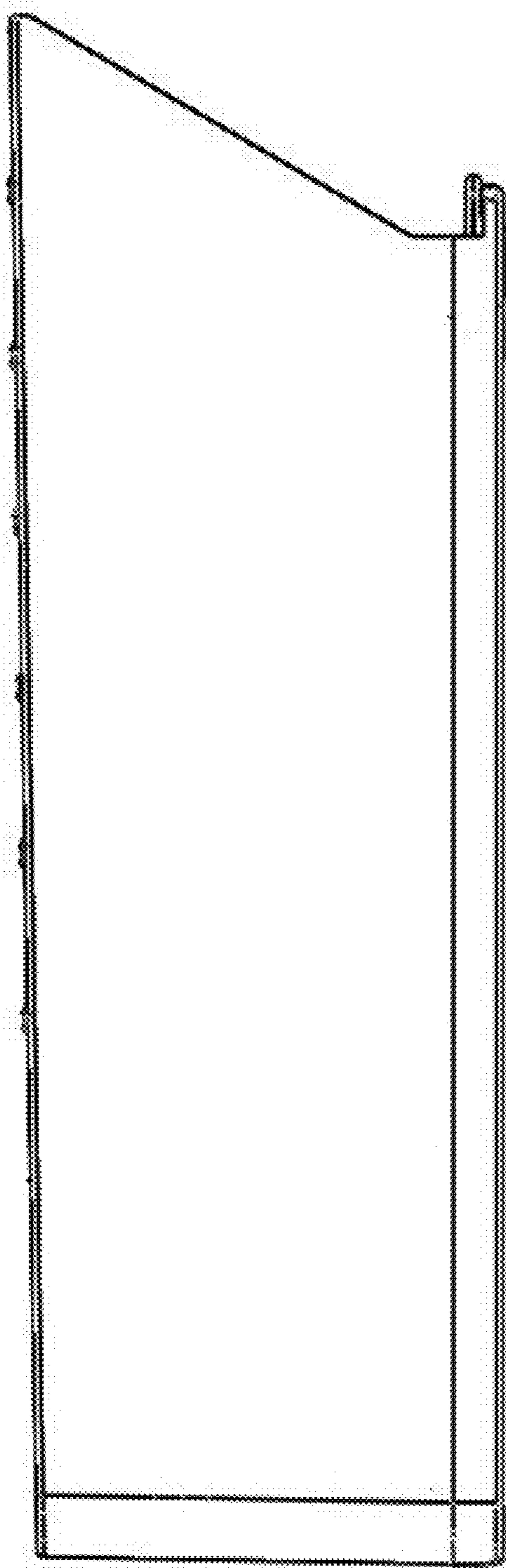

FIG. 10

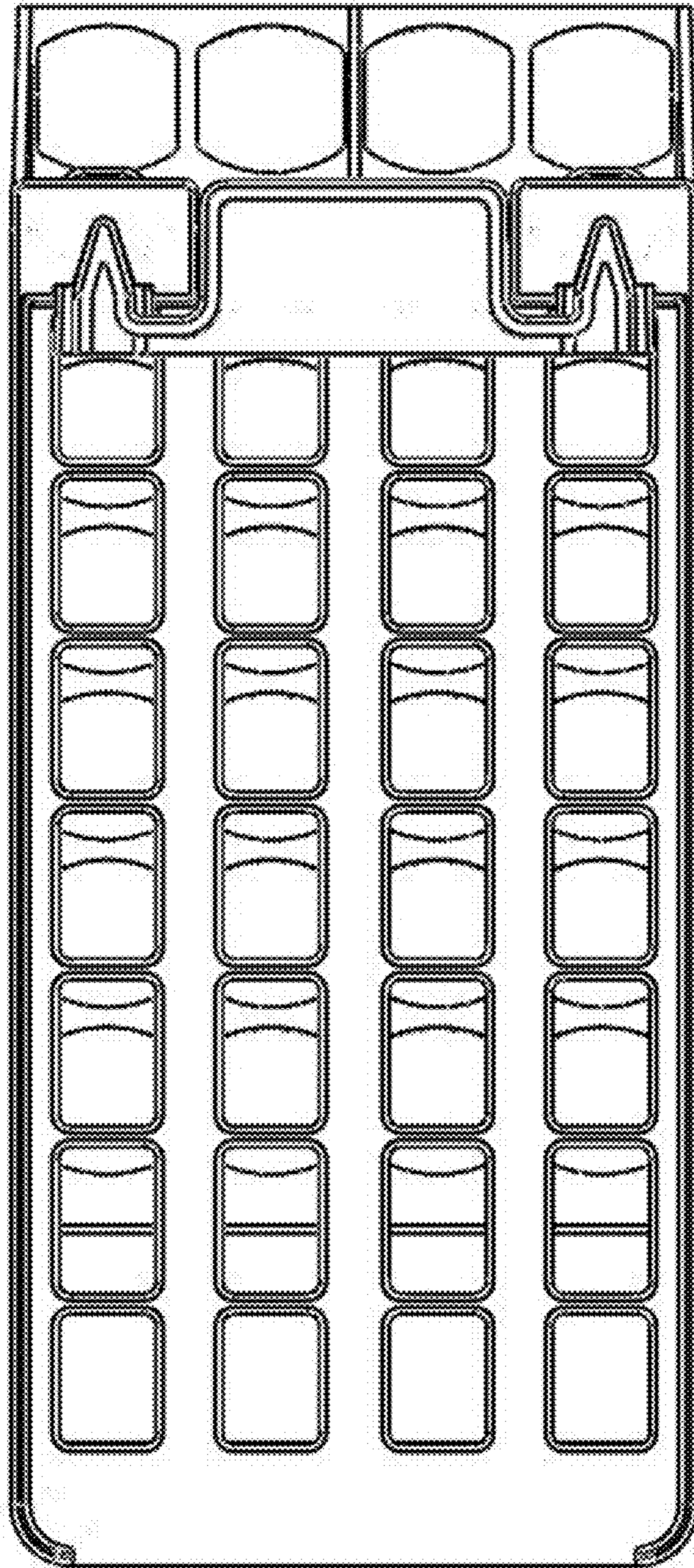

FIG. 11

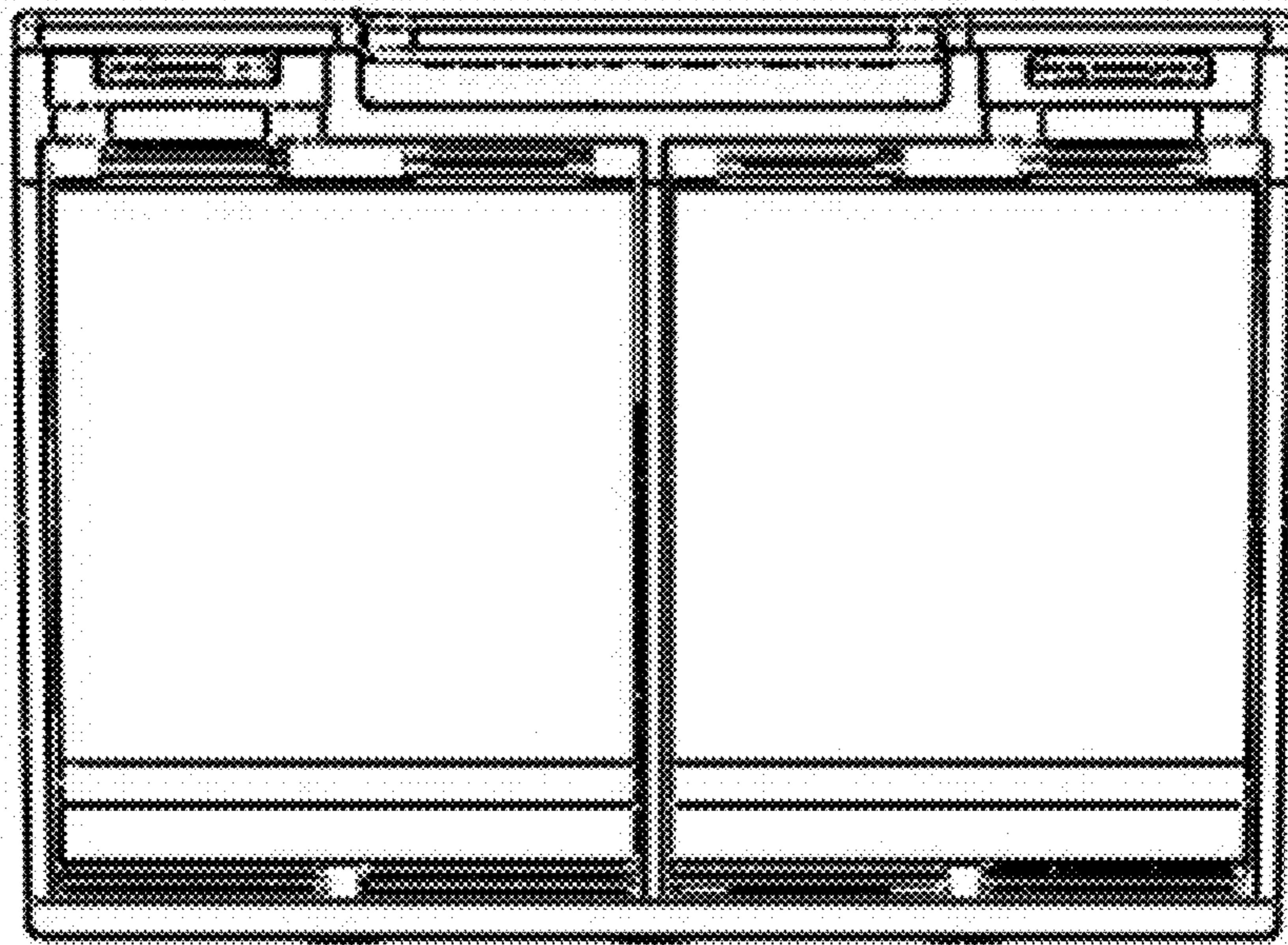

FIG. 12

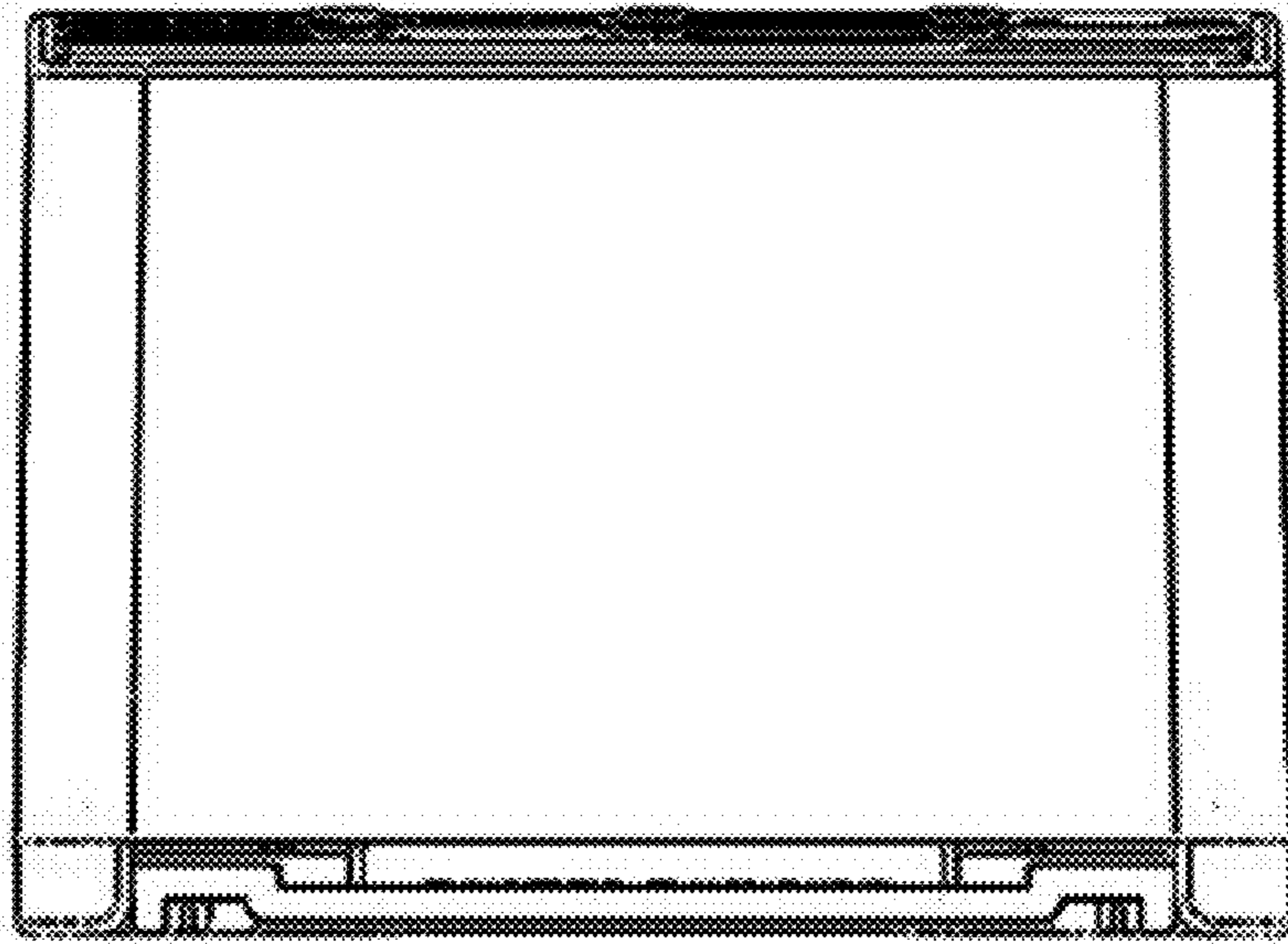

FIG. 13

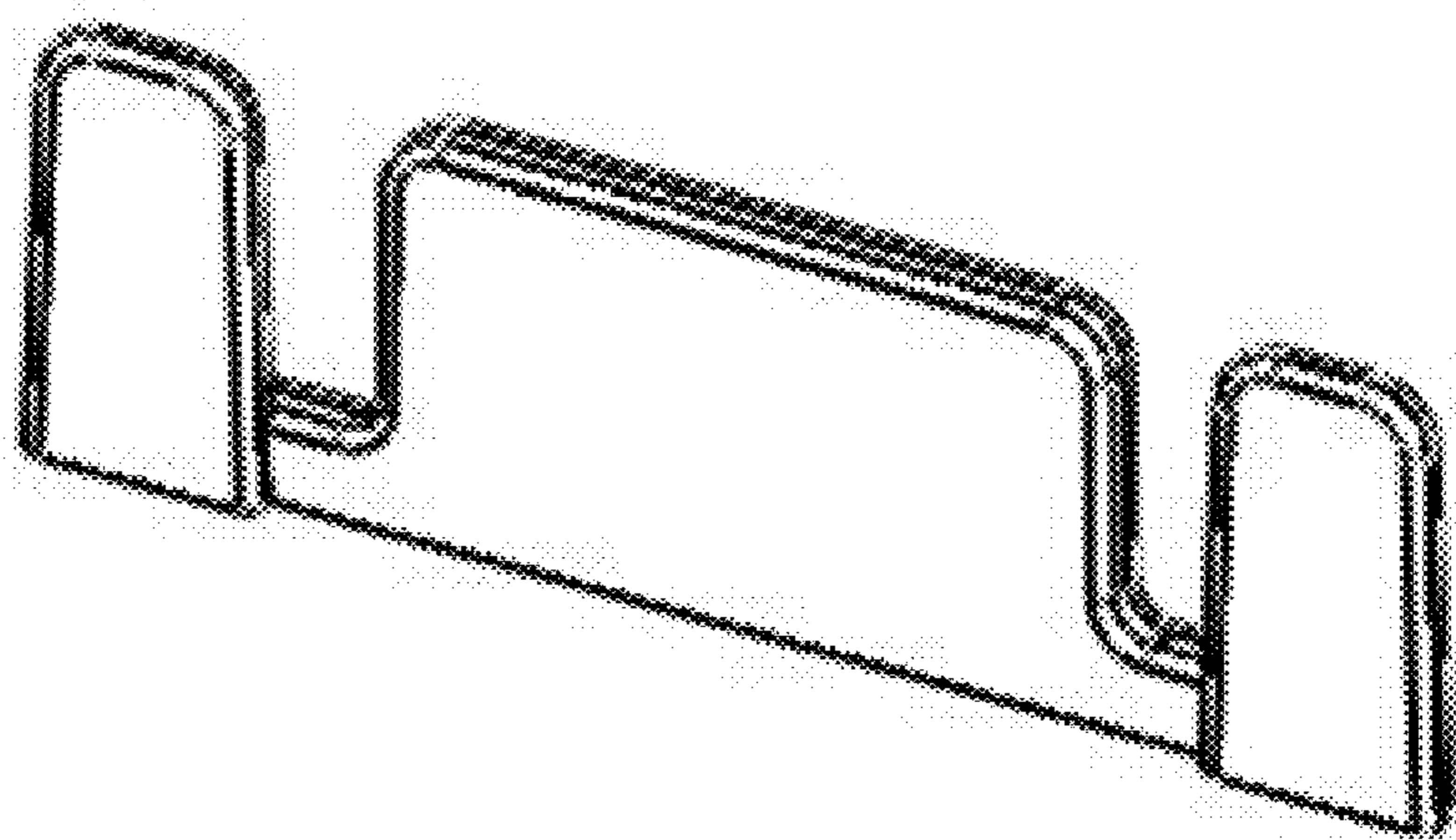

FIG. 14

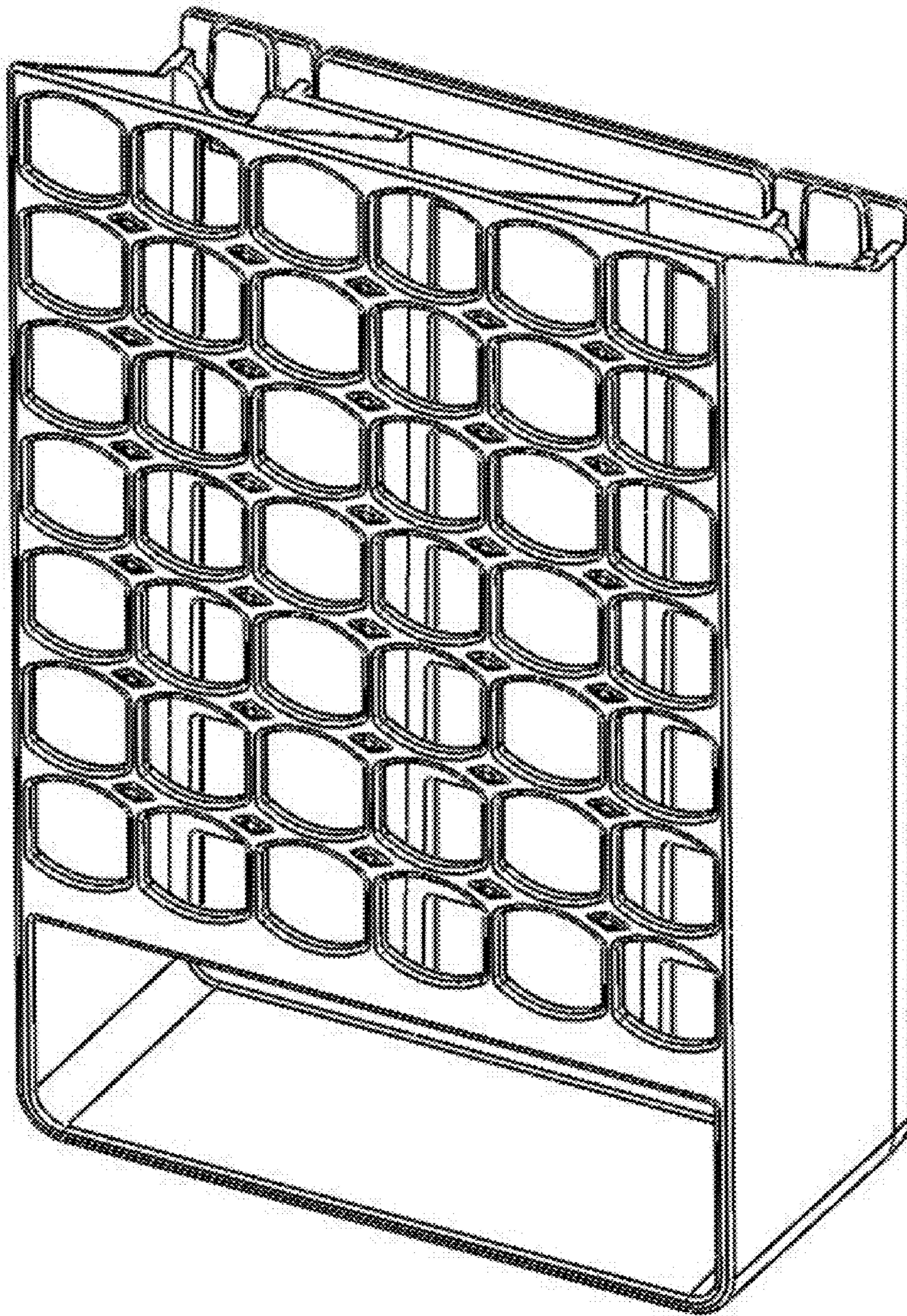

FIG. 15

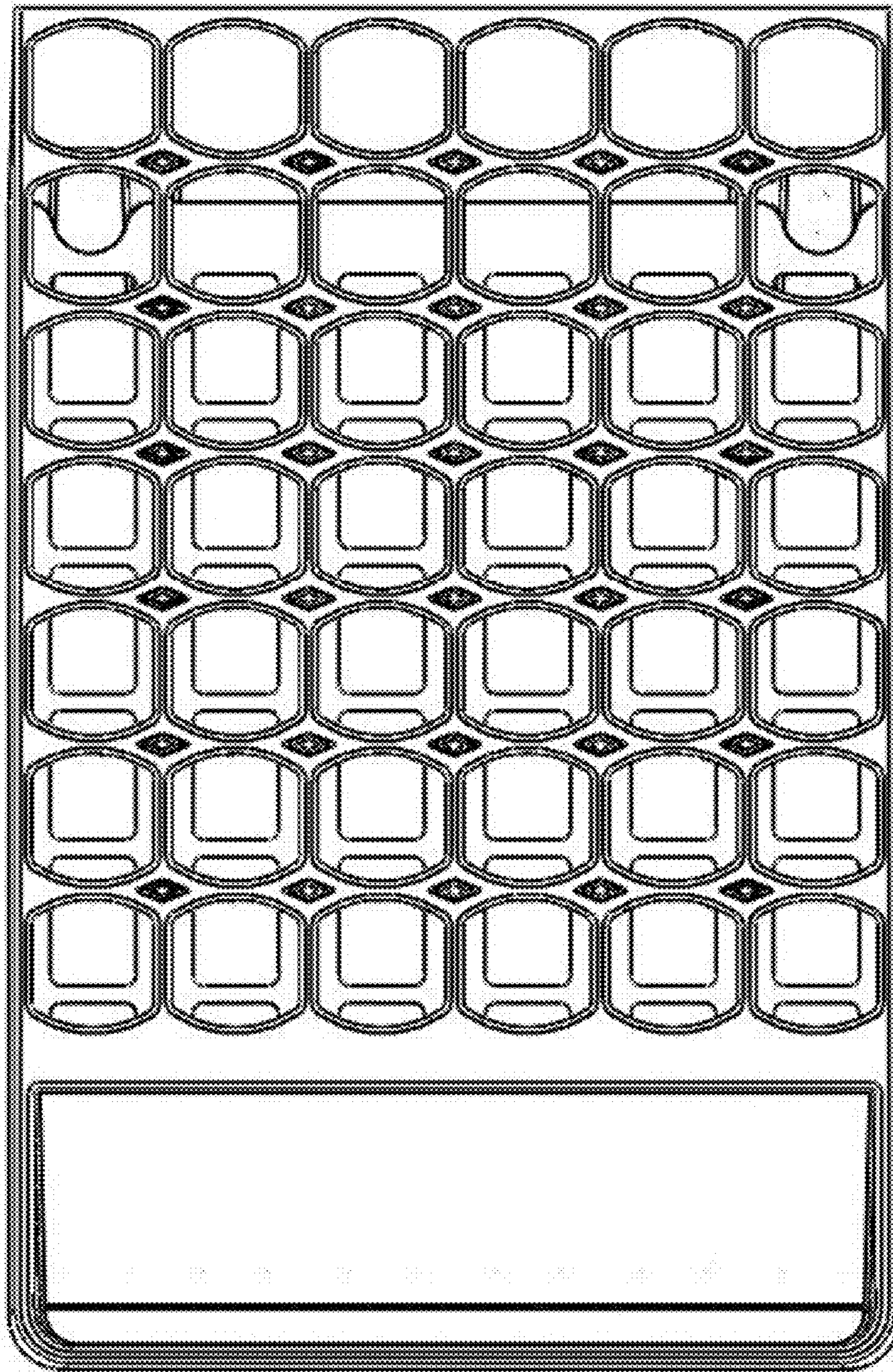

FIG. 16

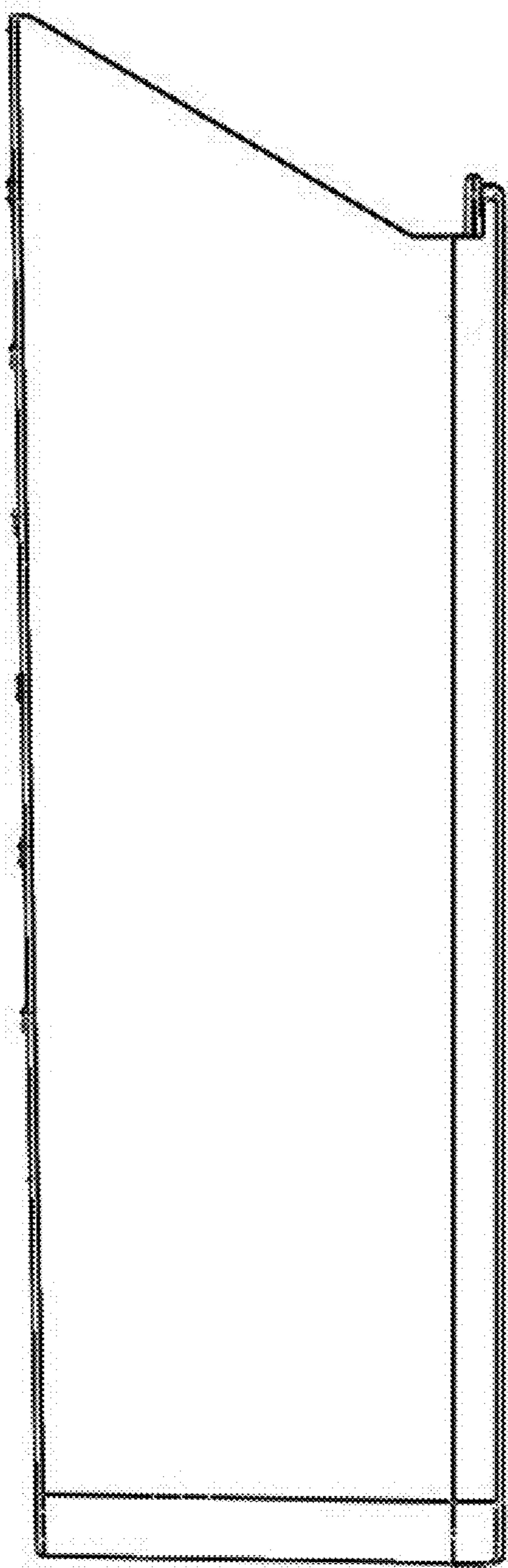

FIG. 17

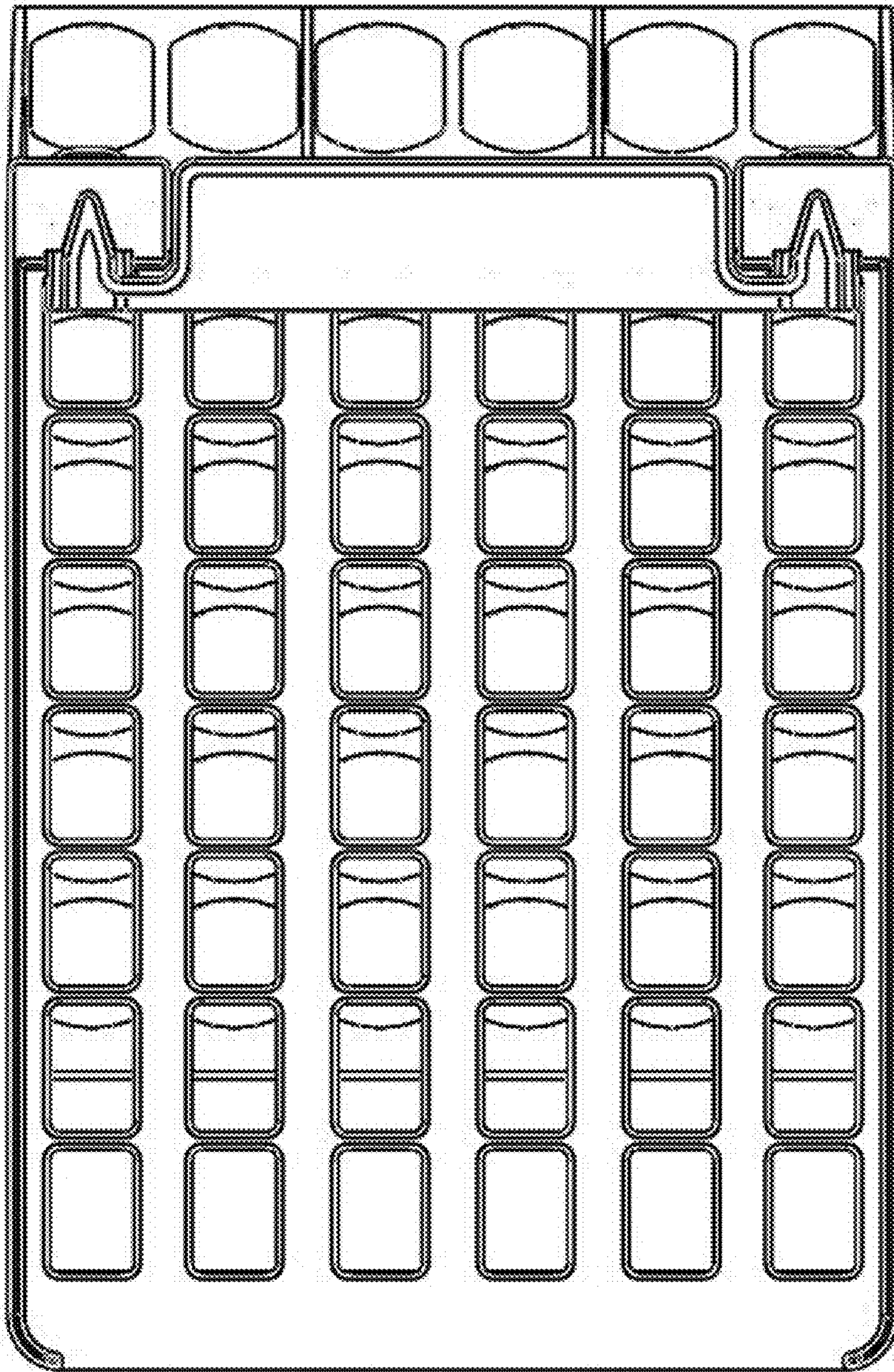

FIG. 18

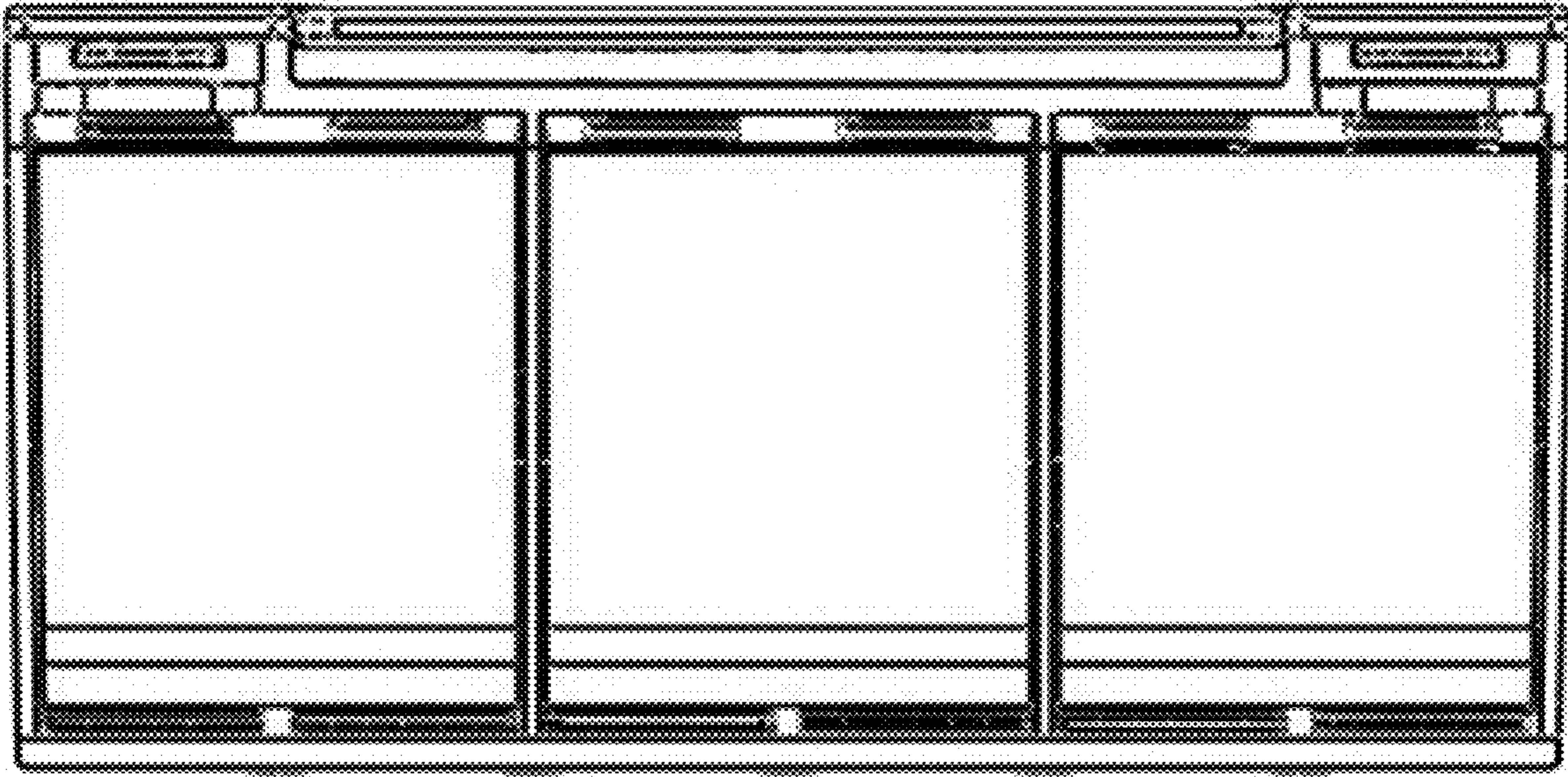

FIG. 19

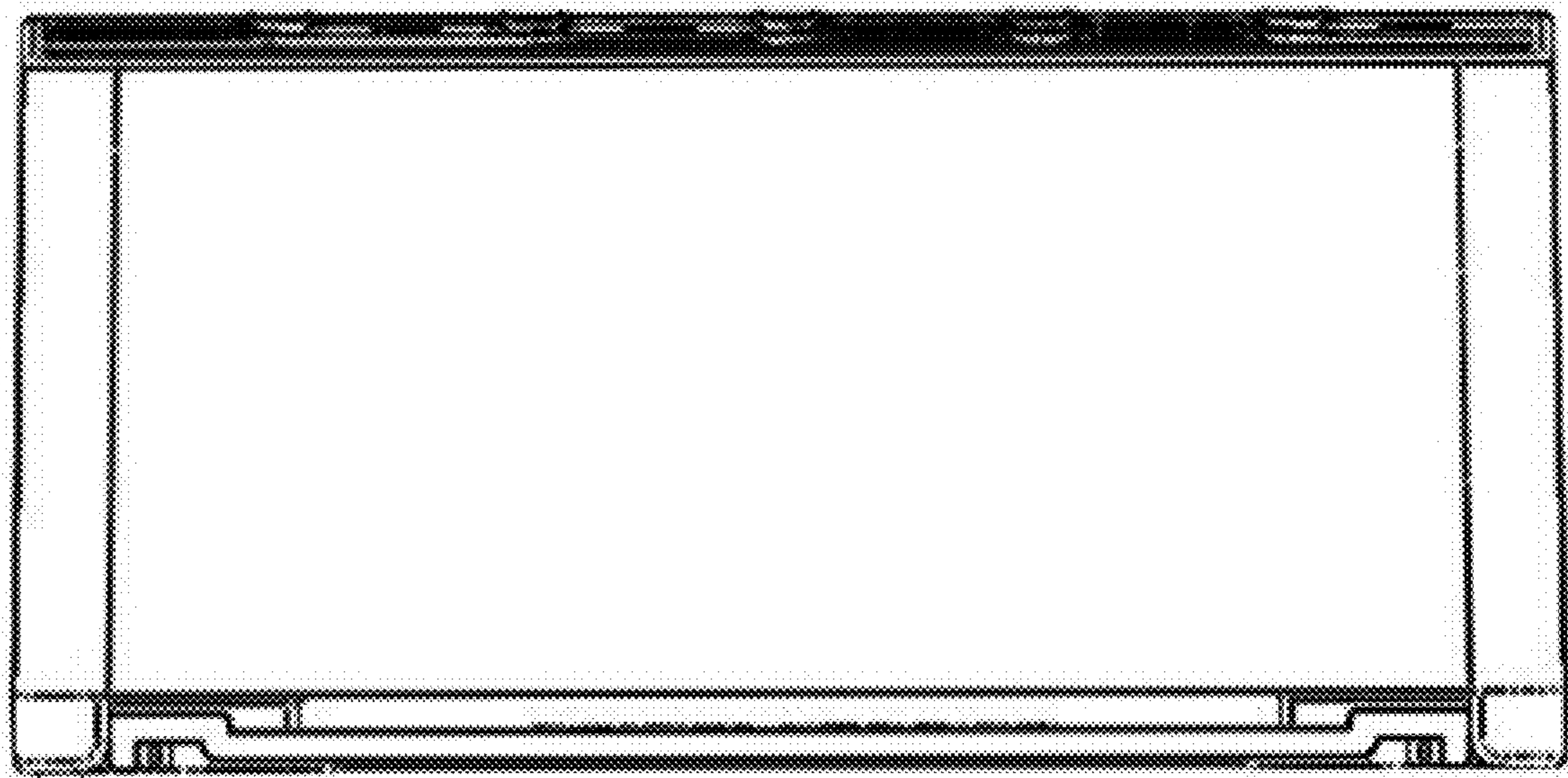

FIG. 20

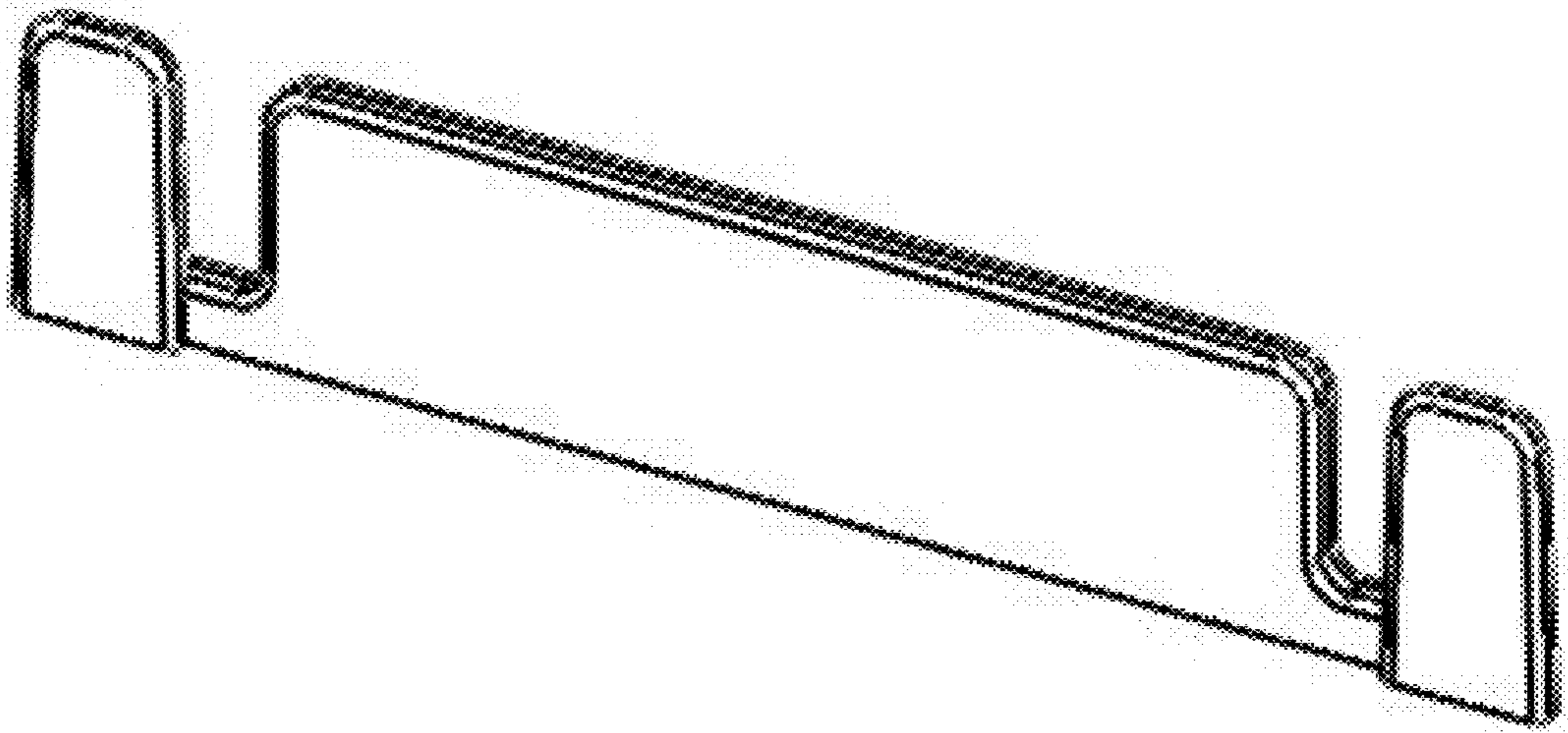

FIG. 21

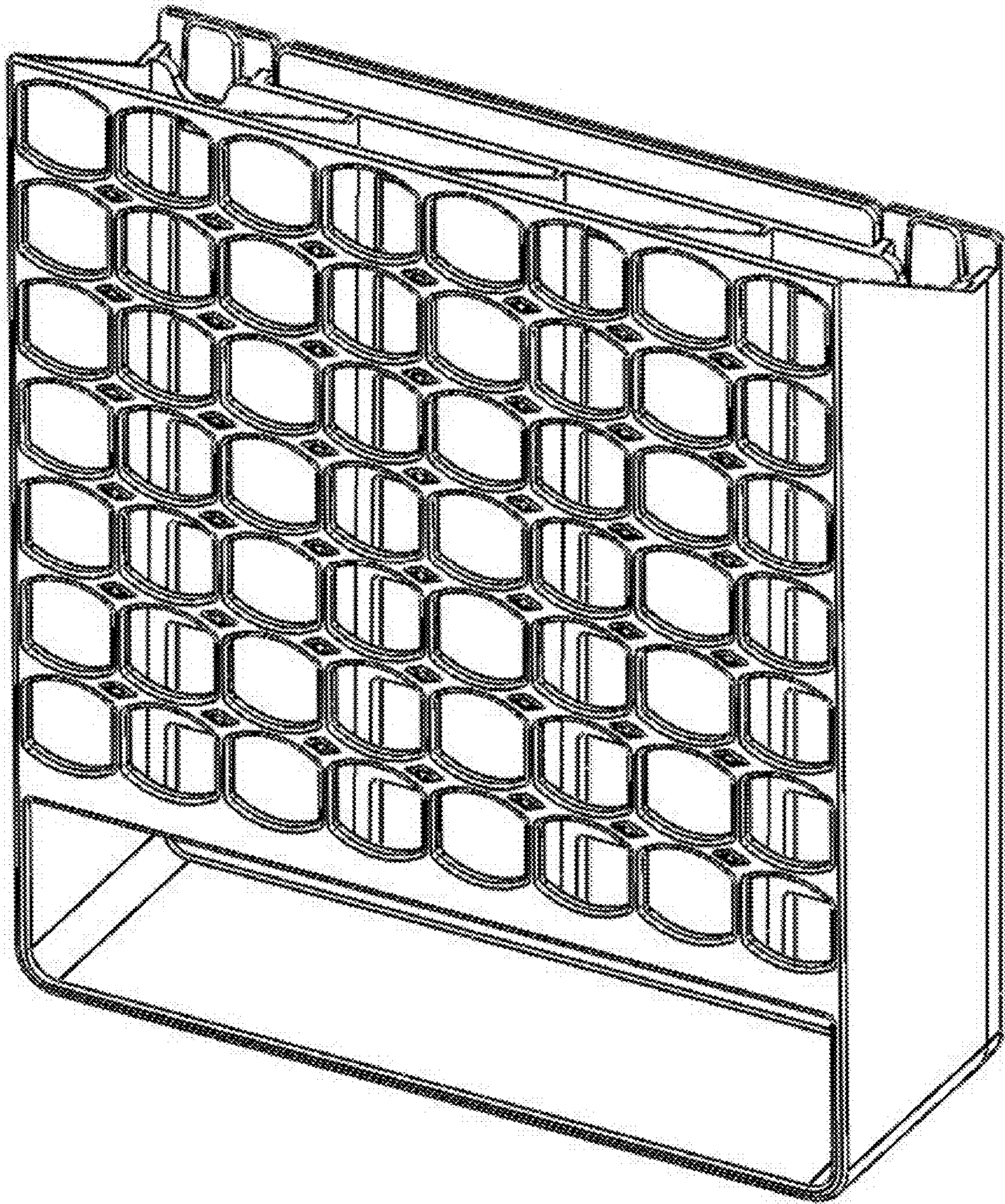

FIG. 22

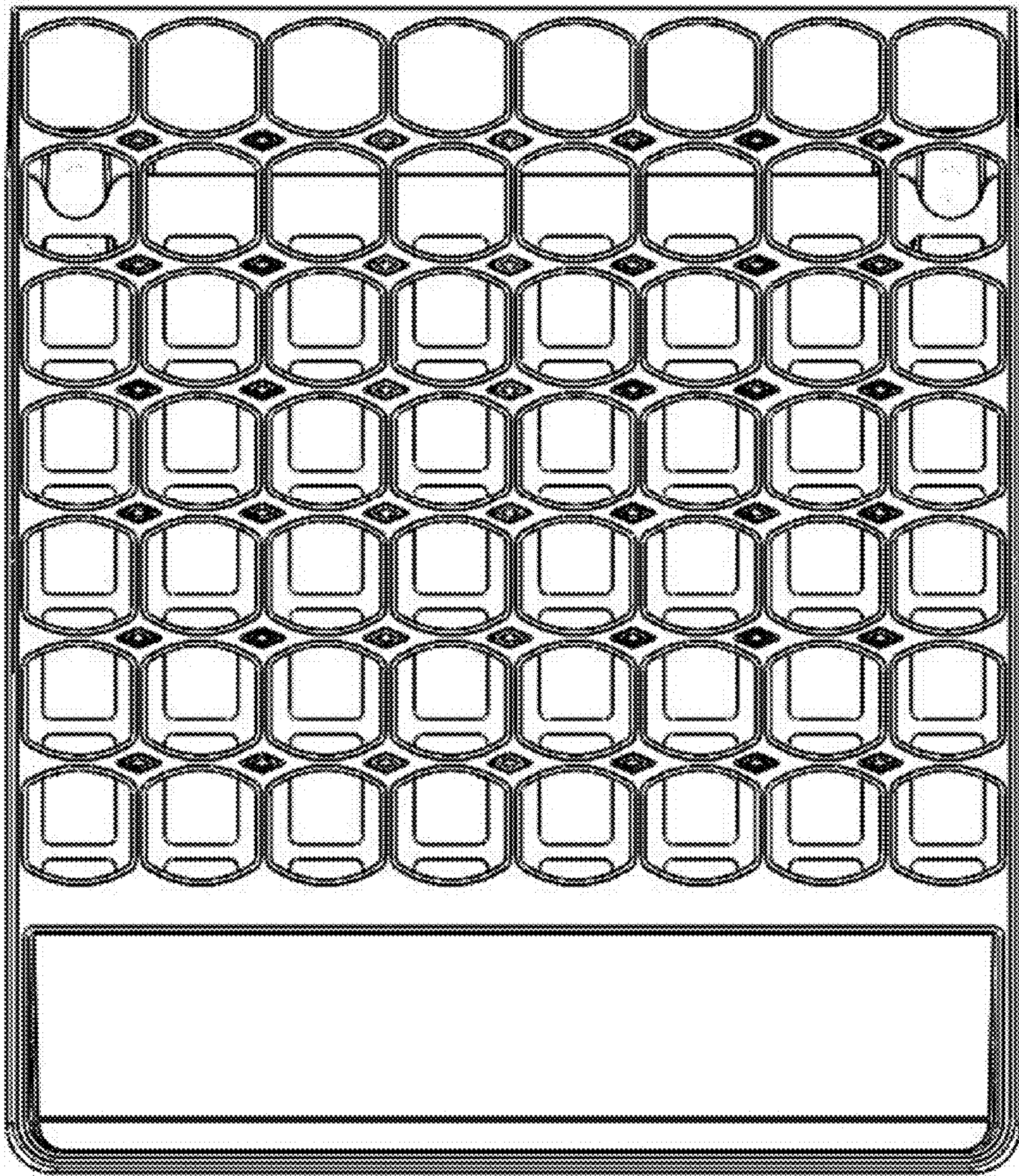

FIG. 23

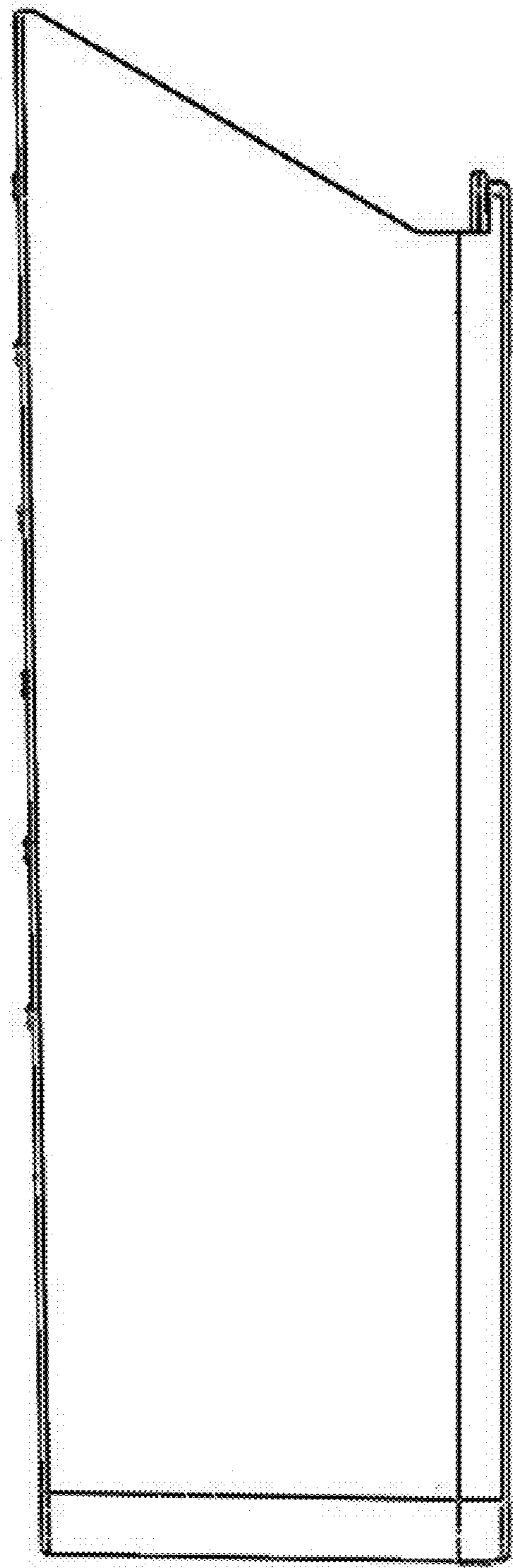

FIG. 24

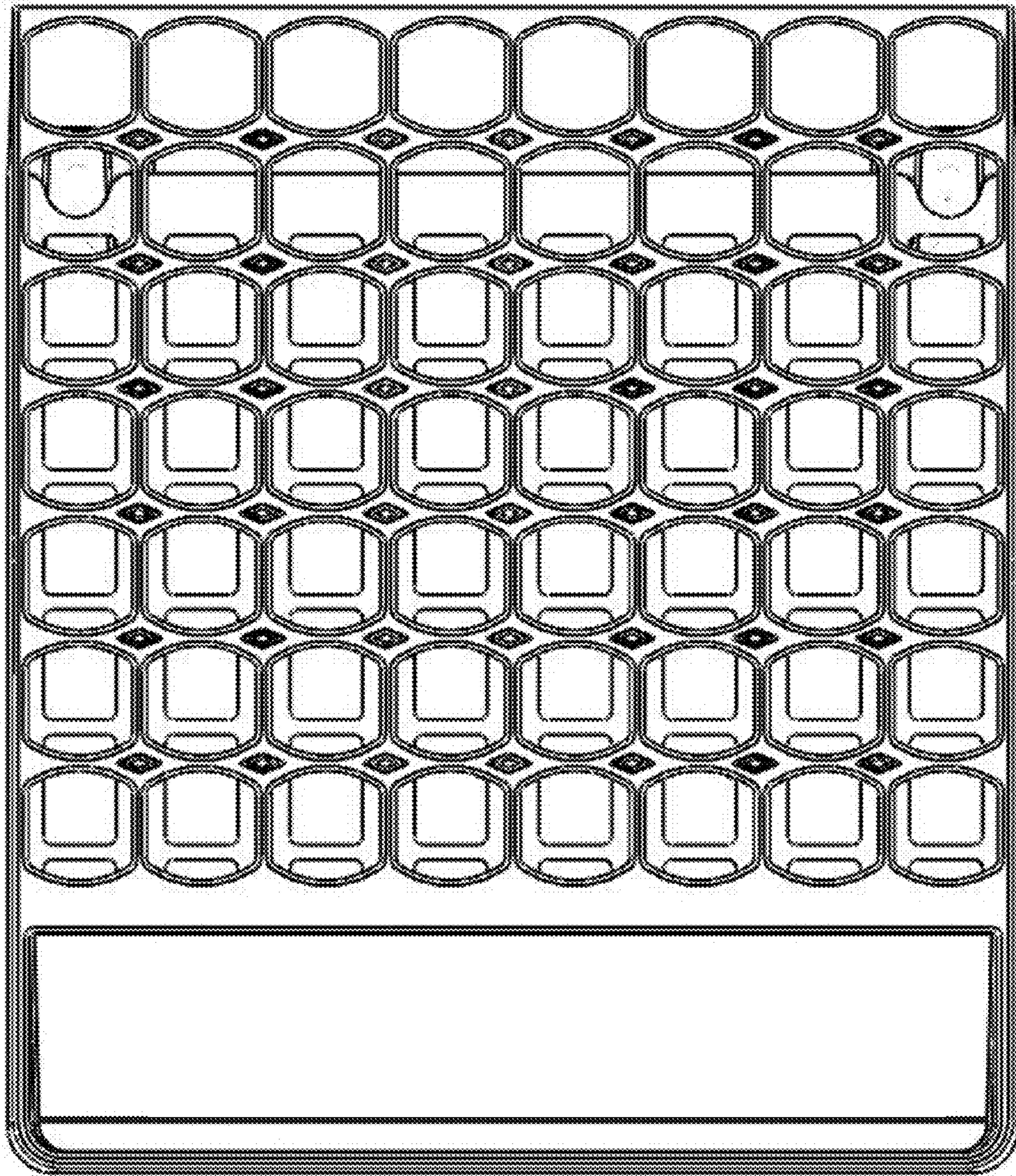

FIG. 25

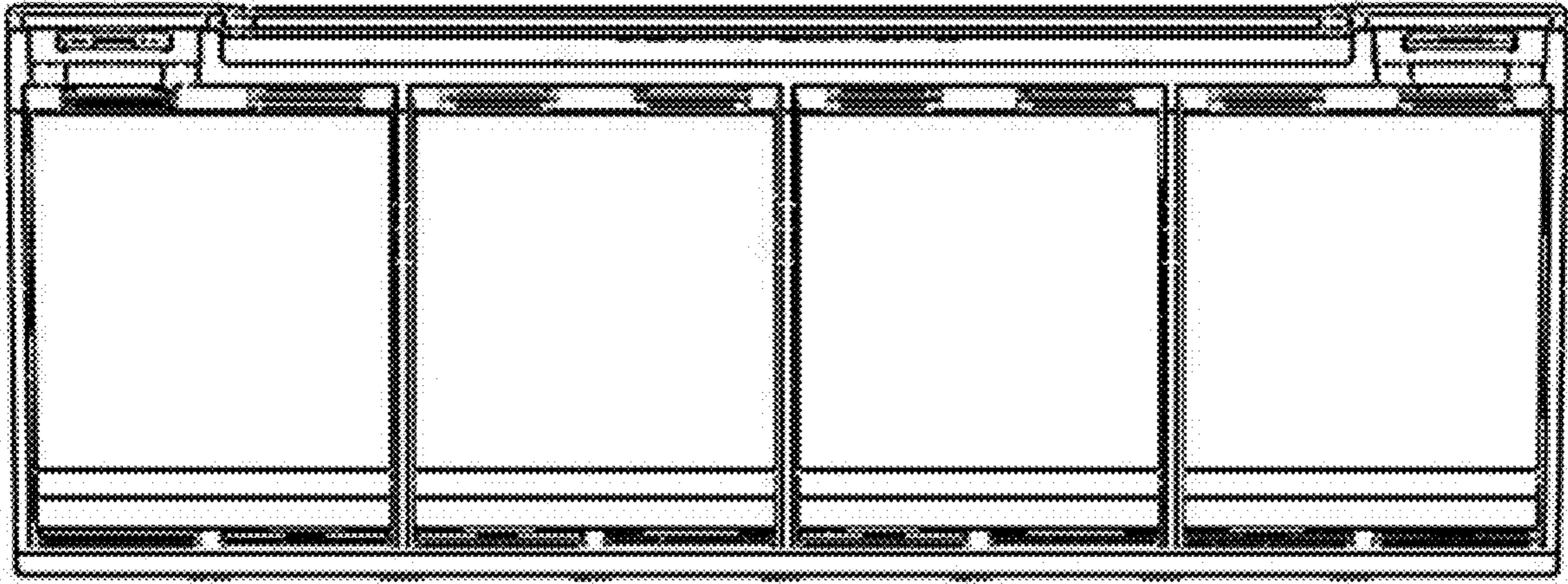

FIG. 26

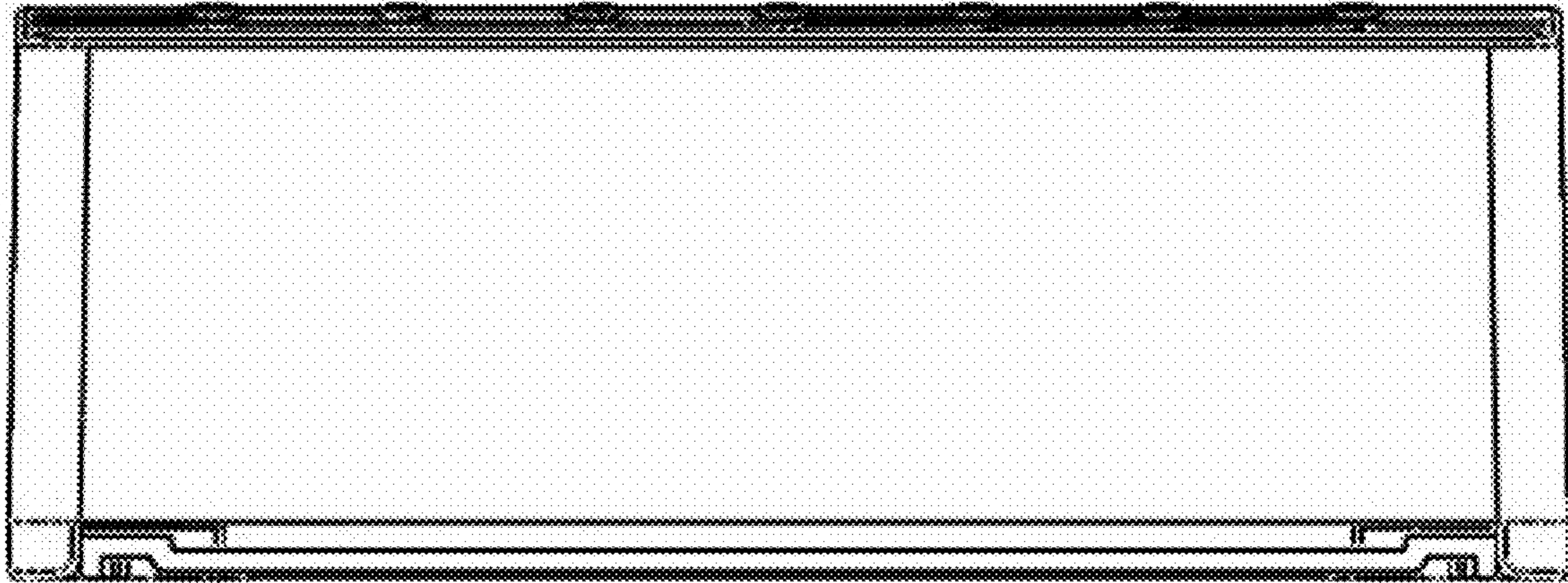

FIG. 27

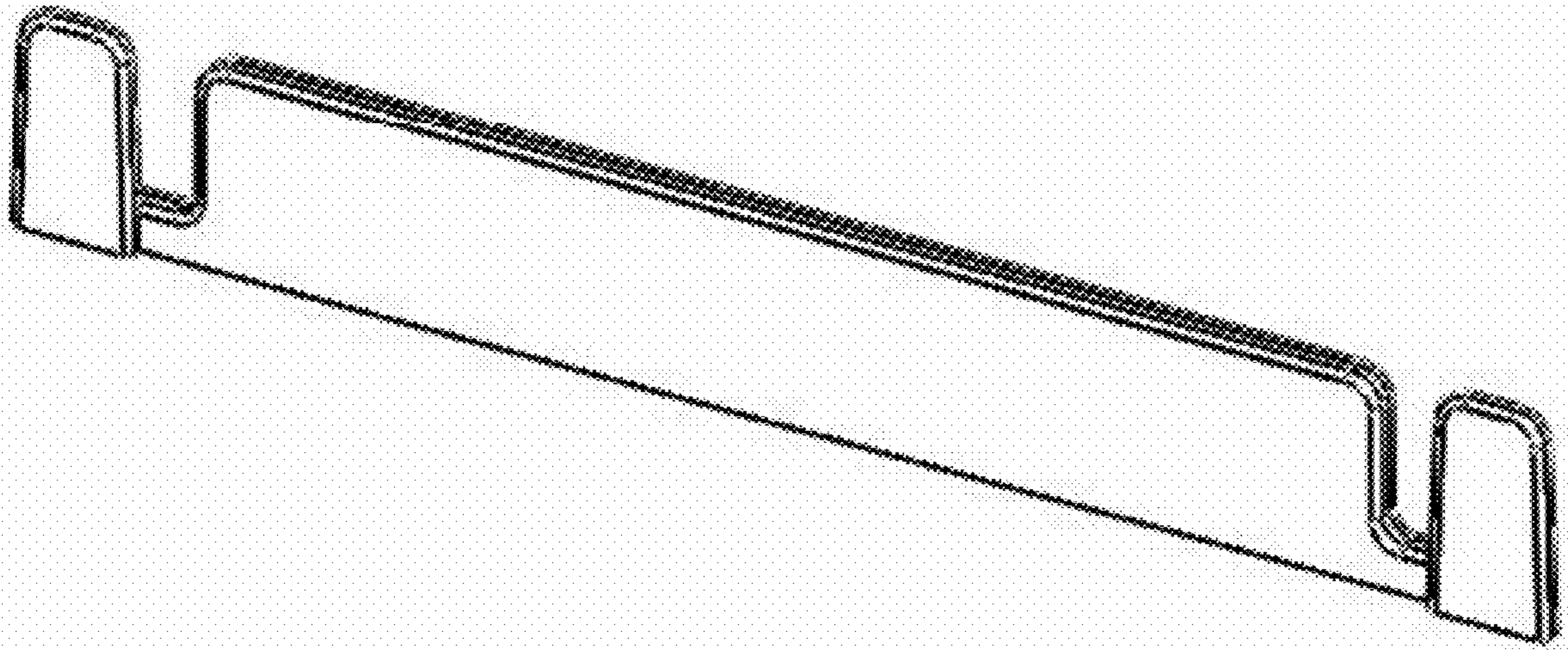

FIG. 28