



US00D634116S

(12) **United States Design Patent**  
**Ebling**

(10) **Patent No.:** **US D634,116 S**  
(45) **Date of Patent:** **\*\* Mar. 15, 2011**

(54) **LOCATOR DEVICE**

(76) **Inventor:** **Dale E. Ebling**, Lake Clarke Shores, FL  
(US)

(\*\*) **Term:** **14 Years**

(21) **Appl. No.:** **29/359,146**

(22) **Filed:** **Apr. 6, 2010**

(51) **LOC (9) Cl.** ..... **03-01**

(52) **U.S. Cl.** ..... **D3/207**

(58) **Field of Classification Search** ..... D11/1-2,  
D11/14, 26-29, 89-92, 44, 48, 81, 99; 63/26-28,  
63/32; D3/207-212; D8/38; 70/456 B;  
206/37.1

See application file for complete search history.

(56) **References Cited**

**U.S. PATENT DOCUMENTS**

|              |        |                 |       |         |
|--------------|--------|-----------------|-------|---------|
| D392,201 S * | 3/1998 | Chen            | ..... | D10/104 |
| 6,366,202 B1 | 4/2002 | Rosenthal       |       |         |
| 6,674,364 B1 | 1/2004 | Holbrook et al. |       |         |
| 6,870,483 B1 | 3/2005 | Davis           |       |         |

|                 |         |                 |       |        |
|-----------------|---------|-----------------|-------|--------|
| 7,230,533 B2    | 6/2007  | Hamolsky        |       |        |
| D577,485 S *    | 9/2008  | Mohs            | ..... | D3/207 |
| D603,601 S *    | 11/2009 | Ohta et al.     | ..... | D3/207 |
| 2007/0129113 A1 | 6/2007  | Klicpera et al. |       |        |

\* cited by examiner

*Primary Examiner* — Ralf Seifert

(74) *Attorney, Agent, or Firm* — Crossley Patent Law; Mark A. Crossley

(57) **CLAIM**

The ornamental design for a locator device, as shown and described.

**DESCRIPTION**

FIG. 1 is a front elevation view of a Locator Device showing my new design;

FIG. 2 is a rear elevation view thereof;

FIG. 3 is a right elevation view thereof;

FIG. 4 is a left elevation view thereof;

FIG. 5 is a top plan view thereof;

FIG. 6 is a bottom plan view thereof; and,

FIG. 7 is an isometric view thereof.

**1 Claim, 5 Drawing Sheets**

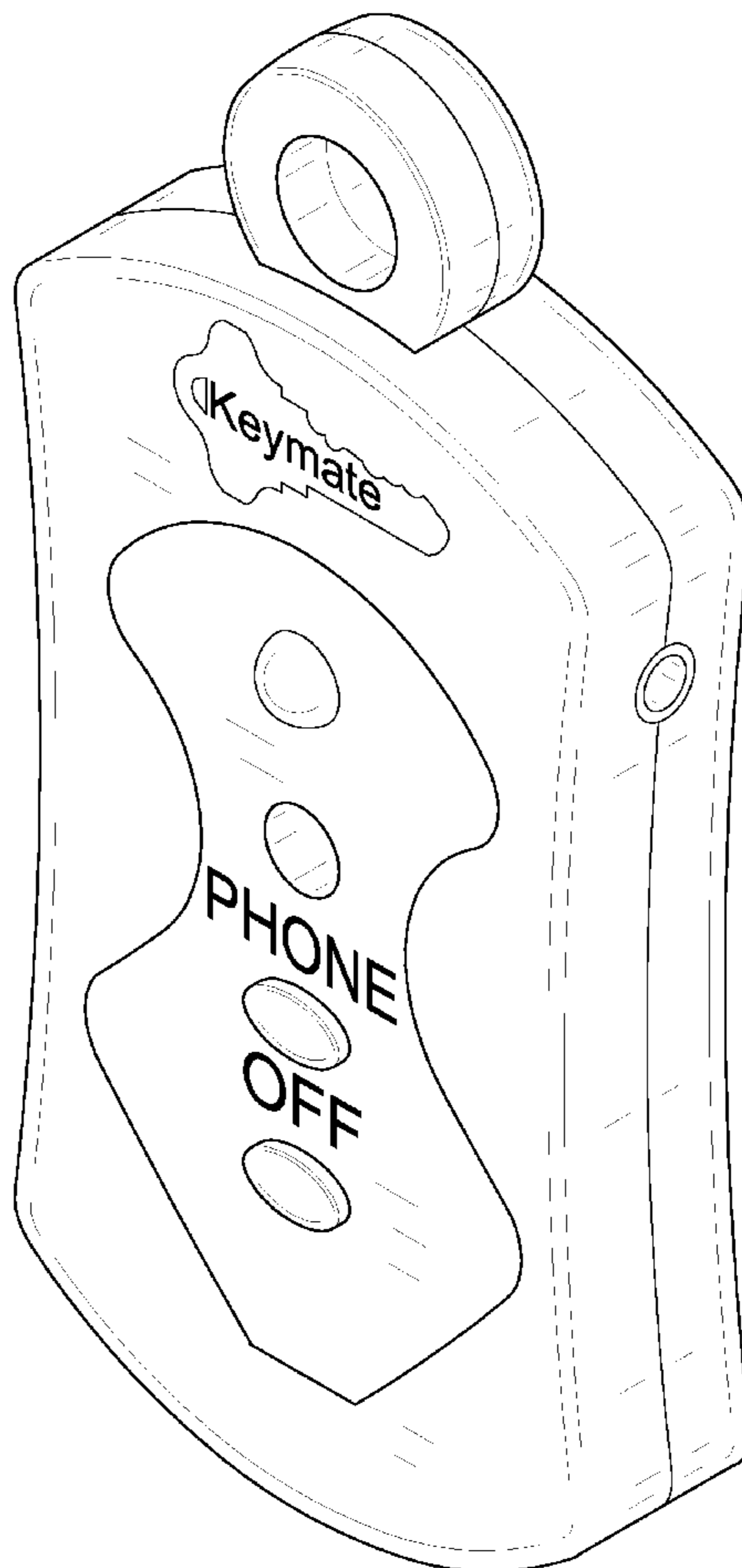

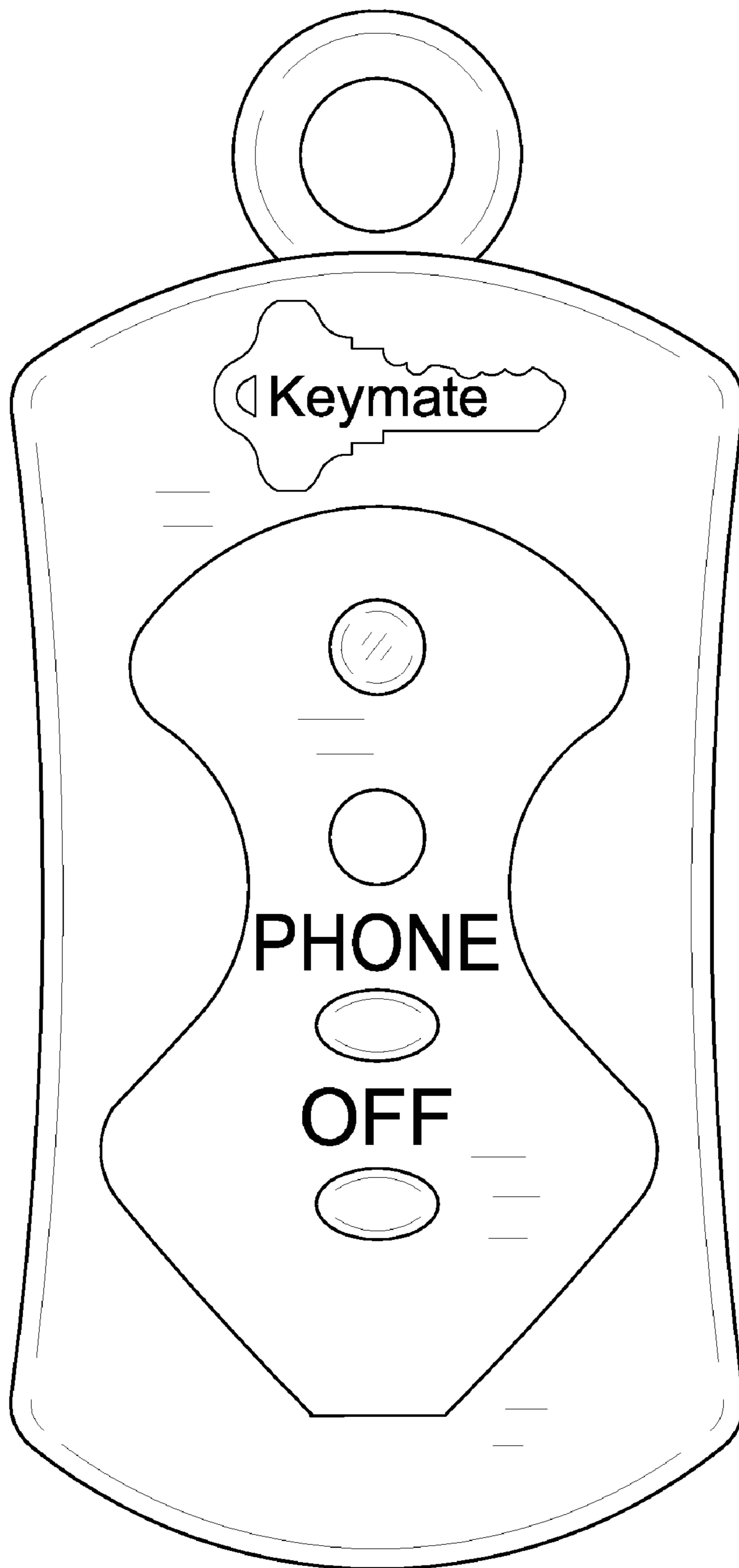

FIG. 1

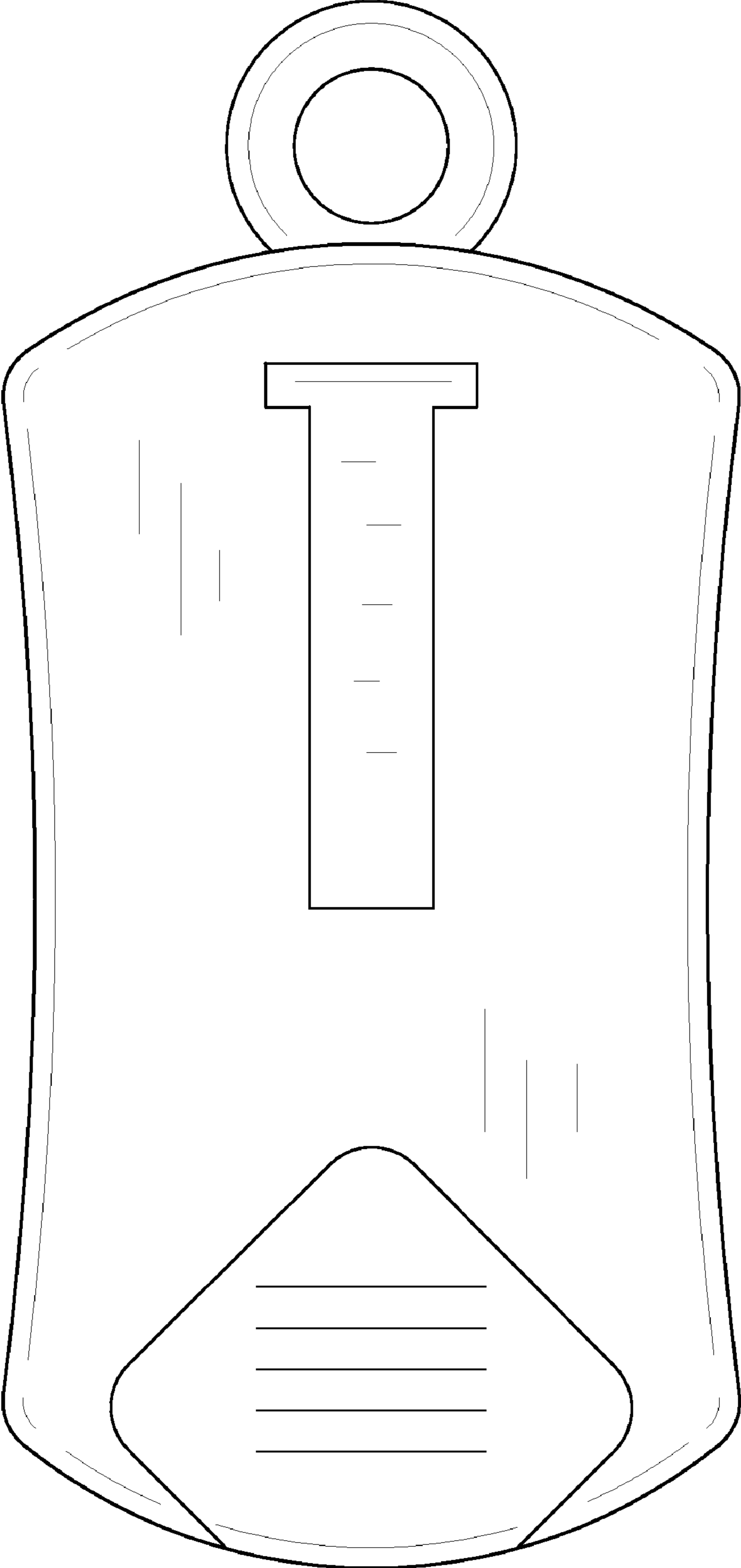

FIG. 2

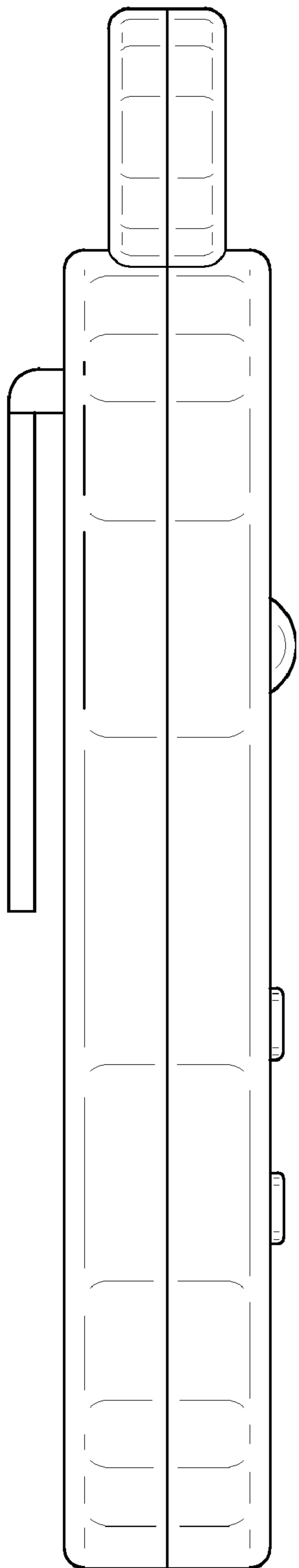

FIG. 3

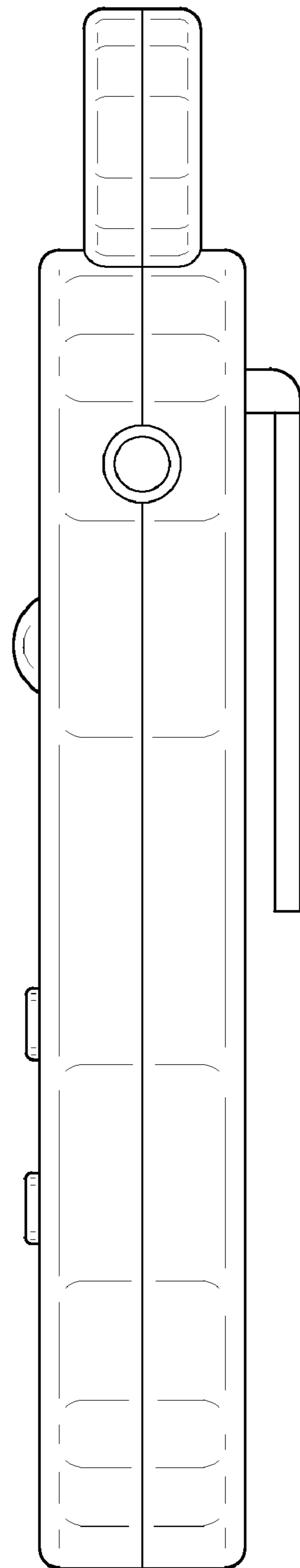

FIG. 4

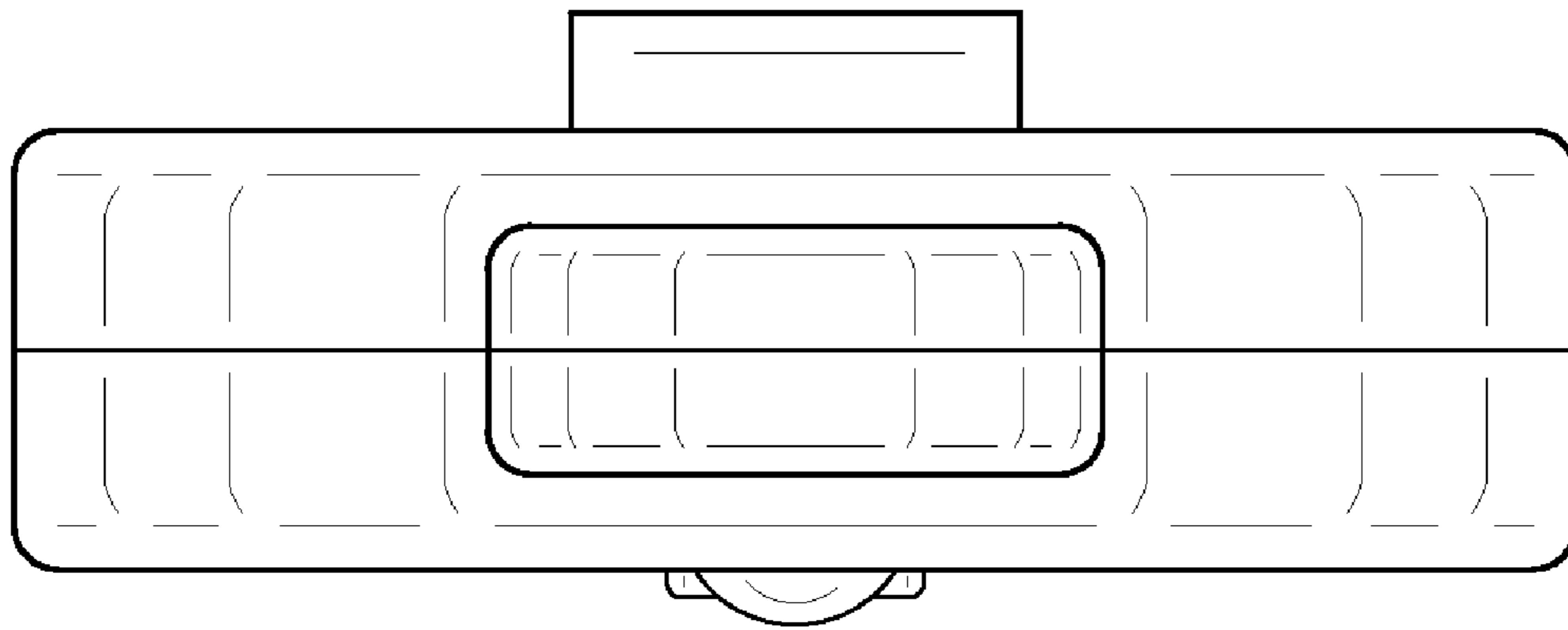

FIG. 5

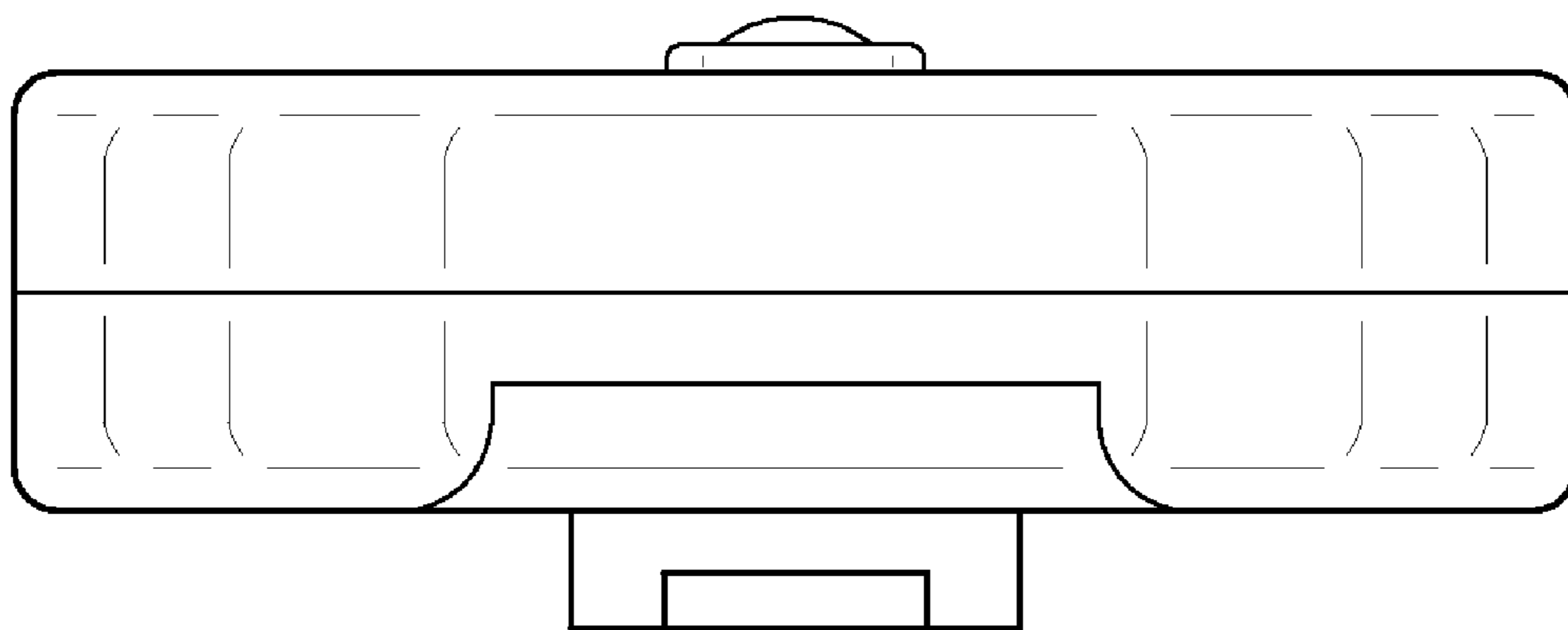

FIG. 6

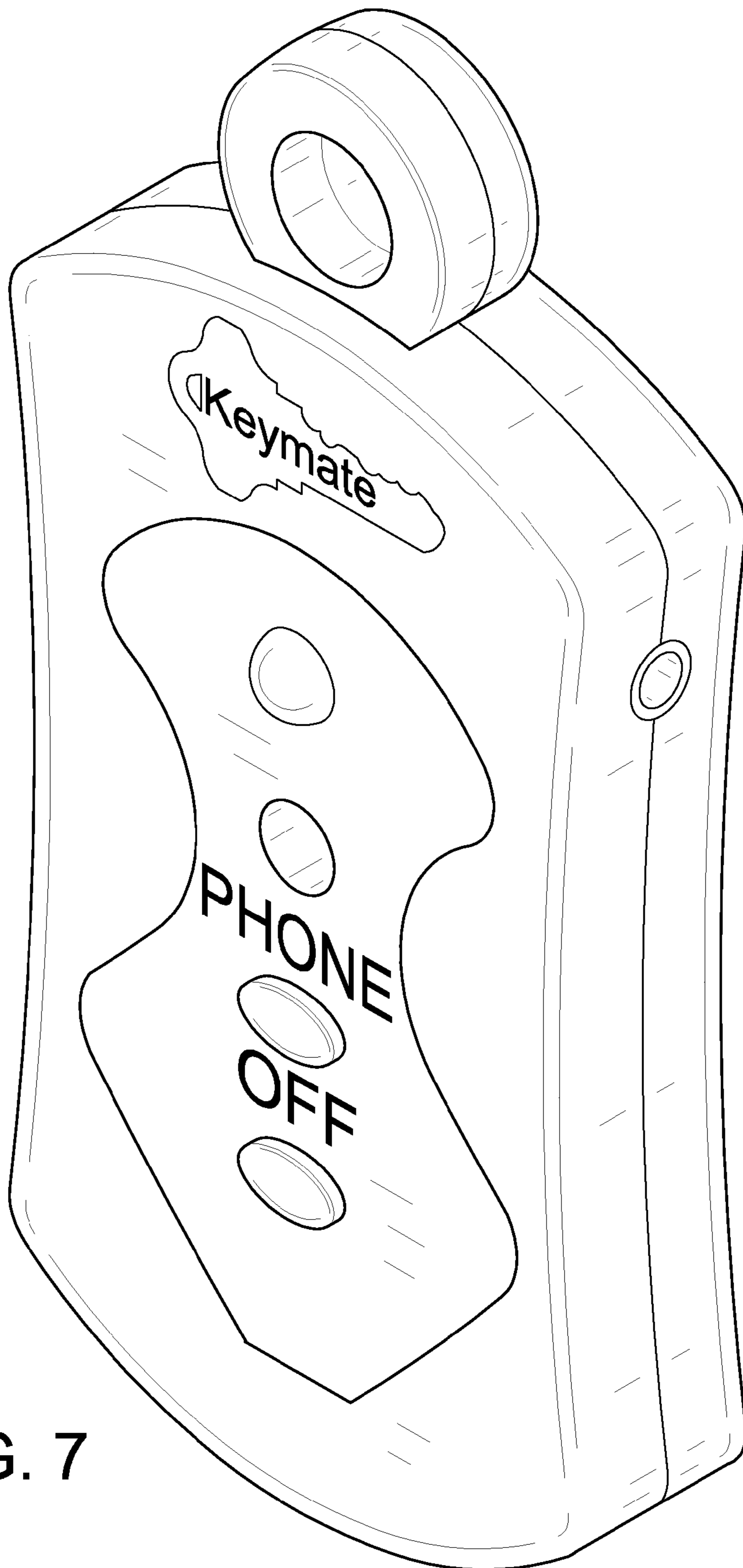

FIG. 7