



US00D634110S

(12) **United States Design Patent**  
**MacIntyre**

(10) **Patent No.:** **US D634,110 S**  
(45) **Date of Patent:** **\*\* Mar. 15, 2011**

(54) **FOOTWEAR UPPER**

(75) Inventor: **Jennifer MacIntyre**, Santa Barbara, CA  
(US)

(73) Assignee: **Deckers Outdoor Corporation**, Goleta,  
CA (US)

(\*\*) Term: **14 Years**

(21) Appl. No.: **29/350,089**

(22) Filed: **Nov. 11, 2009**

(51) **LOC (9) Cl.** ..... **02-99**

(52) **U.S. Cl.** ..... **D2/970; D2/912**

(58) **Field of Classification Search** ..... D2/896,  
D2/900, 909-911, 920, 943, 946, 969, 970,  
D2/974; 36/83, 1.5, 2 R, 109, 3 A, 7.1 R,  
36/45, 52, 112, 100

See application file for complete search history.

D243,567 S 3/1977 De Massacre  
D282,119 S \* 1/1986 Kamali ..... D2/912  
D314,272 S 2/1991 Laycock  
D331,826 S \* 12/1992 Challant ..... D2/911  
D551,829 S \* 10/2007 McLin ..... D2/912  
D581,647 S \* 12/2008 St-Louis ..... D2/970  
D583,133 S \* 12/2008 Winjum ..... D2/912

**FOREIGN PATENT DOCUMENTS**

EM 000487665-0002 2/2006  
EM 000533823-0013 5/2006

\* cited by examiner

*Primary Examiner* — Robert M Spear

*Assistant Examiner* — Rashida C McCoy

(74) *Attorney, Agent, or Firm* — Greer, Burns & Crain, Ltd.

(57) **CLAIM**

The ornamental design for a footwear upper, as shown and described.

(56) **References Cited**

**U.S. PATENT DOCUMENTS**

D10,384 S 12/1877 Pienovi  
D23,234 S 5/1894 Nathan  
D34,733 S \* 7/1901 Maguire ..... D2/912  
D42,379 S 4/1912 Bernstein  
1,538,104 A 3/1923 Foster  
1,542,499 A 6/1925 Gargan  
D71,452 S 11/1926 Bott et al.  
D164,155 S \* 8/1951 Bingham ..... D2/912  
D164,667 S \* 10/1951 Bingham ..... D2/912  
D199,558 S \* 11/1964 Cohn ..... D2/912  
D204,658 S \* 5/1966 Wakeland ..... D2/912  
D234,929 S \* 4/1975 Schneider ..... D2/912  
D238,911 S 2/1976 Persson  
D240,972 S \* 8/1976 Adam ..... D2/912  
D243,483 S 3/1977 Pietraszek et al.

**DESCRIPTION**

FIG. 1 is a perspective view of a footwear upper showing my new design;

FIG. 2 is a side elevational view thereof;

FIG. 3 is an opposite side elevational view thereof;

FIG. 4 is a front elevational view thereof;

FIG. 5 is a rear elevational view thereof;

FIG. 6 is a top plan view thereof; and,

FIG. 7 is a bottom plan view thereof.

The broken lines in FIGS. 1-7 represent portions of the footwear that form no part of the claimed design. The broken lines which define the bounds of the claimed design forms no part thereof.

**1 Claim, 5 Drawing Sheets**

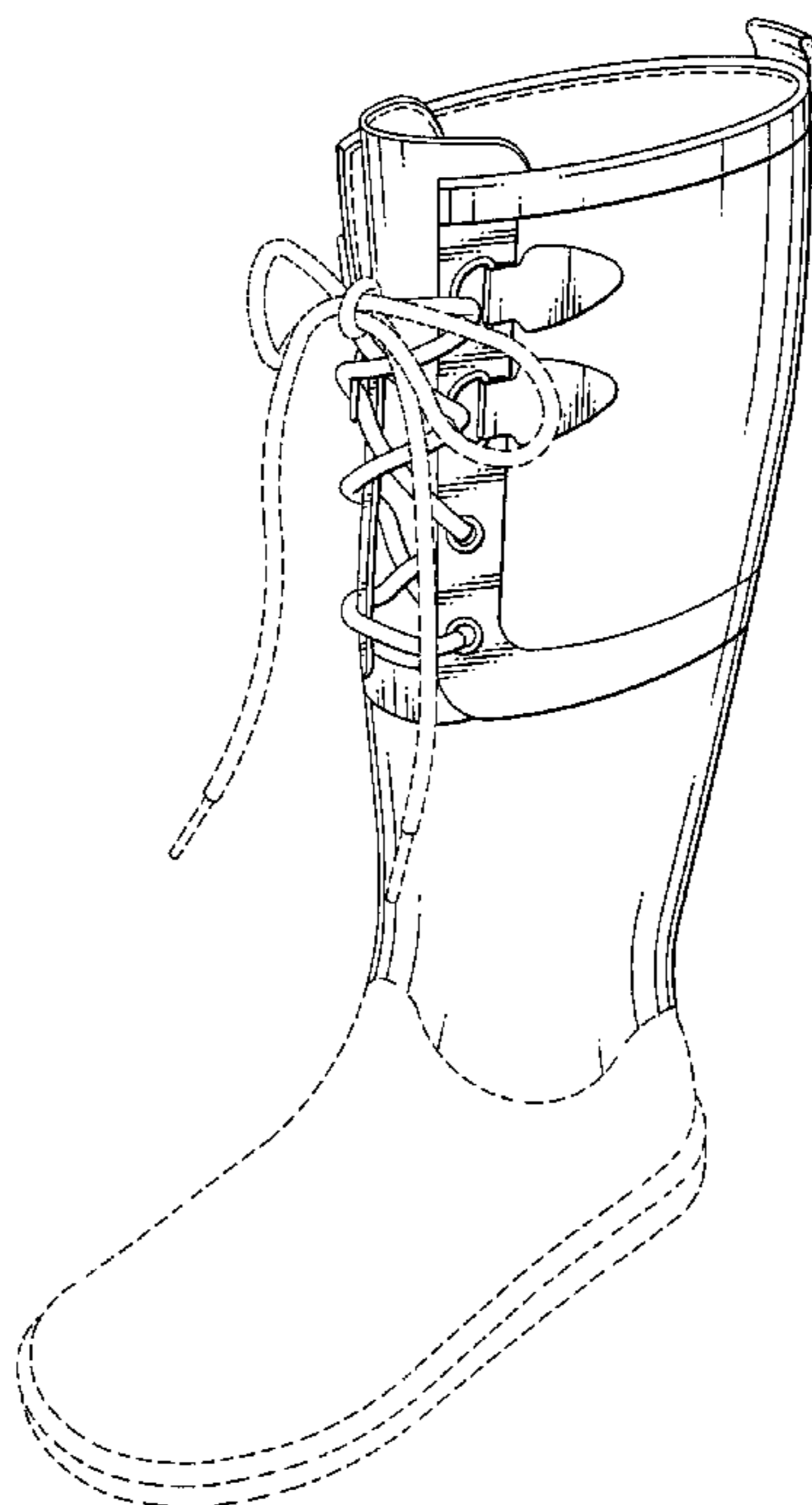

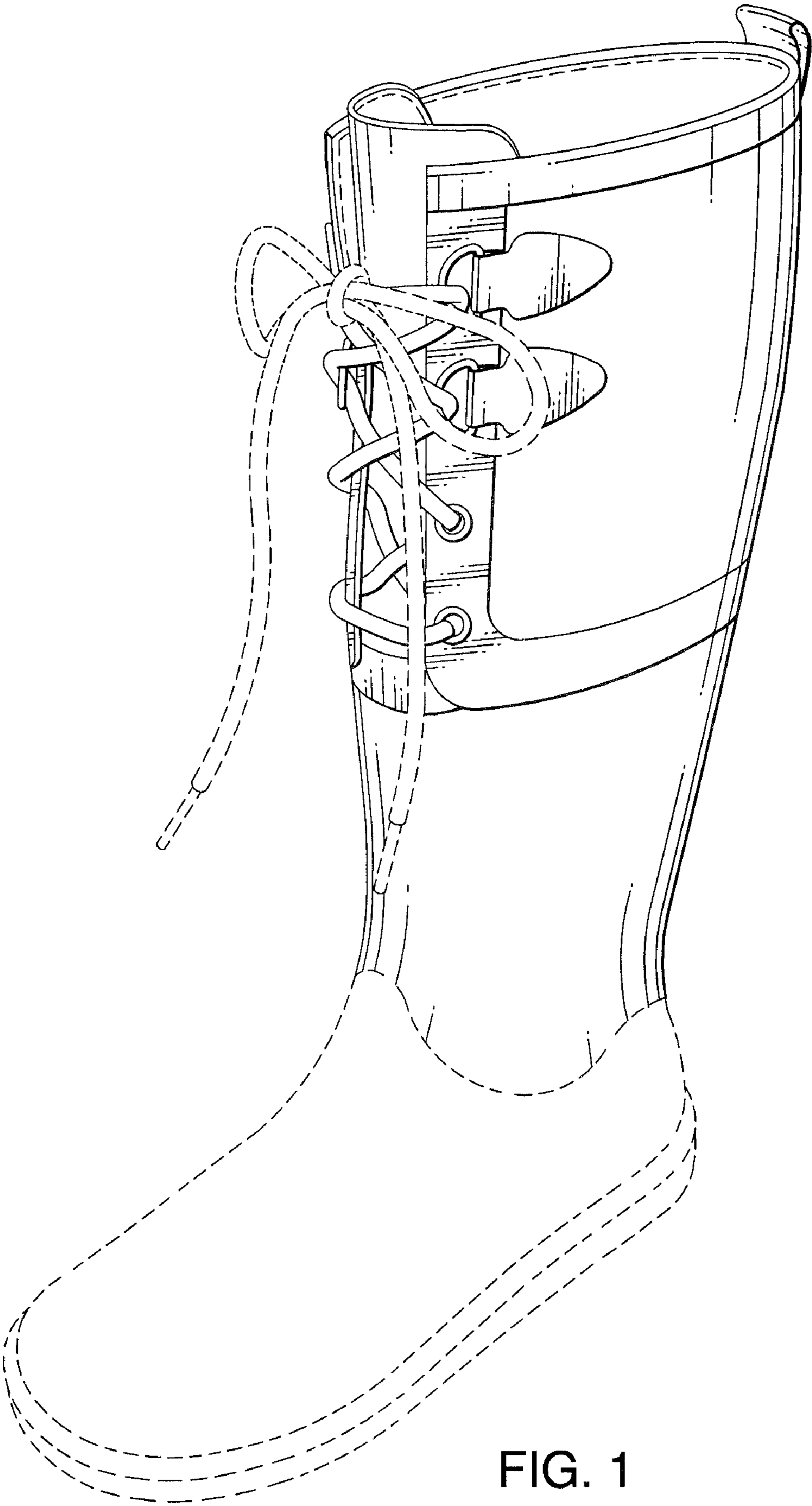

FIG. 1

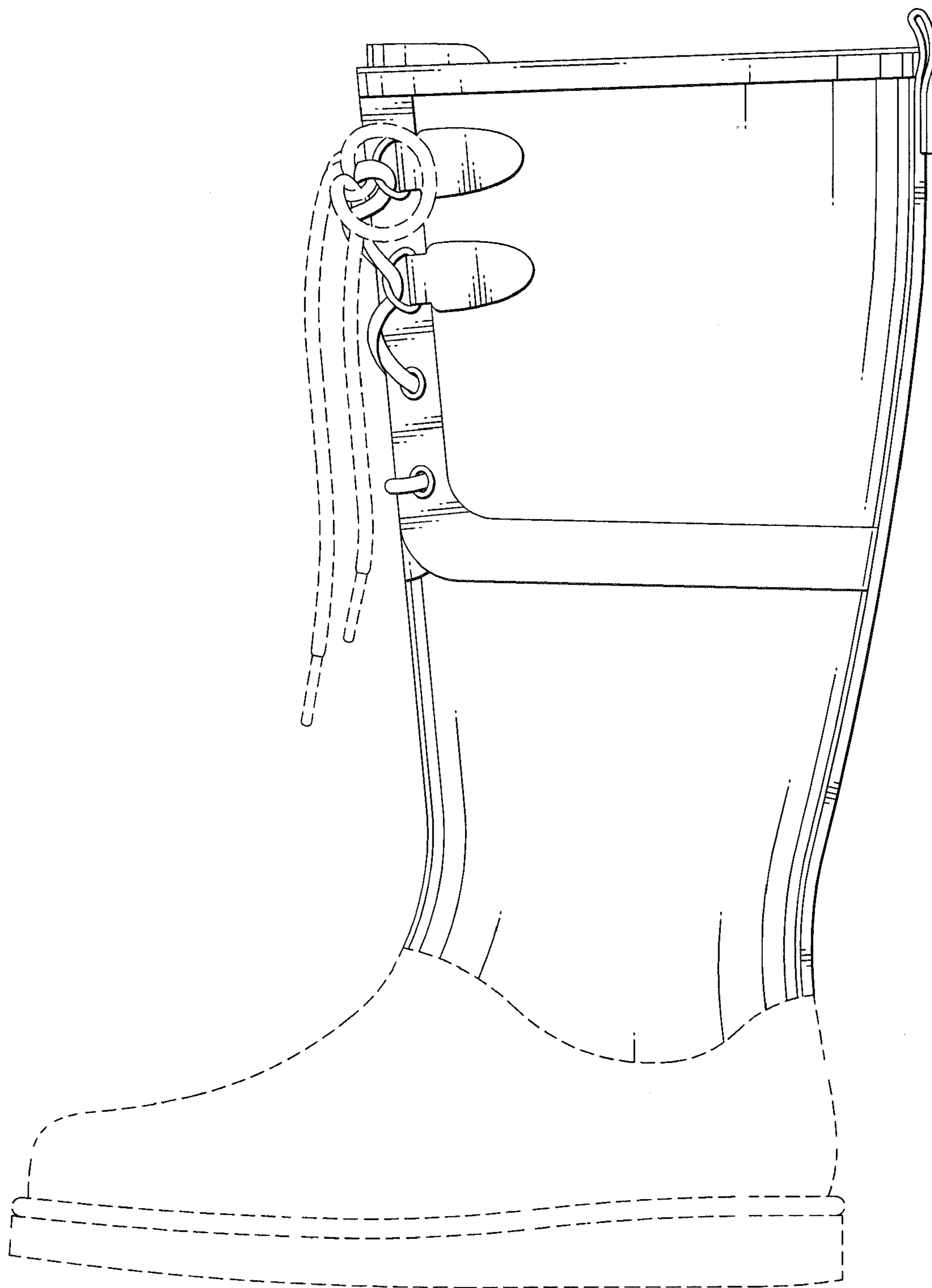

FIG. 2

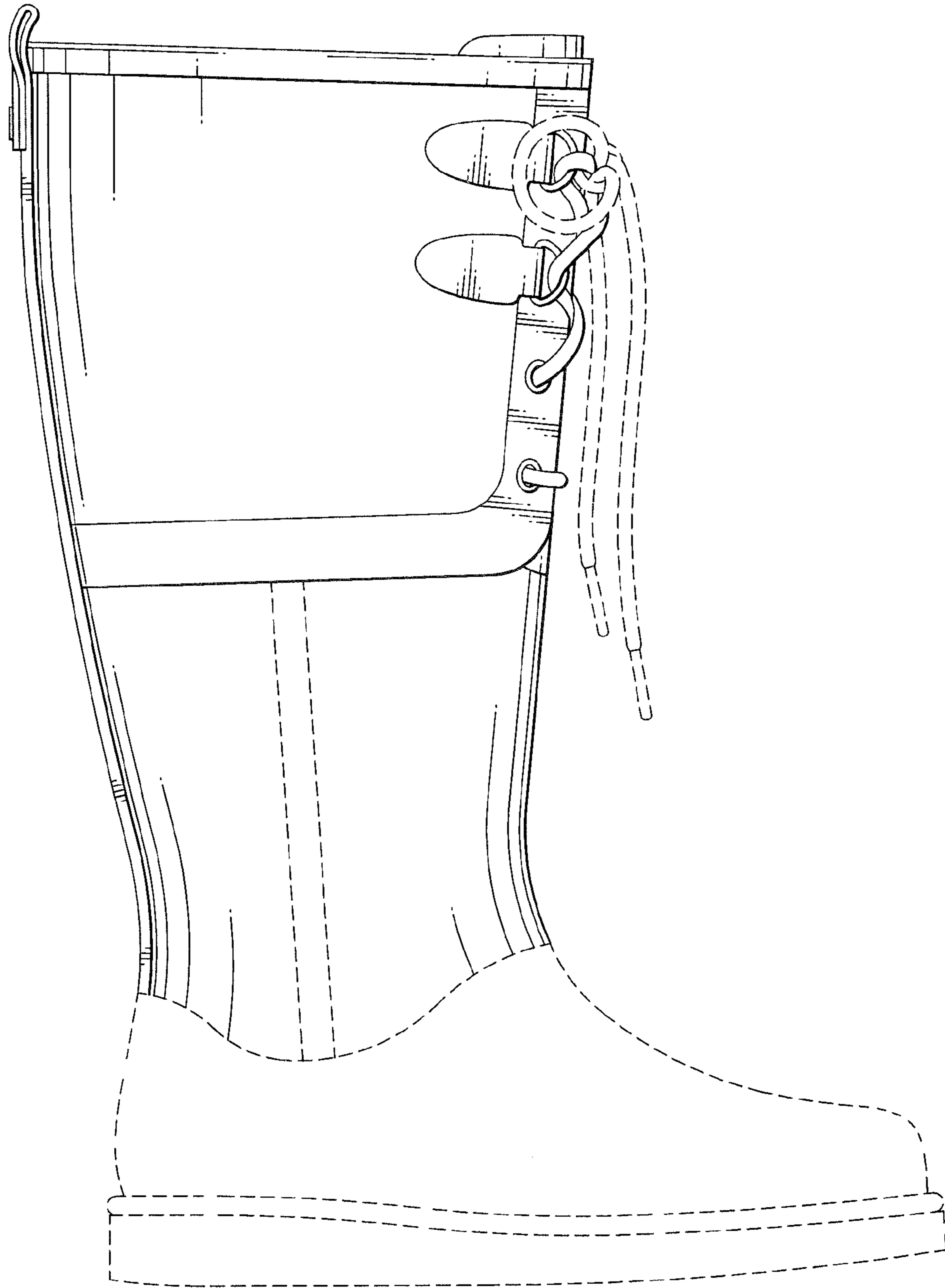

FIG. 3

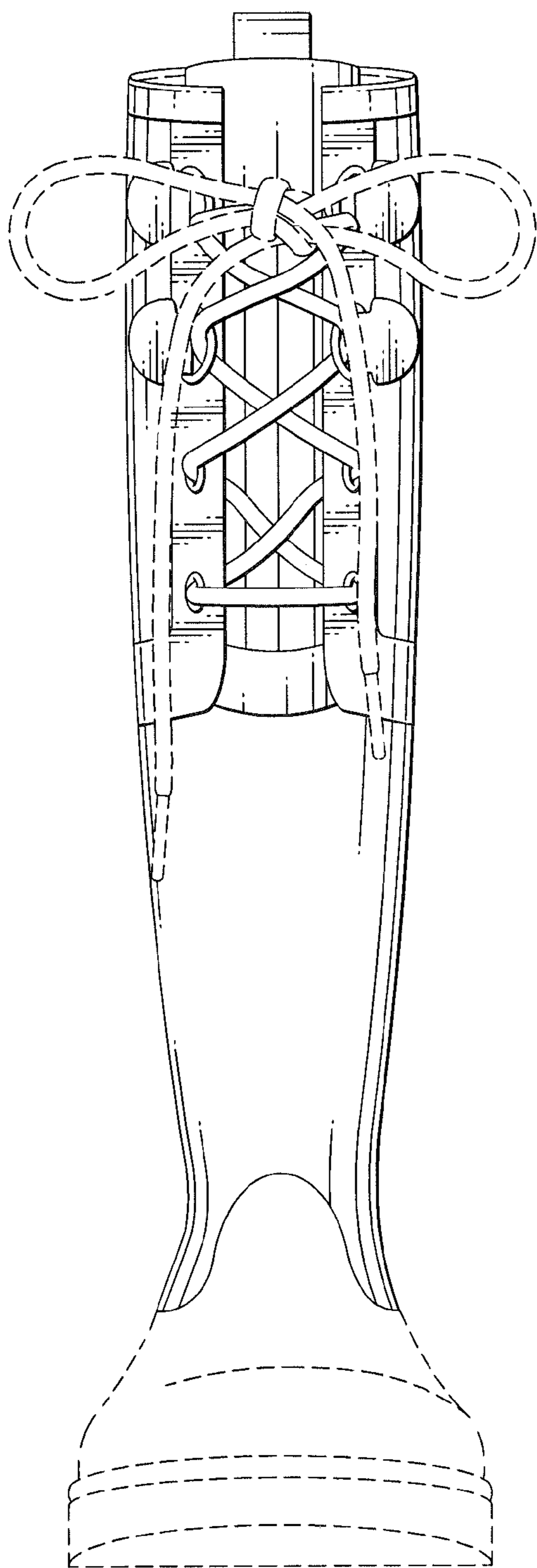

FIG. 4

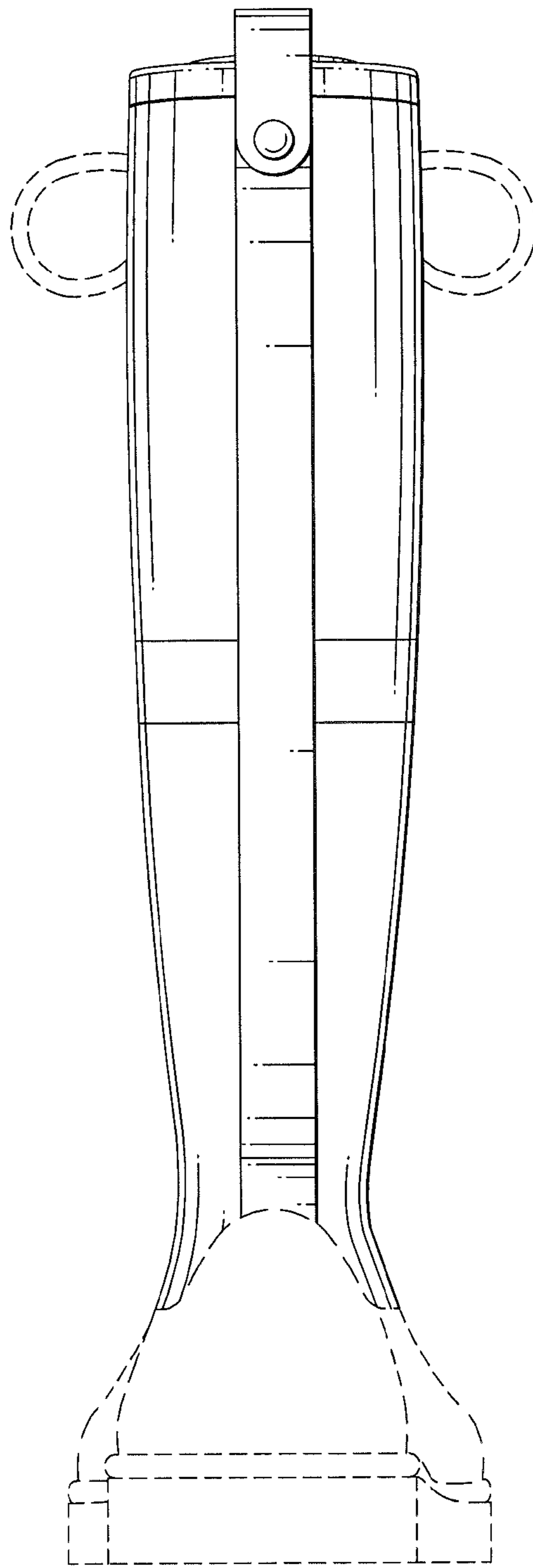

FIG. 5

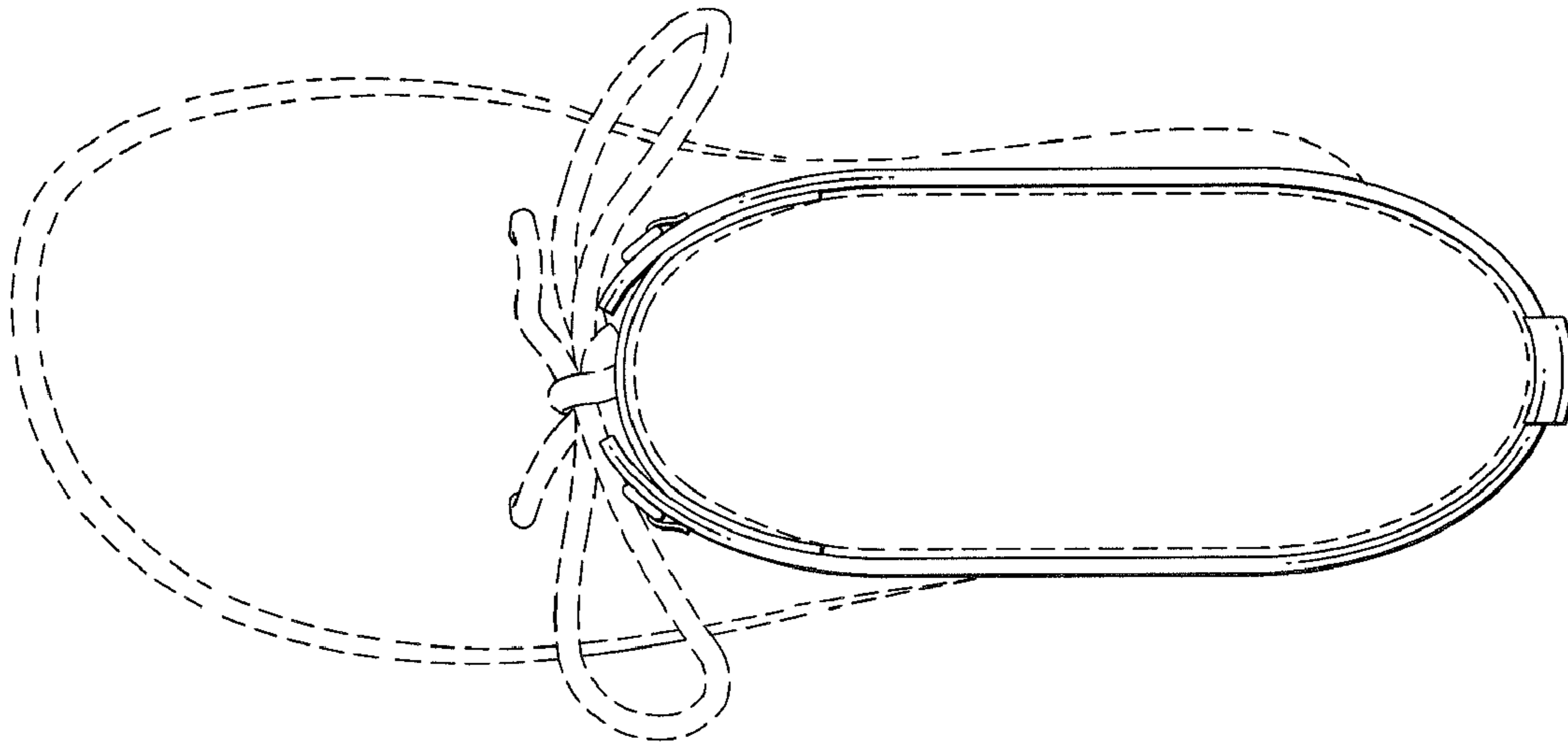

FIG. 6

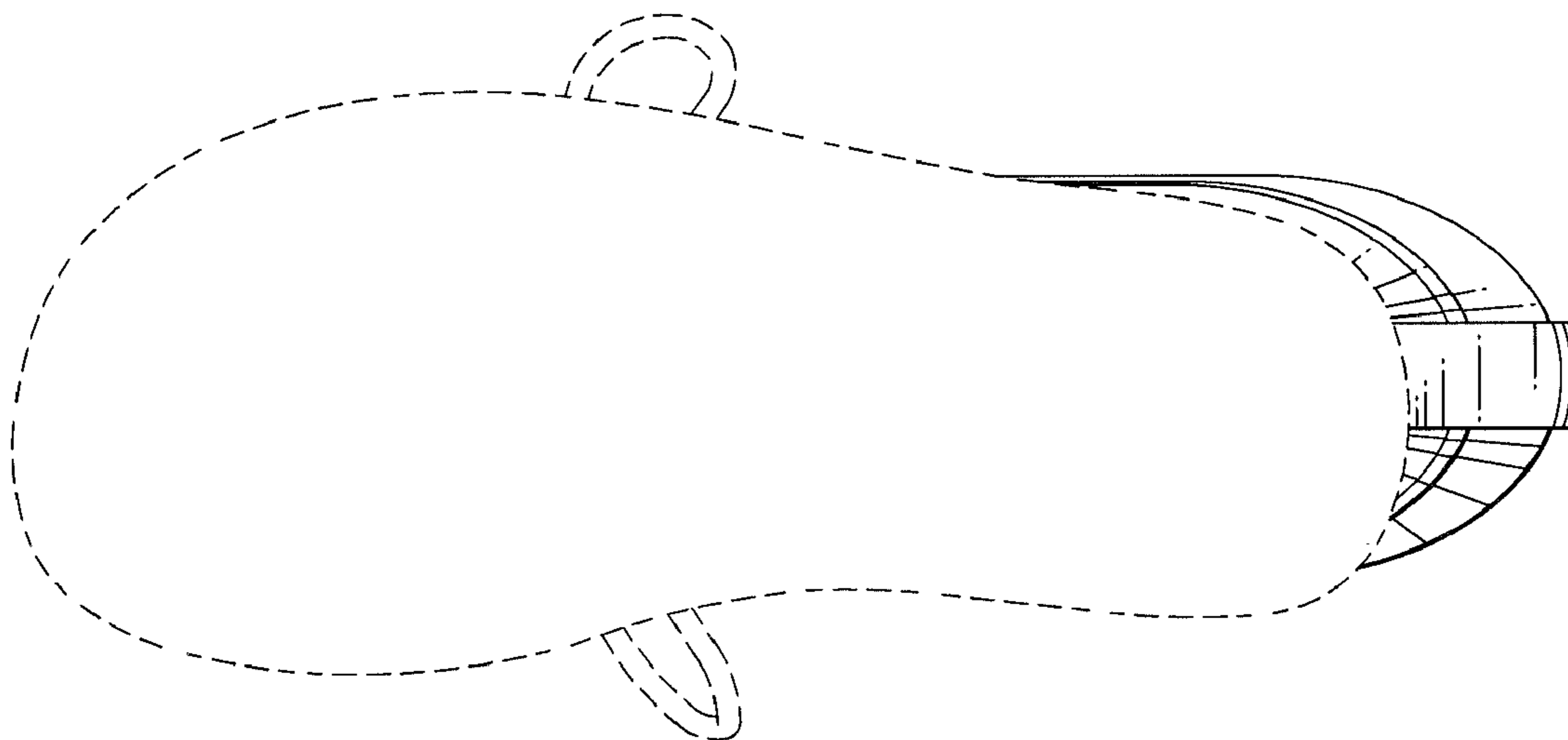

FIG. 7