



US00D634080S

(12) **United States Design Patent**
Rutherford et al.

(10) **Patent No.:** **US D634,080 S**
(45) **Date of Patent:** **** Mar. 8, 2011**

(54) **PET TOY**

(75) Inventors: **Ryan Rutherford**, Belleville, NJ (US);
Andrea Matz, Stanhope, NJ (US)

(73) Assignee: **J. W. Pet Company, Inc.**, Teterboro, NJ
(US)

(**) Term: **14 Years**

(21) Appl. No.: **29/362,588**

(22) Filed: **May 27, 2010**

Related U.S. Application Data

(62) Division of application No. 29/352,521, filed on Dec. 22, 2009, now Pat. No. Des. 624,713, which is a division of application No. 29/317,928, filed on May 9, 2008, now Pat. No. Des. 612,552.

(51) **LOC (9) Cl.** **30-99**

(52) **U.S. Cl.** **D30/160**

(58) **Field of Classification Search** D21/387;
D30/119, 148, 160; 119/702, 706-711; 168/4,
168/13, 24, 29

See application file for complete search history.

(56) **References Cited**

U.S. PATENT DOCUMENTS

D29,938	S	*	1/1899	Paar	D30/147
839,432	A	*	12/1906	Smith	168/13
5,353,878	A	*	10/1994	Lee	168/13
5,421,415	A	*	6/1995	Wells	168/4
6,497,293	B1	*	12/2002	Miller	168/24
D483,530	S	*	12/2003	Bruns	D30/148
7,409,818	B2	*	8/2008	Llewellyn	168/4
D587,860	S	*	3/2009	Jensen	D30/148
D621,104	S	*	8/2010	Partain et al.	D30/160

* cited by examiner

Primary Examiner — Cathy Anne MacCormac

(74) *Attorney, Agent, or Firm* — Katten Muchin Rosenman LLP

(57) **CLAIM**

The ornamental designs for a pet toy, as shown and described.

DESCRIPTION

FIG. 1 is a perspective view of the pet toy;
FIG. 2 is a front view thereof;
FIG. 3 is a rear view thereof;
FIG. 4 is a left side view thereof;
FIG. 5 is a right side view thereof;
FIG. 6 is a top view thereof; and,
FIG. 7 is a bottom view thereof.

The portions of the designs that are shown in broken lines do not form part of the claimed design.

1 Claim, 5 Drawing Sheets

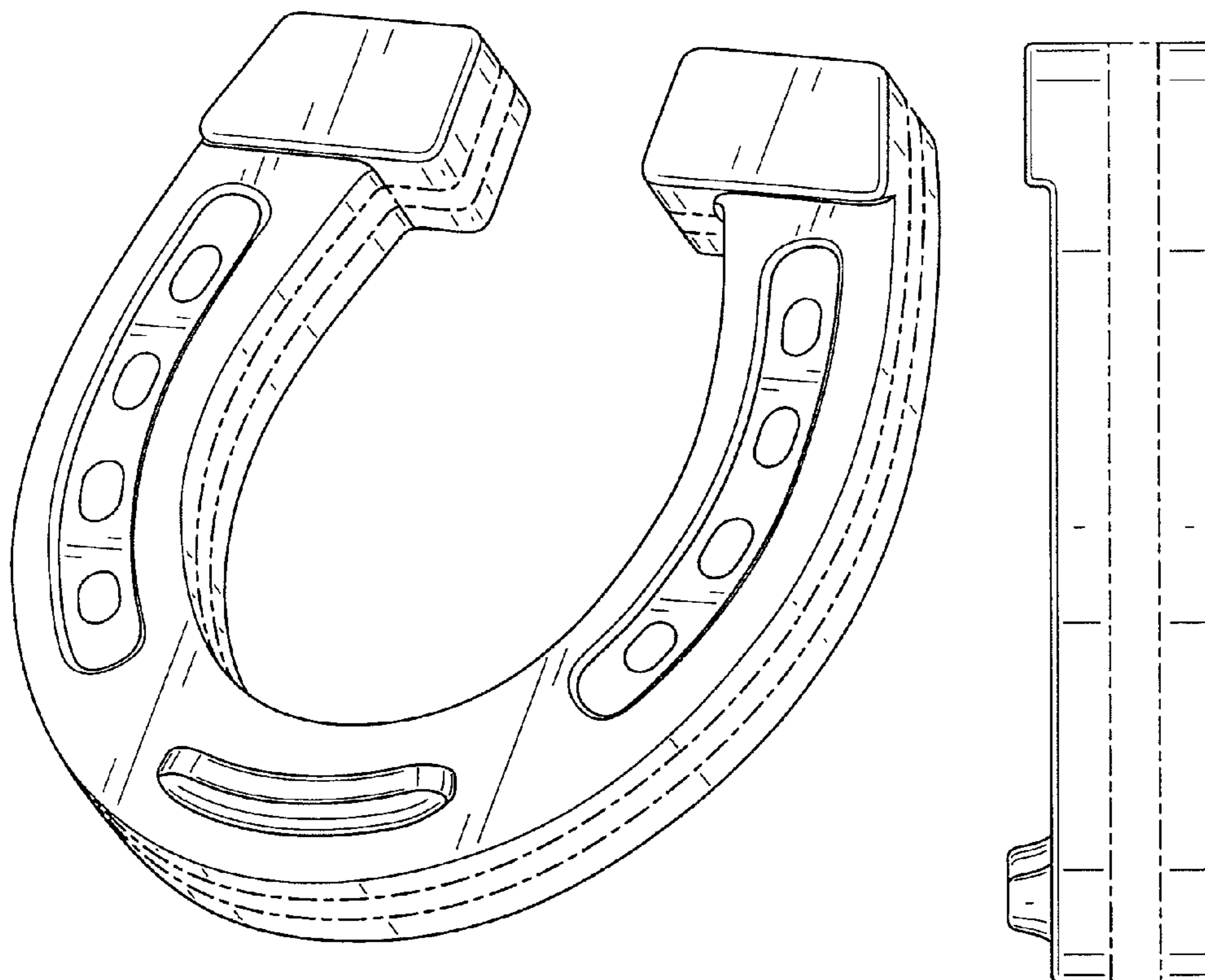

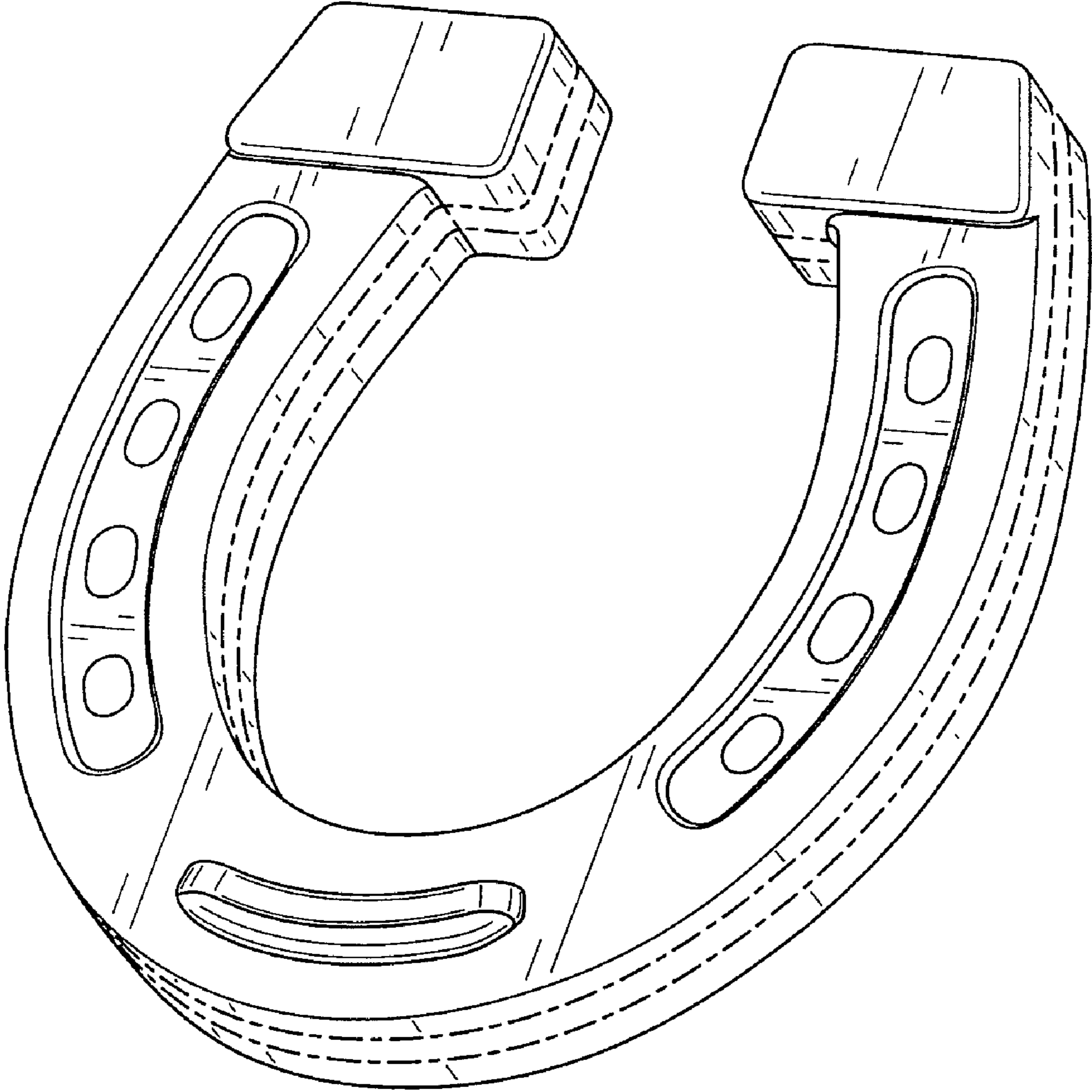

FIG. 1

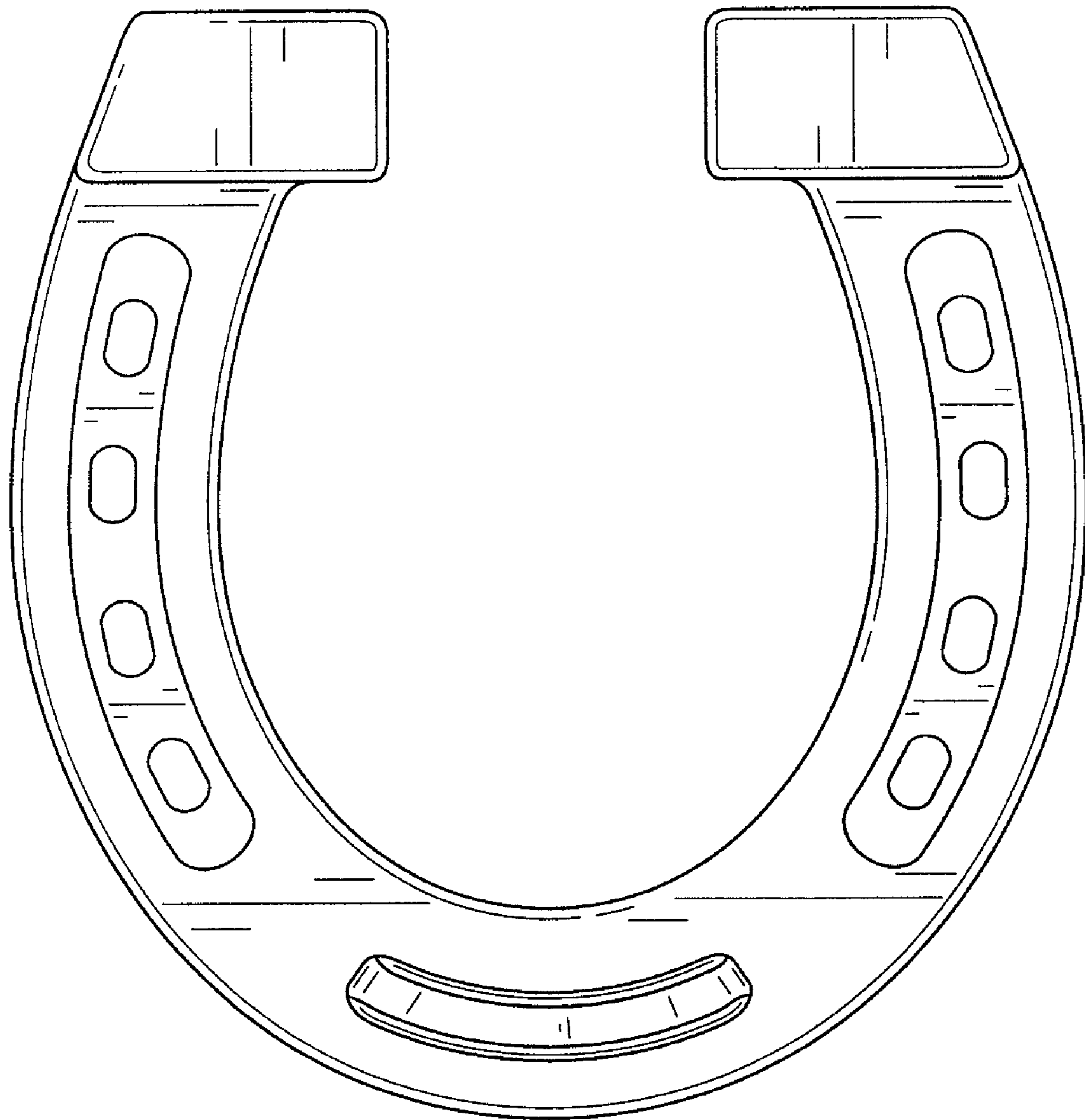

FIG. 2

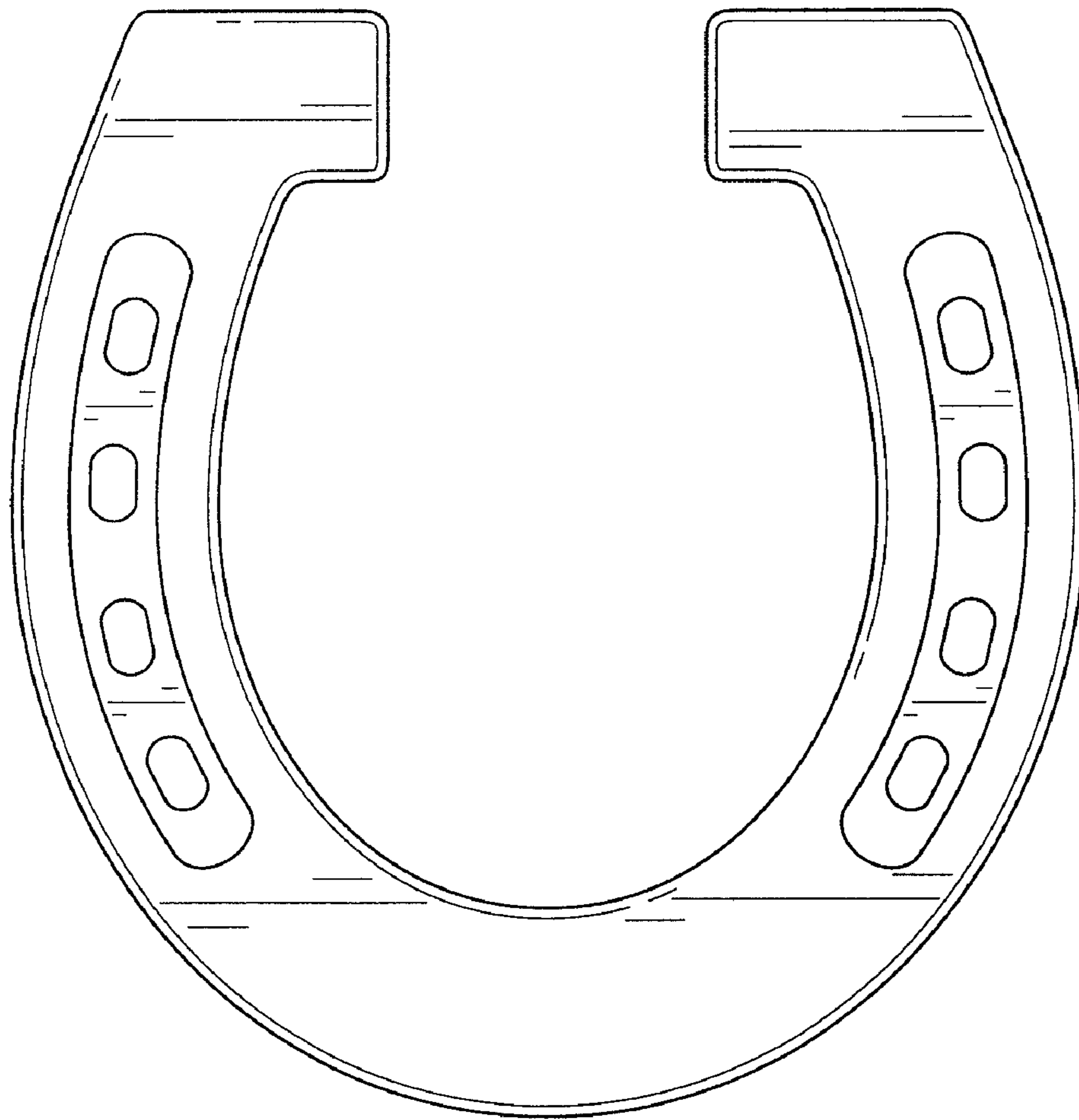

FIG. 3

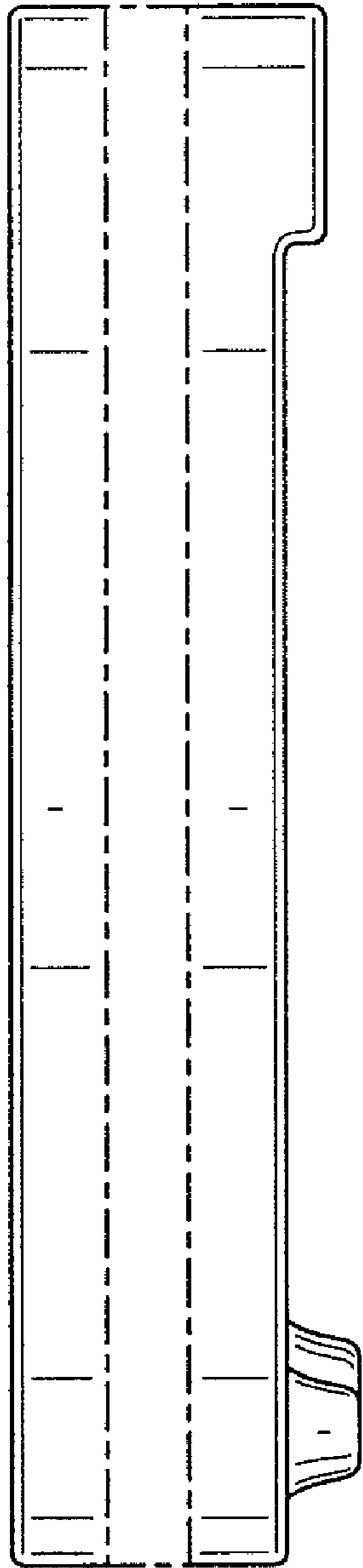

FIG. 4

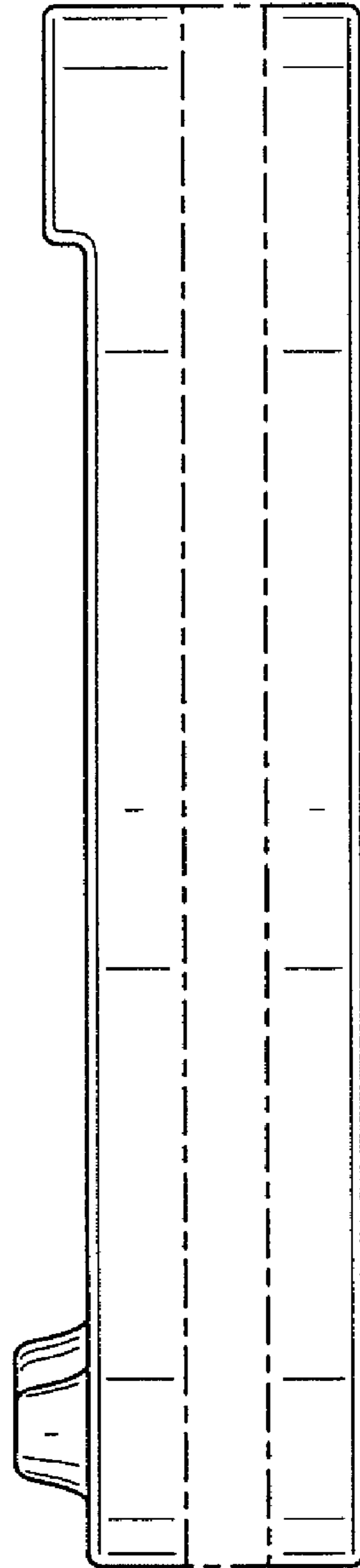

FIG. 5

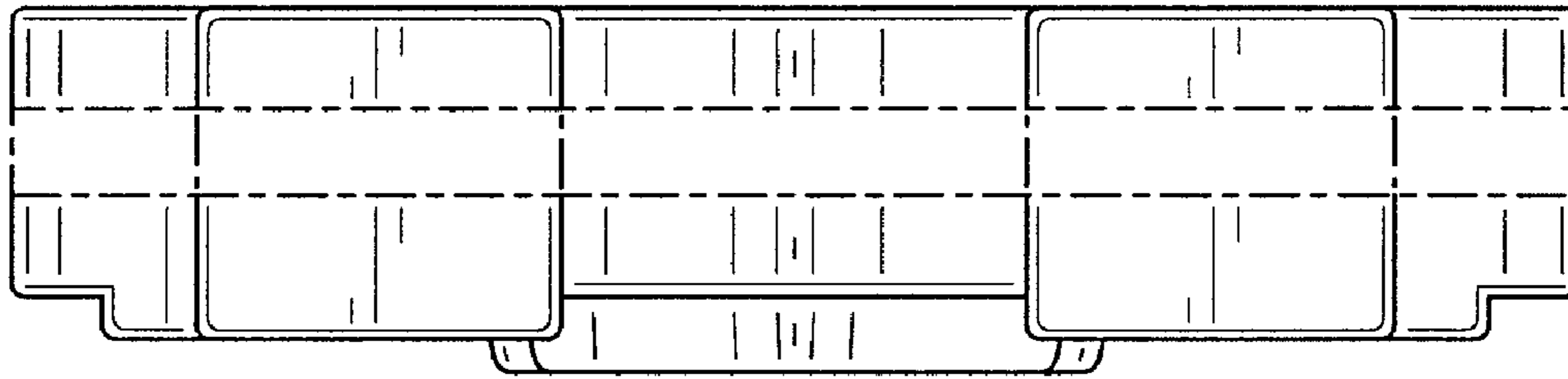

FIG. 6

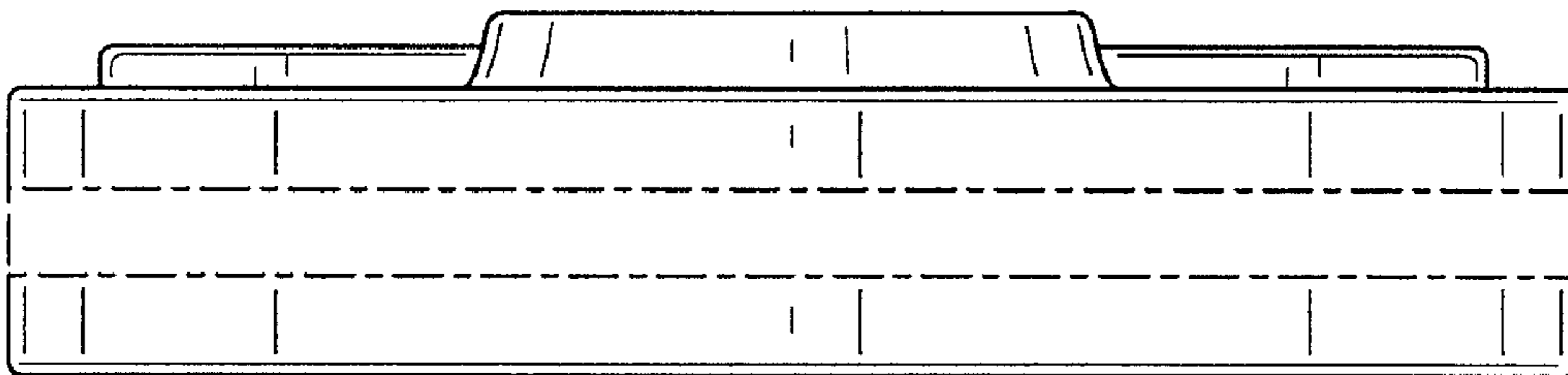

FIG. 7