



US00D633831S

(12) **United States Design Patent**
Matei et al.

(10) **Patent No.:** **US D633,831 S**
(45) **Date of Patent:** **** Mar. 8, 2011**

(54) **VEHICLE GRILLE**

D622,634 S * 8/2010 Yamamoto et al. D12/91

(75) Inventors: **Catalin Matei**, Redondo Beach, CA
(US); **Calvin Liu**, Huntington Beach,
CA (US)

* cited by examiner

Primary Examiner—Melody N Brown
(74) *Attorney, Agent, or Firm*—Plumsea Law Group, LLC;
Mark E. Duell

(73) Assignee: **Honda Motor Co., Ltd.**, Tokyo (JP)

(**) Term: **14 Years**

(57) **CLAIM**

(21) Appl. No.: **29/355,684**

The ornamental design for a vehicle grille, as shown and described.

(22) Filed: **Feb. 11, 2010**

DESCRIPTION

(51) **LOC (9) Cl.** **12-16**

FIG. 1 is a perspective view of a vehicle grille showing our new design;

(52) **U.S. Cl.** **D12/163**

FIG. 2 is a front elevational view thereof;

(58) **Field of Classification Search** D12/163,
D12/196, 171, 169, 216, 90-92, 86; 180/68.1,
180/68.6; 296/193.11

FIG. 3 is a side elevational view of one side thereof;

See application file for complete search history.

FIG. 4 is a side elevational view of the other side thereof;

FIG. 5 is a top plan view thereof; and,

(56) **References Cited**

FIG. 6 is a cross-section taken along line 6-6 in FIG. 2.

U.S. PATENT DOCUMENTS

The broken line showings of the marquee and the remainder of the vehicle form no part of the claimed design.

- D599,705 S * 9/2009 Konaka et al. D12/91
- D614,543 S * 4/2010 Kitazumi et al. D12/163
- D615,463 S * 5/2010 Frei et al. D12/163

1 Claim, 6 Drawing Sheets

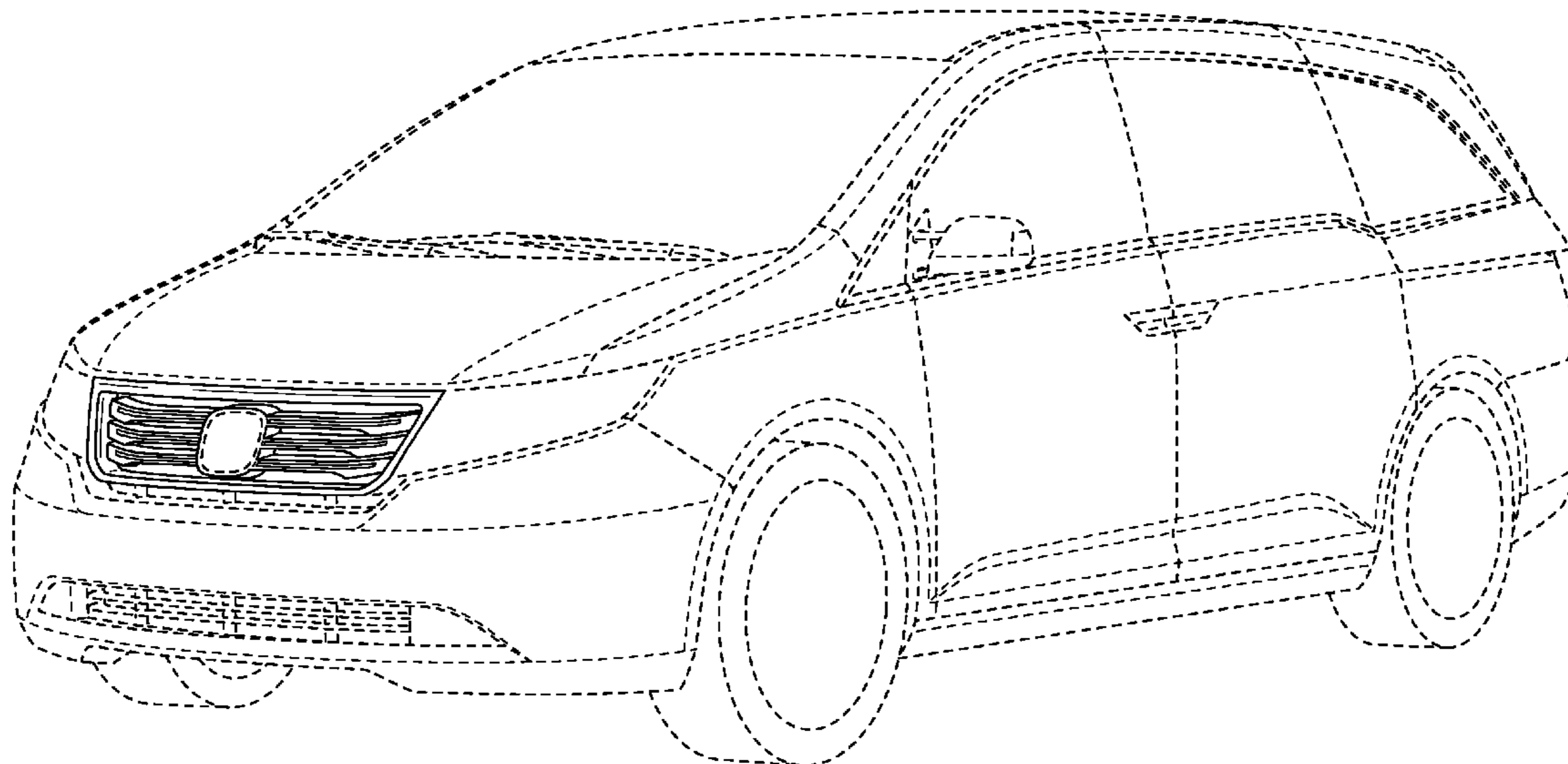

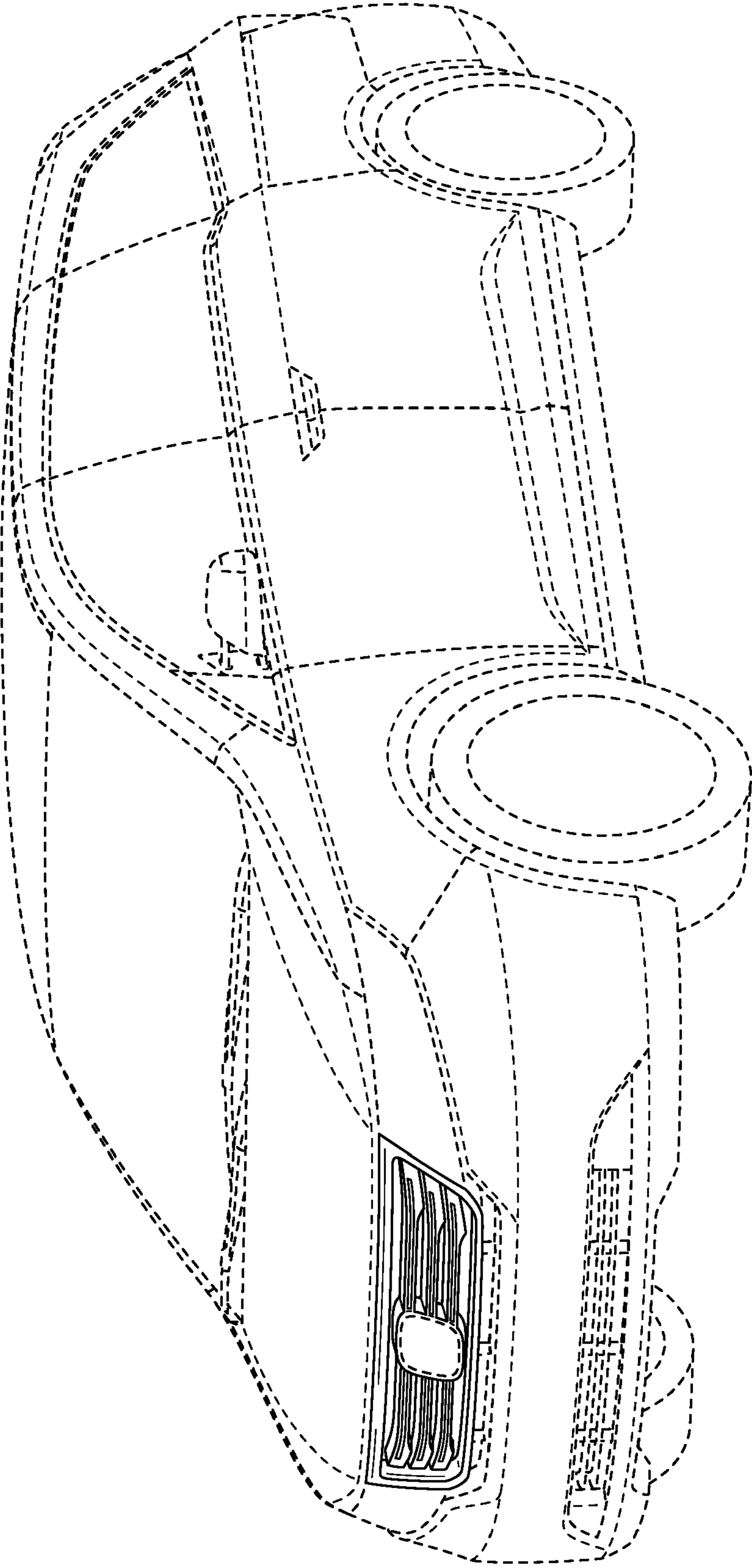

FIG. 1

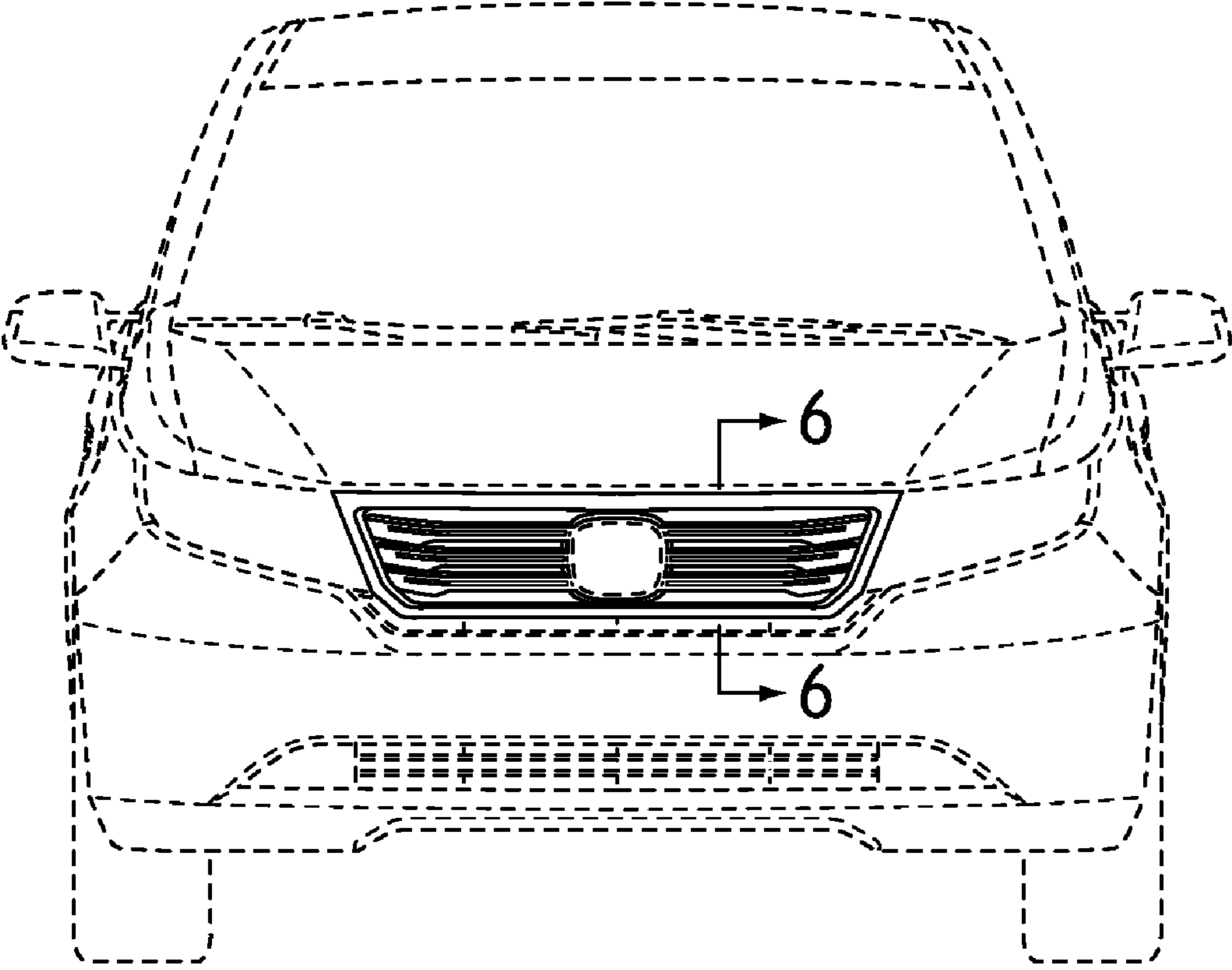

FIG. 2

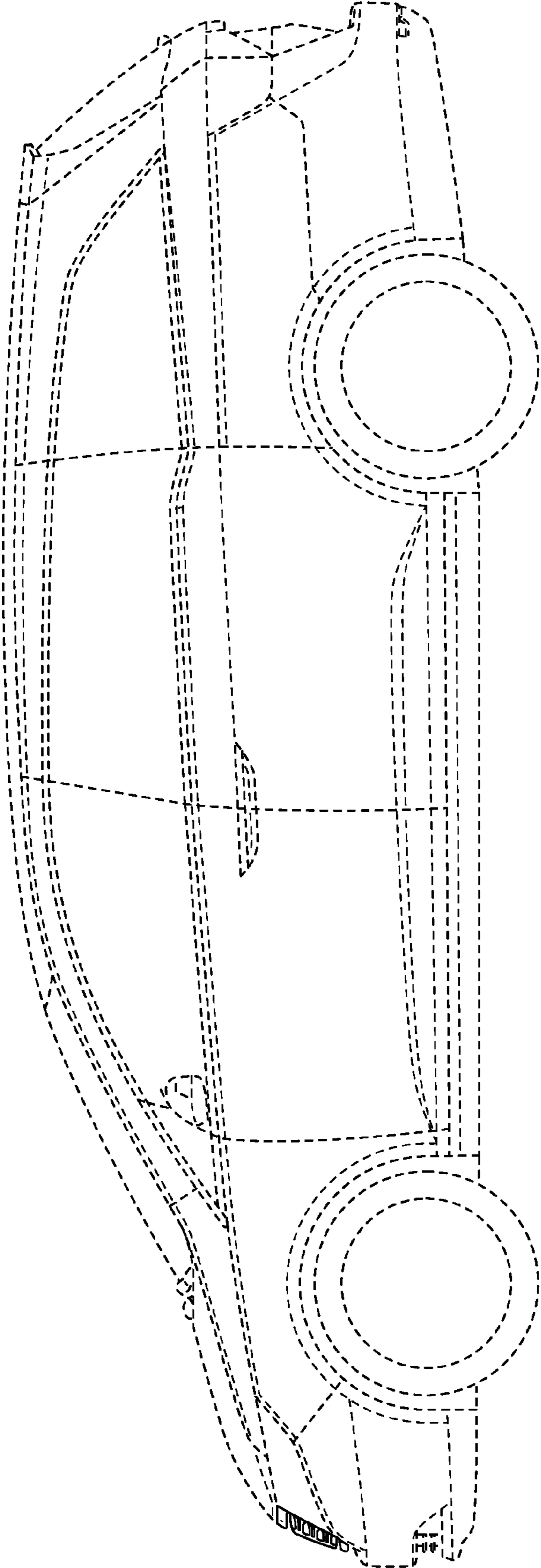

FIG. 3

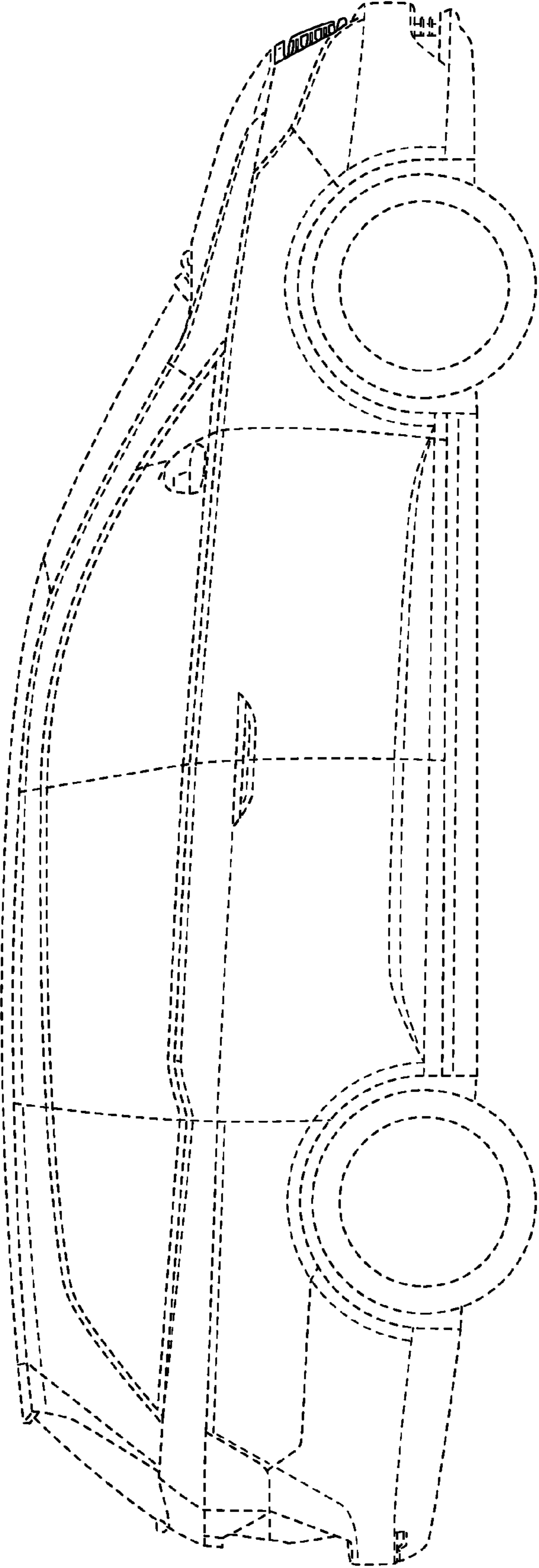

FIG. 4

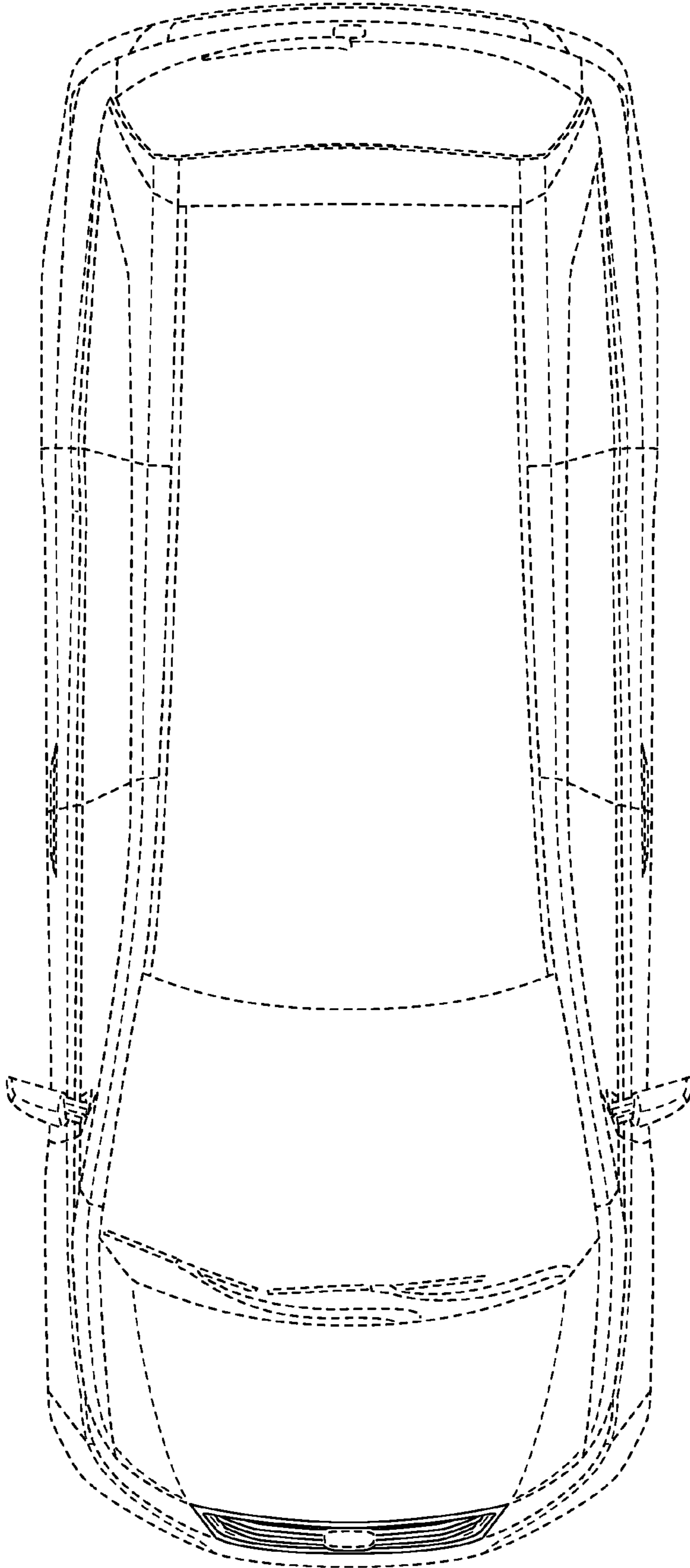

FIG. 5

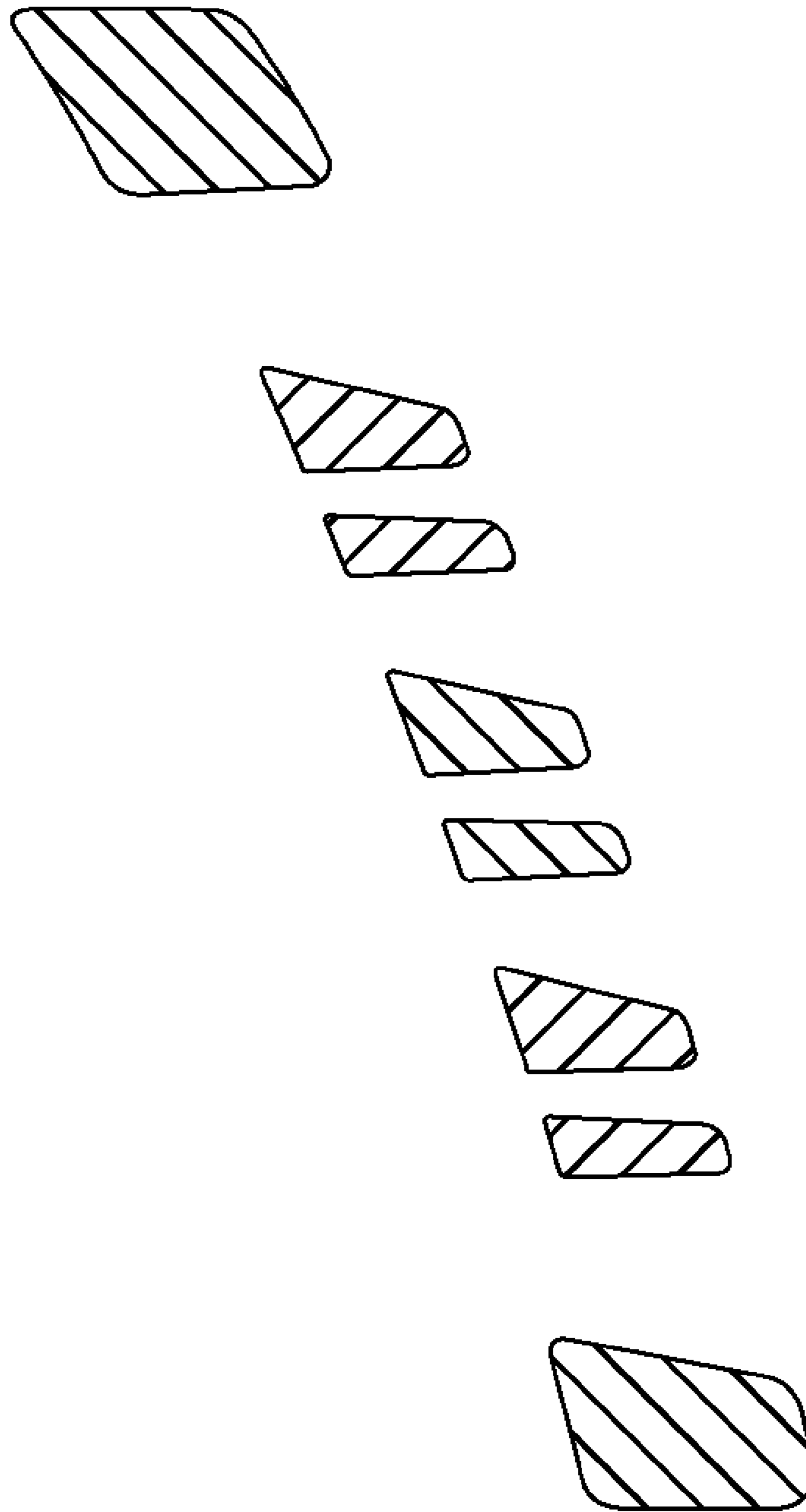

FIG. 6