



US00D633785S

(12) **United States Design Patent**  
**Larson**

(10) **Patent No.:** **US D633,785 S**  
(45) **Date of Patent:** **\*\* Mar. 8, 2011**

(54) **QUICK-CONNECT DUCT ATTACHING DEVICE**

(76) Inventor: **David W. Larson**, Upland, CA (US)

(\*\*) Term: **14 Years**

(21) Appl. No.: **29/288,566**

(22) Filed: **Jun. 18, 2007**

(51) **LOC (9) Cl.** ..... **08-08**

(52) **U.S. Cl.** ..... **D8/396**

(58) **Field of Classification Search** ..... D8/1, 354-356,  
D8/371, 376, 394-396, 382; 24/16 R, 279;  
248/49, 58-62, 74.1-74.5, 73, 70, 228.8,  
248/230.8; 47/32.4-32.6, 42

See application file for complete search history.

(56) **References Cited**

**U.S. PATENT DOCUMENTS**

1,086,442	A *	2/1914	Cornelius	.....	248/59
1,362,244	A *	12/1920	Farley	.....	248/59
3,169,005	A *	2/1965	Wallach	.....	248/74.3
3,330,517	A *	7/1967	Zimmerman	.....	248/62
3,521,401	A *	7/1970	Shisler	.....	47/43
4,333,624	A *	6/1982	Raddatz	.....	248/205.1
4,713,863	A *	12/1987	Jennings	.....	24/20 R
4,742,600	A *	5/1988	Calmettes et al.	.....	24/20 R
5,056,196	A *	10/1991	van Walraven	.....	24/279
5,097,798	A *	3/1992	Little	.....	119/72
5,522,571	A *	6/1996	Simmons	.....	248/59
5,533,696	A *	7/1996	Laughlin et al.	.....	248/74.2

6,568,043	B1 *	5/2003	Detable et al.	.....	24/20 R
7,185,399	B2 *	3/2007	Logan	.....	24/16 R
2006/0180715	A1 *	8/2006	Duggan	.....	248/65

\* cited by examiner

*Primary Examiner* — Celia A Murphy

*Assistant Examiner* — John Windmuller

(74) *Attorney, Agent, or Firm* — Albert O. Cota

(57) **CLAIM**

The ornamental design for a quick-connect duct attaching device, as shown and described.

**DESCRIPTION**

FIG. 1 is a perspective view of a quick-connect duct attaching device showing my new design.

FIG. 2 is an elevational view thereof;

FIG. 3 is a top plan view thereof showing a latch opening that has been centrally cut to produce a T-latch that is inserted into a latch notch;

FIG. 4 is a bottom plan view thereof;

FIG. 5 is a right-side elevational view thereof, the left-side elevational view being a mirror image thereof; and,

FIG. 6 is an edge view thereof.

The device is shown broken away in the figures to indicate that it has no specific length.

The building structure and the duct are shown in broken lines for illustrative purposes only and form no part of the claimed design.

**1 Claim, 3 Drawing Sheets**

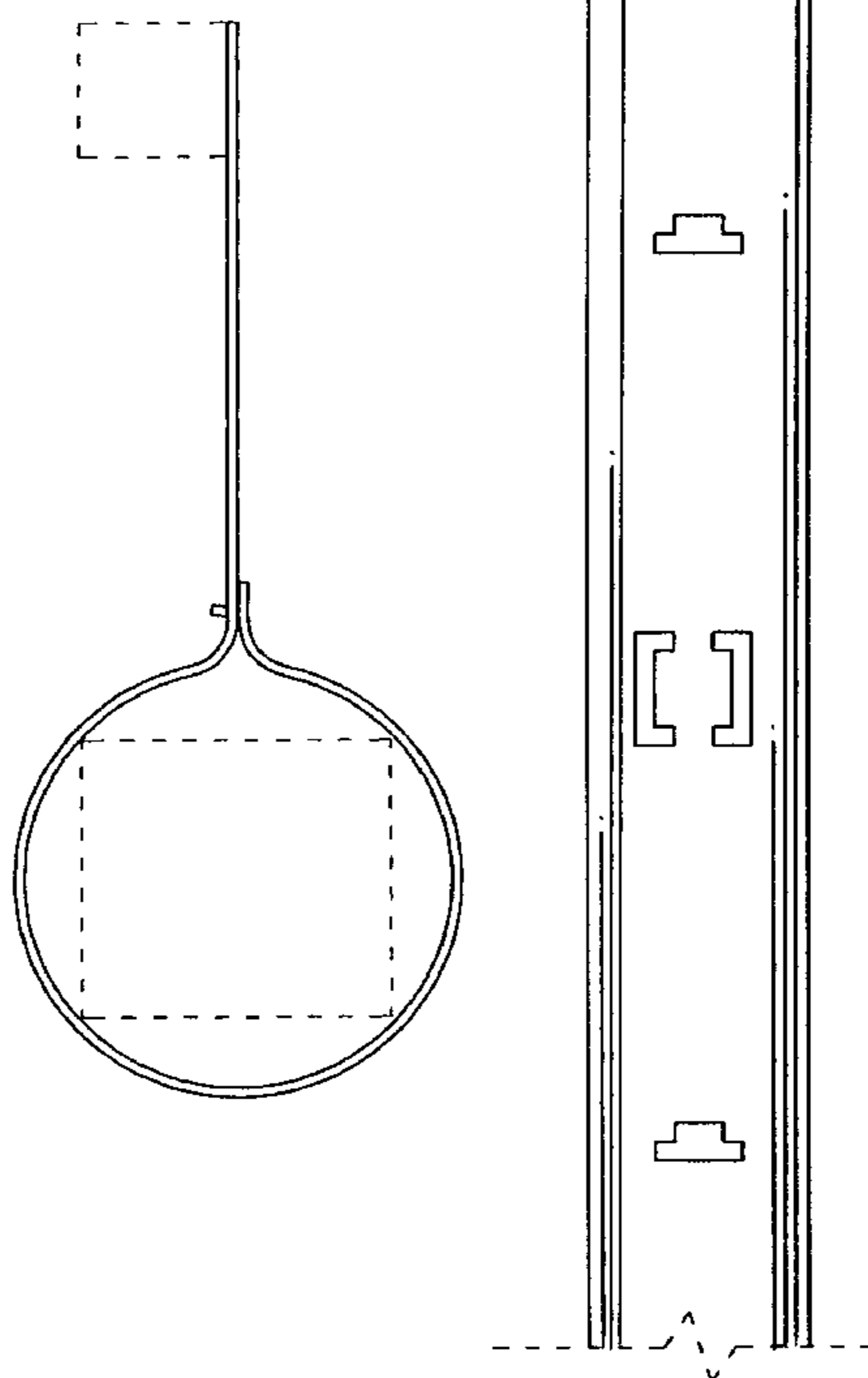

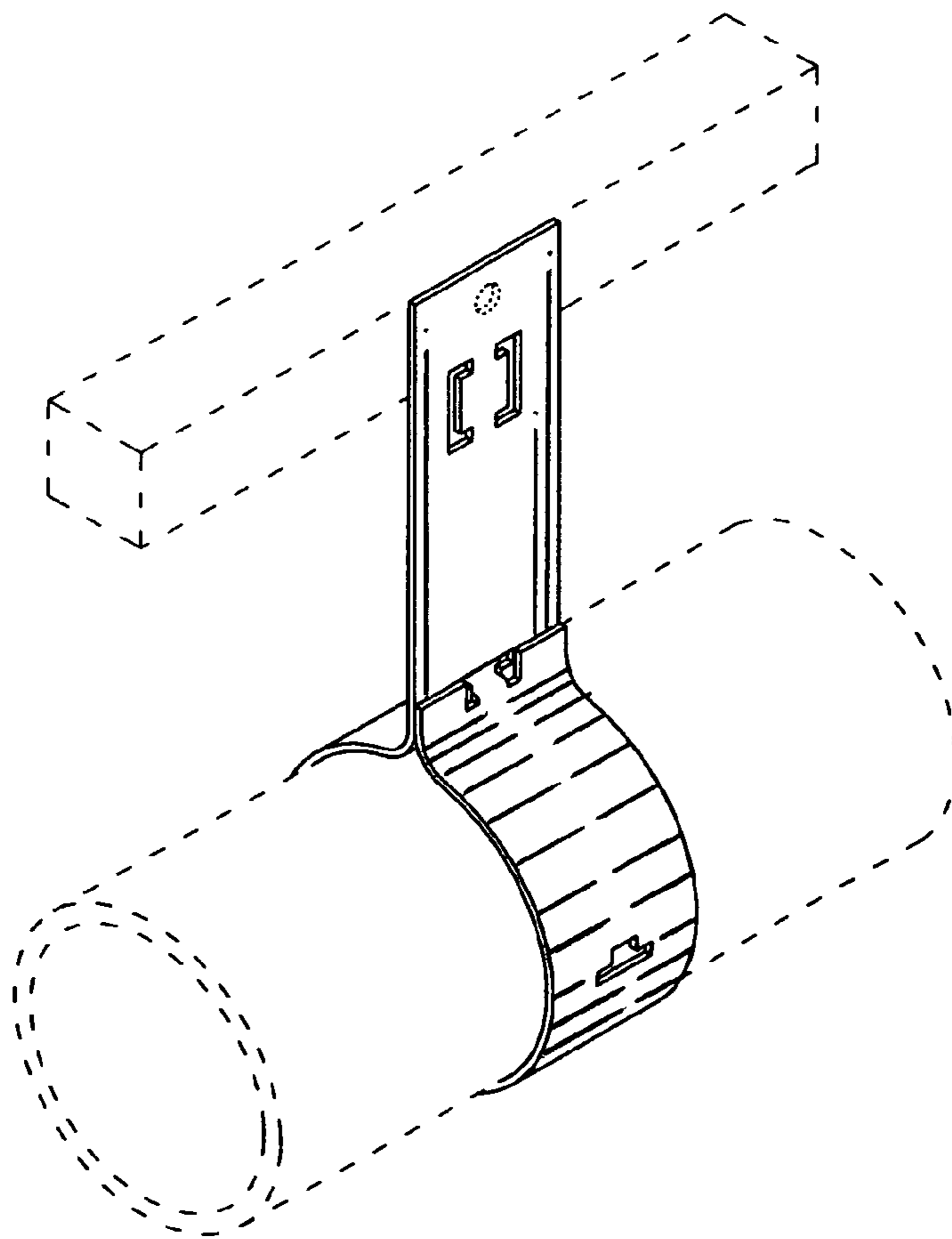

Fig. 1

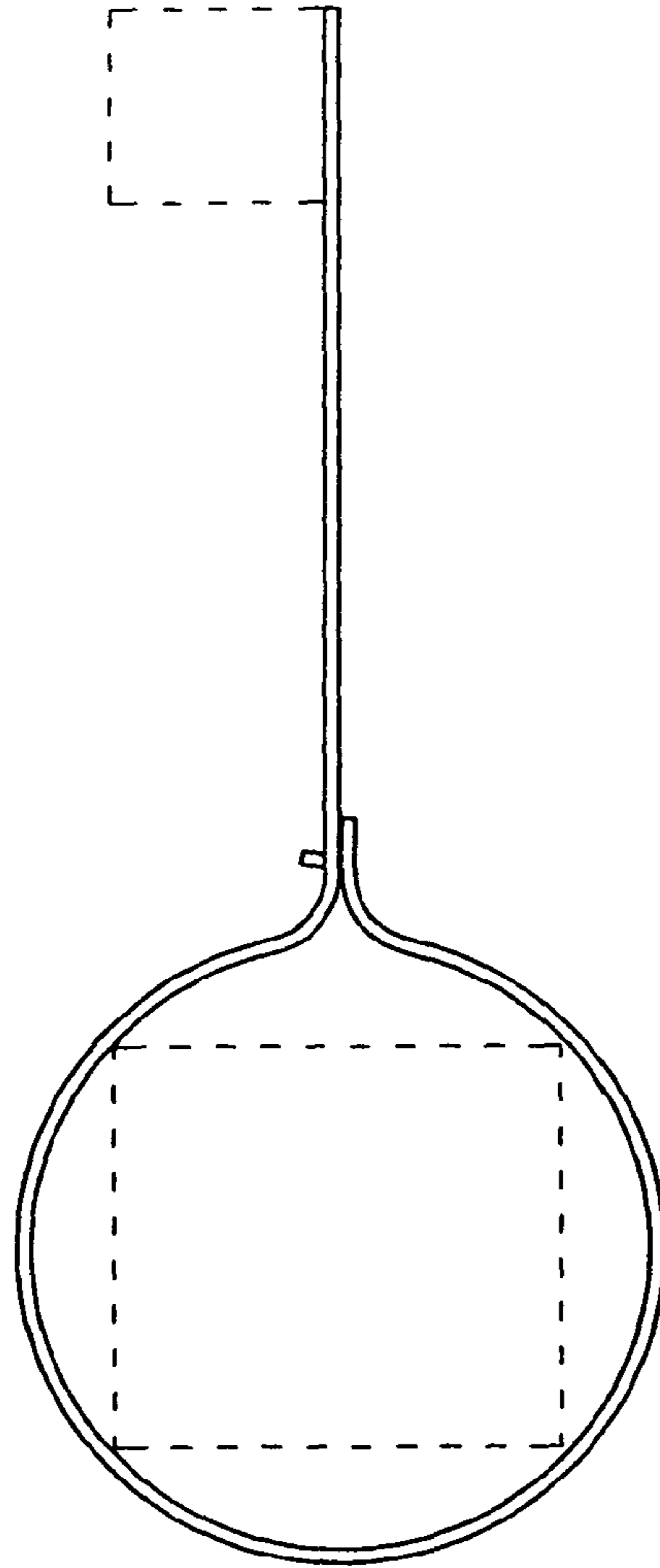

Fig. 2

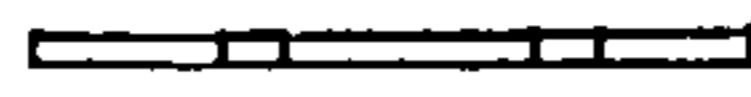

Fig. 6

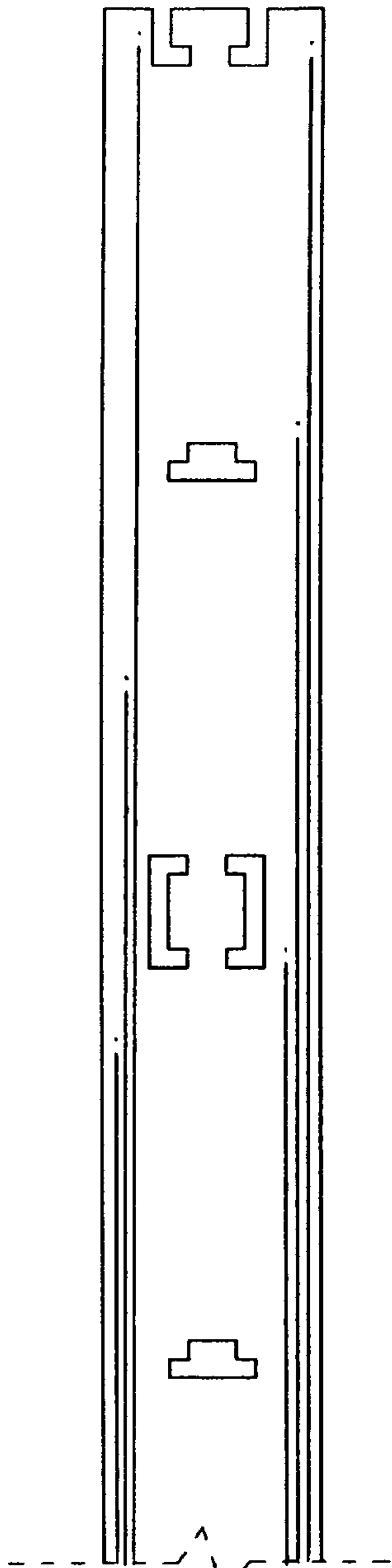

Fig. 3

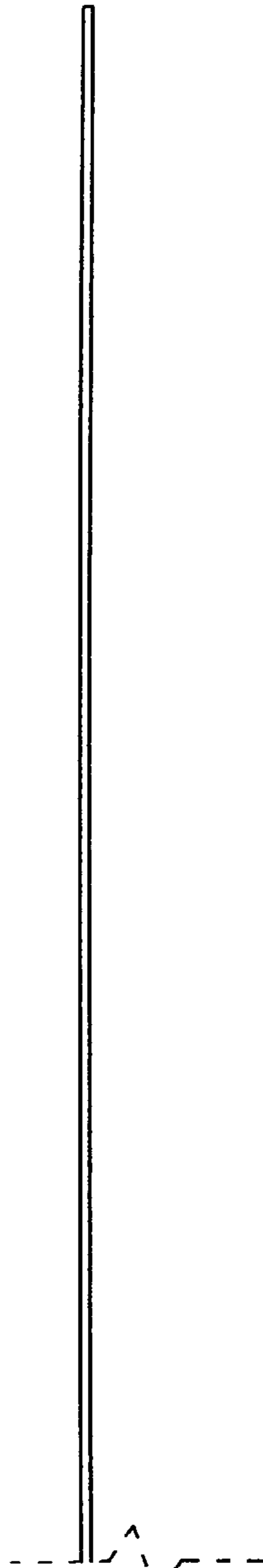

Fig. 5

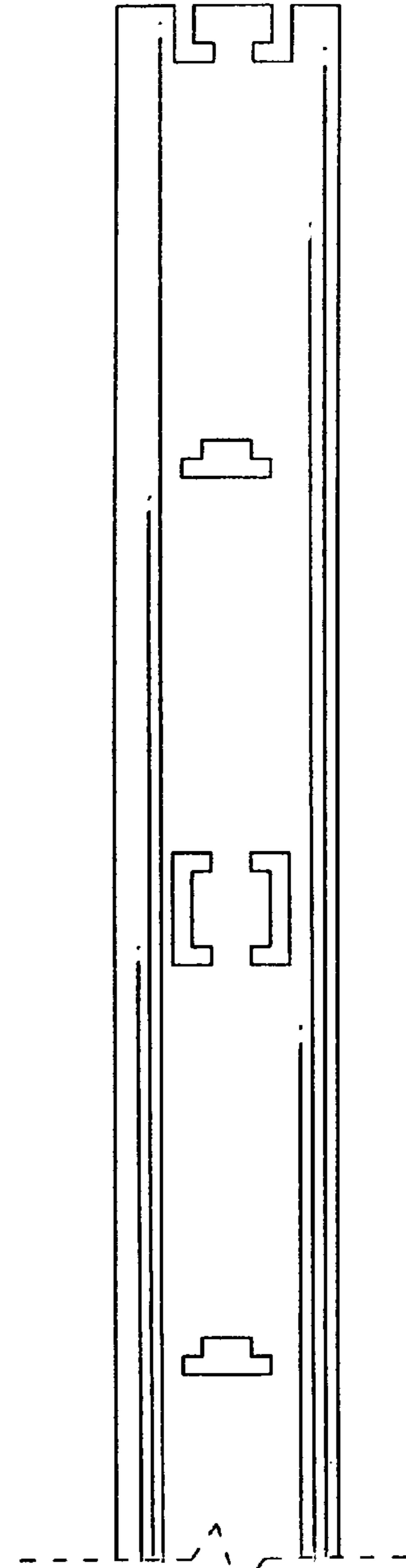

Fig. 4