



US00D633760S

(12) **United States Design Patent**
Rayburn et al.

(10) **Patent No.:** **US D633,760 S**
(45) **Date of Patent:** **** Mar. 8, 2011**

(54) **BASEBALL BAT-SHAPED COOKING SPATULA**

(75) Inventors: **Robby Rayburn**, El Mirage, AZ (US);
Travis Payne, Peoria, AZ (US); **Richard Gutierrez**, Glendale, AZ (US)

(73) Assignee: **AZ Natives, LLC**, El Mirage, AZ (US)

(**) Term: **14 Years**

(21) Appl. No.: **29/362,826**

(22) Filed: **Jun. 1, 2010**

(51) **LOC (9) Cl.** **07-02**

(52) **U.S. Cl.** **D7/689**

(58) **Field of Classification Search** D7/688-692,
D7/393, 395, 653-664, 368, 669; 294/1.1,
294/7, 8; D32/40, 43, 46

See application file for complete search history.

(56) **References Cited**

U.S. PATENT DOCUMENTS

- D196,878 S * 11/1963 McCain D7/654
- D249,321 S * 9/1978 Mancini D7/654
- D272,661 S * 2/1984 Cutler D28/7
- D426,429 S * 6/2000 Zemel D7/688

* cited by examiner

Primary Examiner—Terry A Wallace

(74) *Attorney, Agent, or Firm*—Venable, Campillo, Logan & Meaney, P.C.

(57) **CLAIM**

The ornamental designs for a baseball bat-shaped cooking spatula, as shown and described.

DESCRIPTION

FIG. 1 is a front view of an embodiment of a baseball bat-shaped cooking spatula;

FIG. 2 is a side view of the baseball bat-shaped cooking spatula embodiment shown in FIG. 1.

FIG. 3 is a top perspective view of the baseball bat-shaped cooking spatula embodiment shown in FIG. 1.

FIG. 4 is a top view of the baseball bat-shaped cooking spatula embodiment shown in FIG. 1.

FIG. 5 is a bottom view of the baseball bat-shaped cooking spatula embodiment shown in FIG. 1.

FIG. 6 is a front view of a second embodiment of a baseball bat-shaped cooking spatula;

FIG. 7 is a side view of the baseball bat-shaped cooking spatula embodiment shown in FIG. 6.

FIG. 8 is a top perspective view of the baseball bat-shaped cooking spatula embodiment shown in FIG. 6.

FIG. 9 is a top view of the baseball bat-shaped cooking spatula embodiment shown in FIG. 6; and,

FIG. 10 is a bottom view of the baseball bat-shaped cooking spatula embodiment shown in FIG. 1.

The broken lines are for illustrative purposes only and form no part of the claimed design.

1 Claim, 4 Drawing Sheets

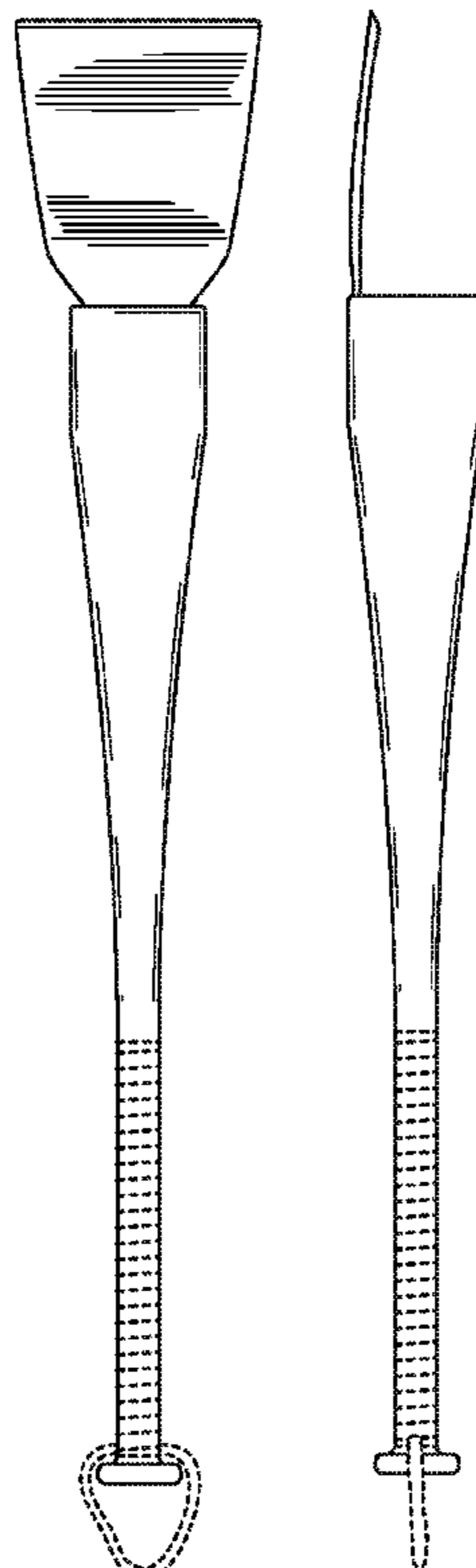

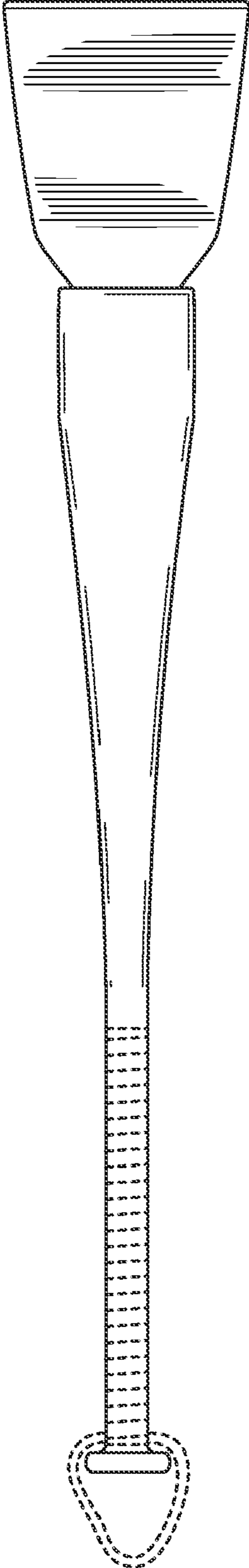

Fig. 1

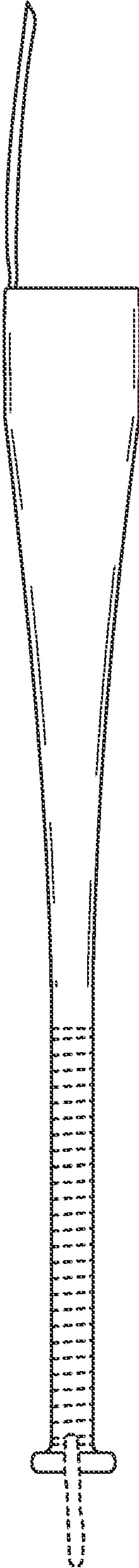

Fig. 2

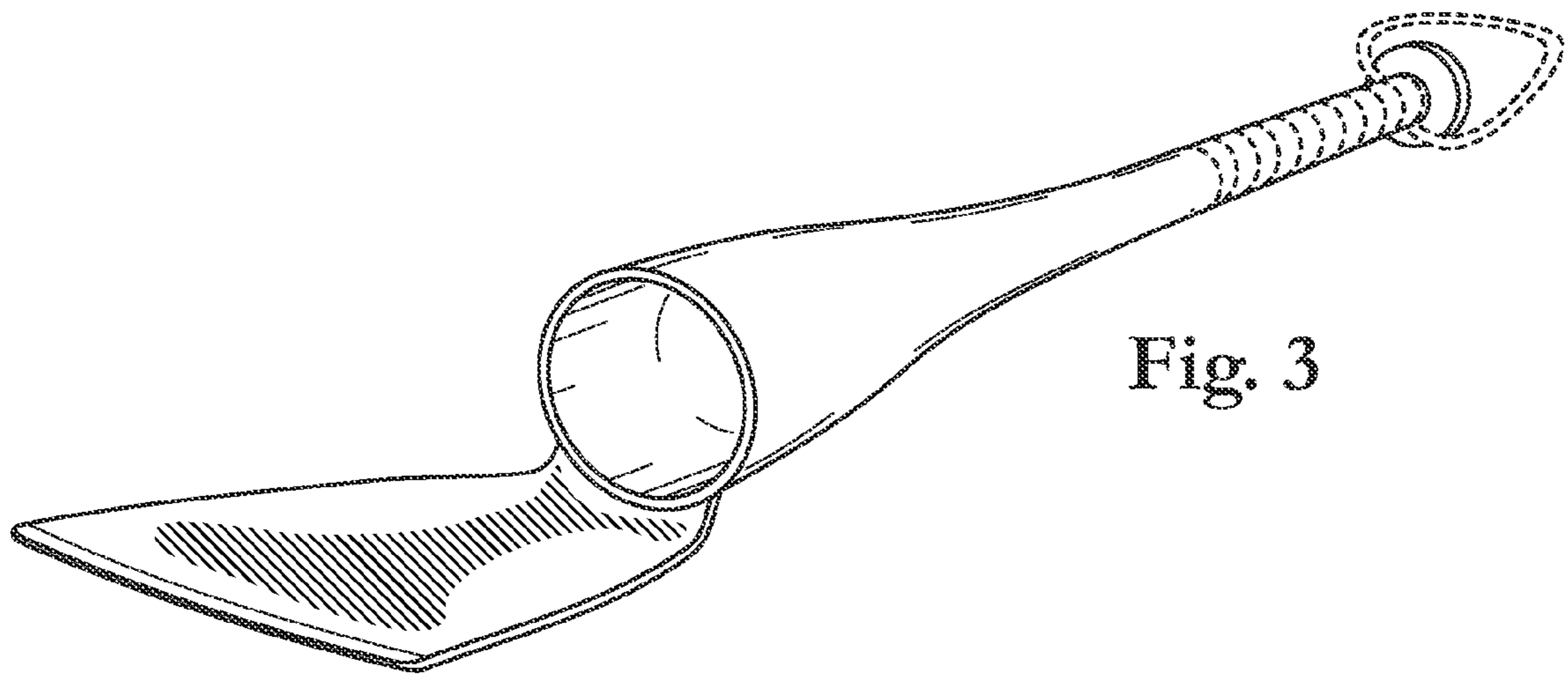

Fig. 3

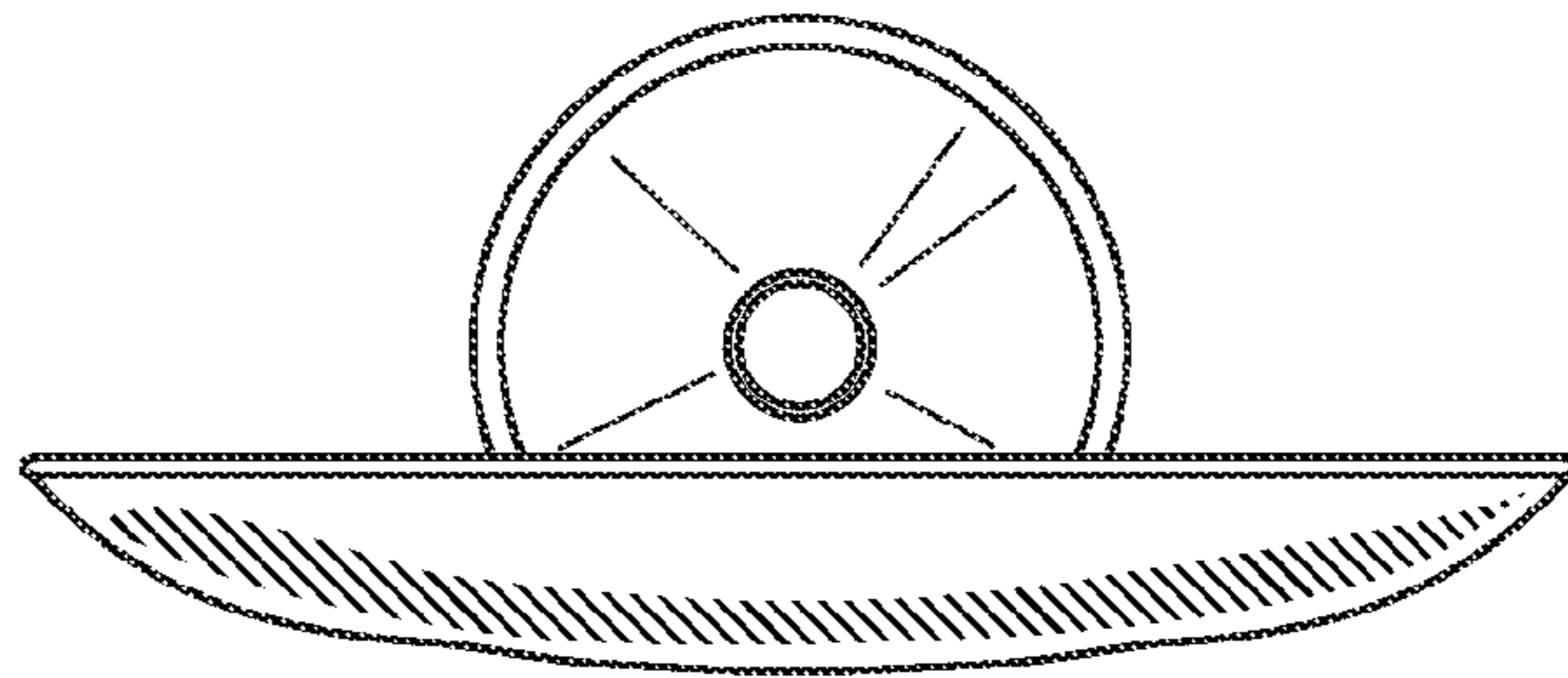

Fig. 4

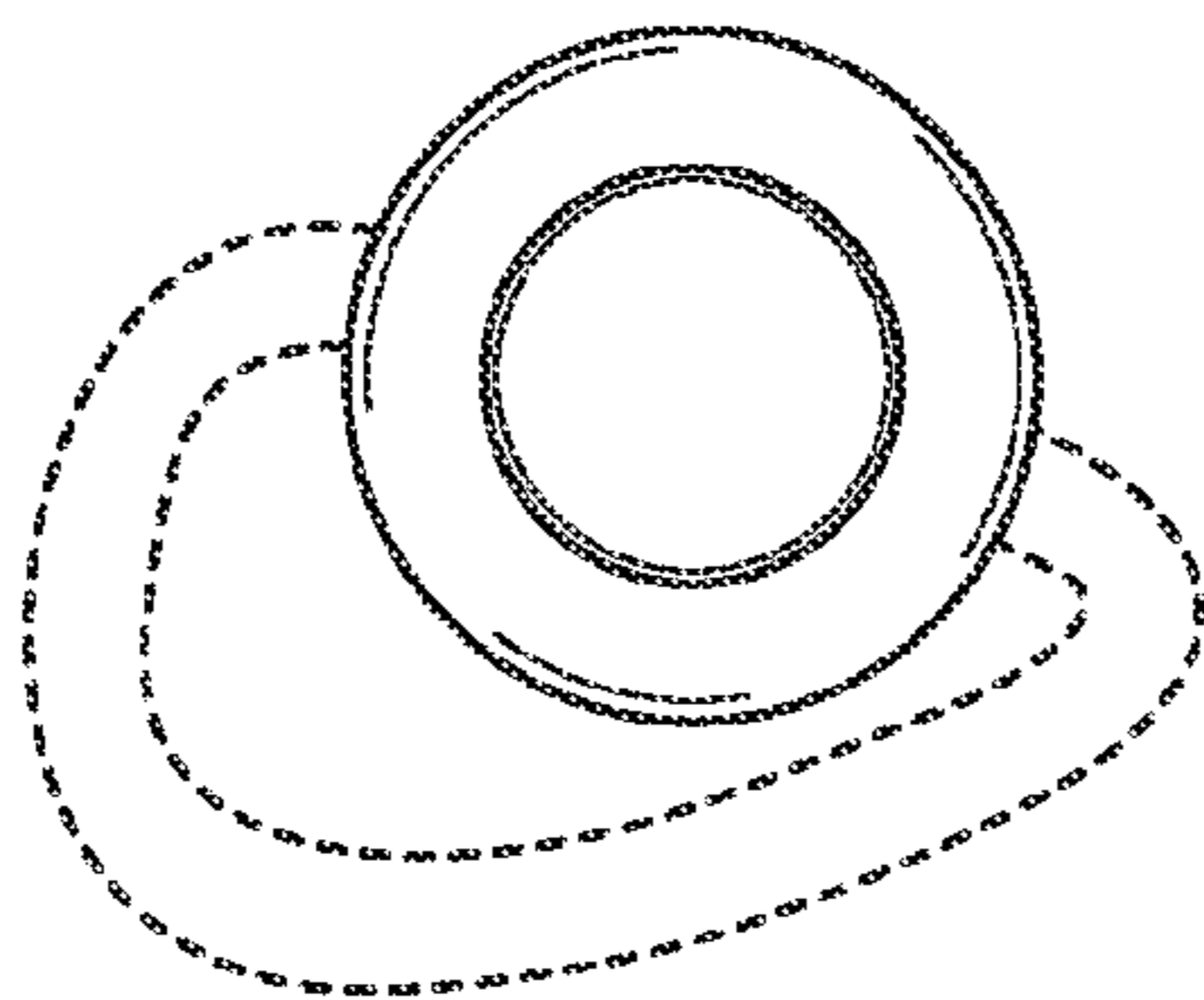

Fig. 5



Fig. 6

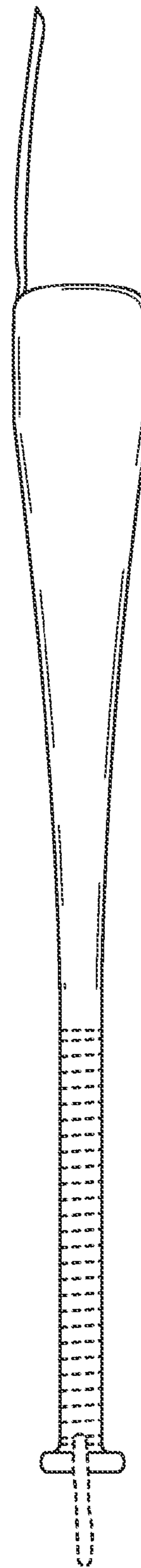

Fig. 7

