



US00D633753S

(12) **United States Design Patent**
White

(10) **Patent No.:** **US D633,753 S**

(45) **Date of Patent:** **** Mar. 8, 2011**

(54) **POURER STOPPER**

(75) Inventor: **Adam White**, London (GB)

(73) Assignee: **Le Creuset SAS**, Fresnoy le Grand (FR)

(**) Term: **14 Years**

(21) Appl. No.: **29/356,329**

(22) Filed: **Feb. 24, 2010**

(30) **Foreign Application Priority Data**

Sep. 4, 2009 (EM) 0011 63679-0001

(51) **LOC (9) Cl.** **07-01**

(52) **U.S. Cl.** **D7/398; D7/392; D9/440**

(58) **Field of Classification Search** D7/392,
D7/398, 397, 387; D9/440, 439; 222/570,
222/478, 421, 484; 220/717

See application file for complete search history.

(56) **References Cited**

U.S. PATENT DOCUMENTS

2,155,049	A *	4/1939	Isaacson	220/717
D182,235	S *	3/1958	Jaffe	D9/454
5,799,836	A *	9/1998	Lee	222/189.07
D418,417	S *	1/2000	Hollinger	D9/440
D421,908	S *	3/2000	Abrams	D9/440
D447,602	S *	9/2001	Dumler et al.	D28/76
6,742,678	B1 *	6/2004	Krystopik, Jr.	222/481.5
D501,359	S *	2/2005	Bodum	D7/397

D520,359	S *	5/2006	Sach	D9/439
D533,776	S *	12/2006	Allen et al.	D9/440
D591,594	S *	5/2009	Jalet	D9/440
D592,906	S *	5/2009	Allen et al.	D7/398
7,658,306	B2 *	2/2010	Allen et al.	222/481.5
D614,443	S *	4/2010	Federighi	D7/398
D624,358	S *	9/2010	Maufette et al.	D7/398
2006/0000855	A1 *	1/2006	Allen et al.	222/484
2008/0272147	A1 *	11/2008	Buker et al.	222/113

* cited by examiner

Primary Examiner—Marianne Pandozzi

(74) *Attorney, Agent, or Firm*—Wood, Herron & Evans, LLP

(57) **CLAIM**

The ornamental design for a pourer stopper, as shown and described.

DESCRIPTION

FIG. 1 is a perspective view of a pourer stopper showing my new design;

FIG. 2 is a front view thereof;

FIG. 3 is a right side view thereof, the left side view being a mirror image thereof;

FIG. 4 is a rear view thereof;

FIG. 5 is a top view thereof;

FIG. 6 is a bottom view thereof; and,

FIG. 7 is a cross-sectional taken along line 7—7 of FIG. 2.

1 Claim, 2 Drawing Sheets

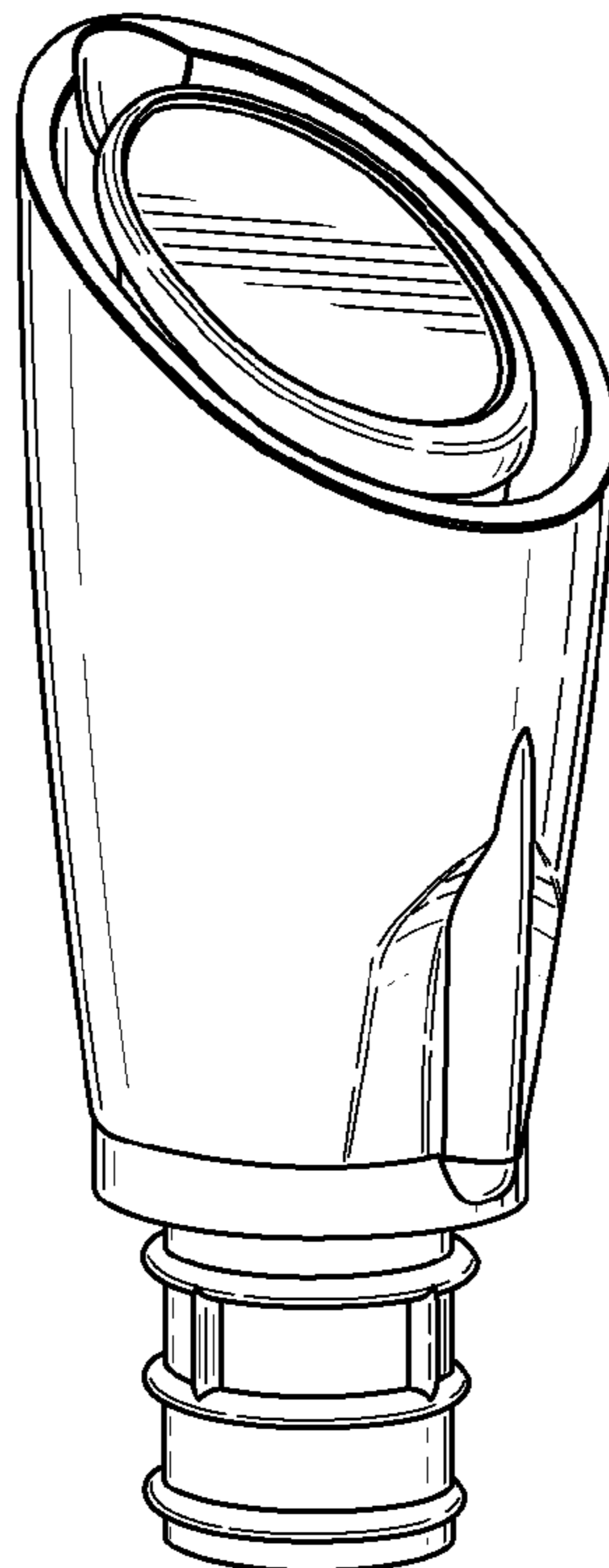

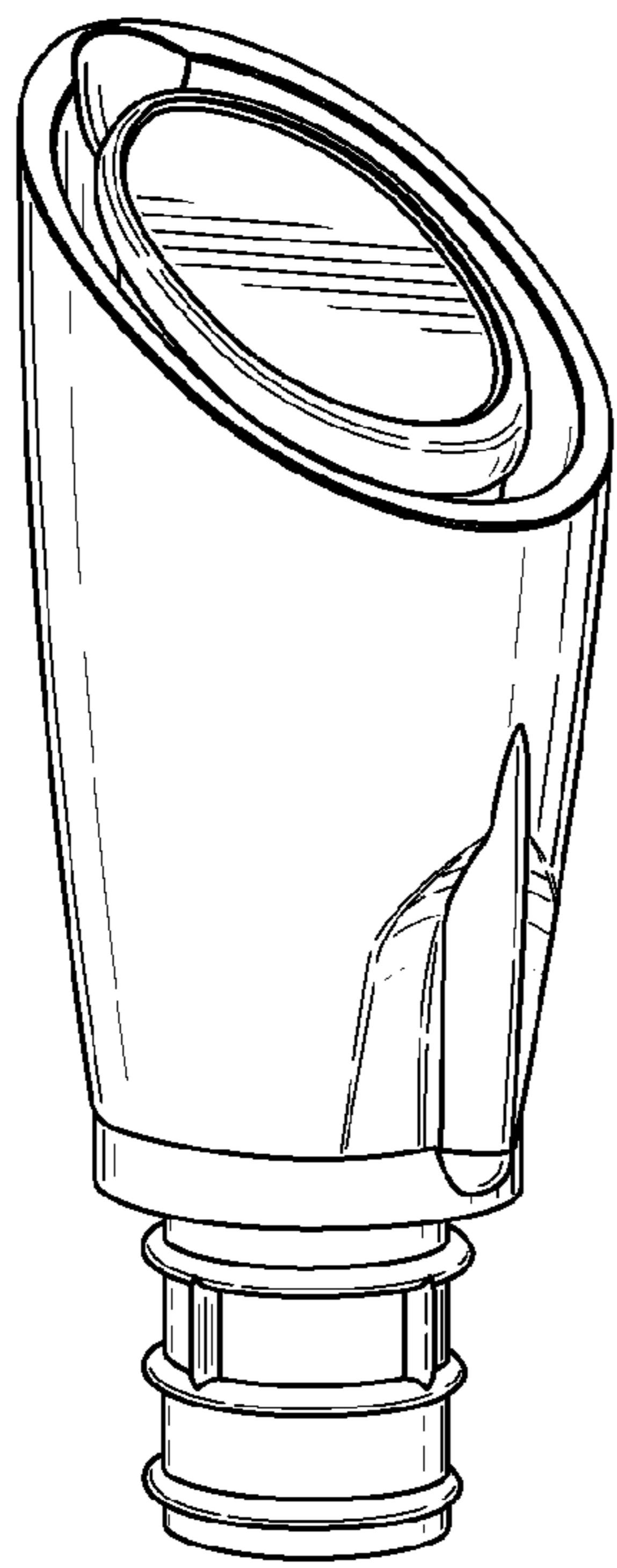

FIG. 1

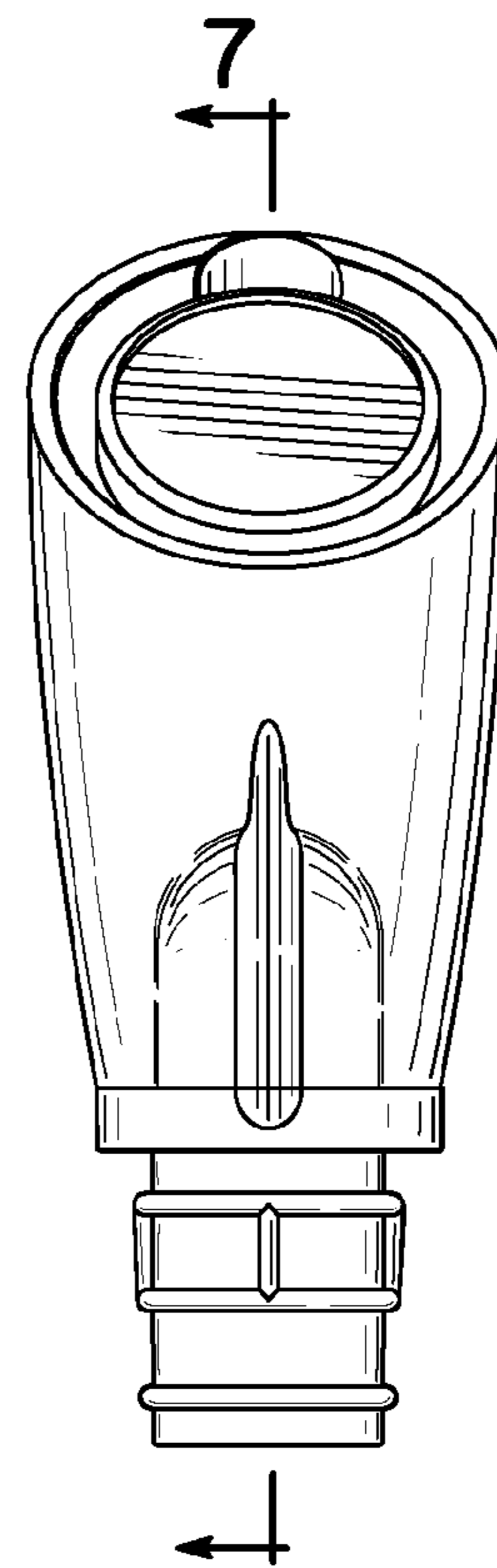

FIG. 2

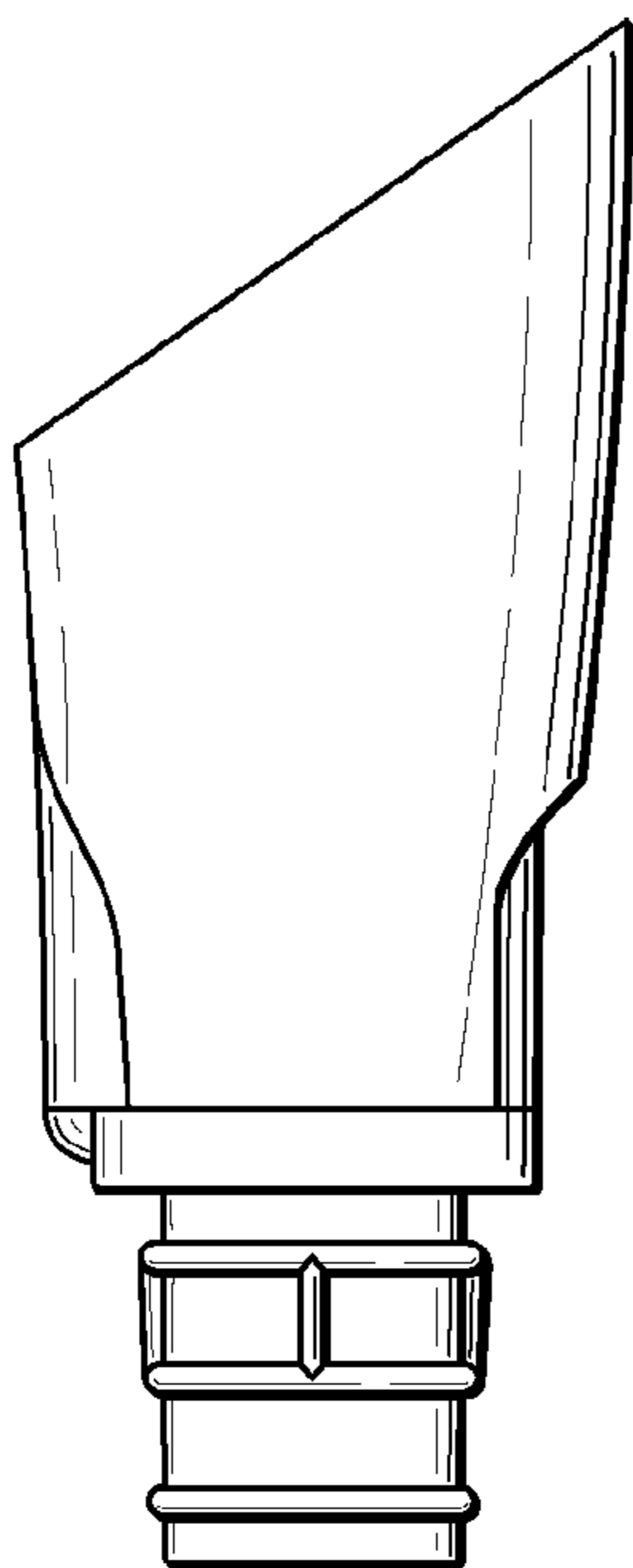

FIG. 3

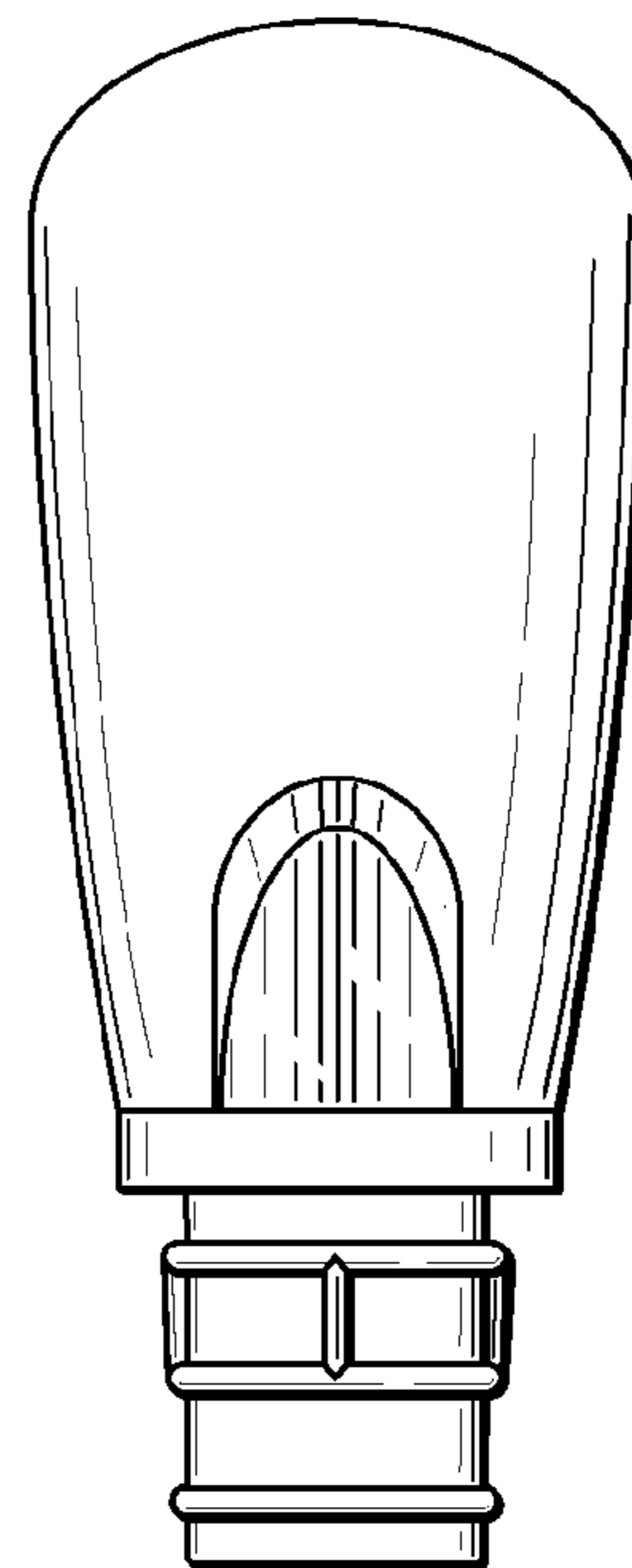

FIG. 4

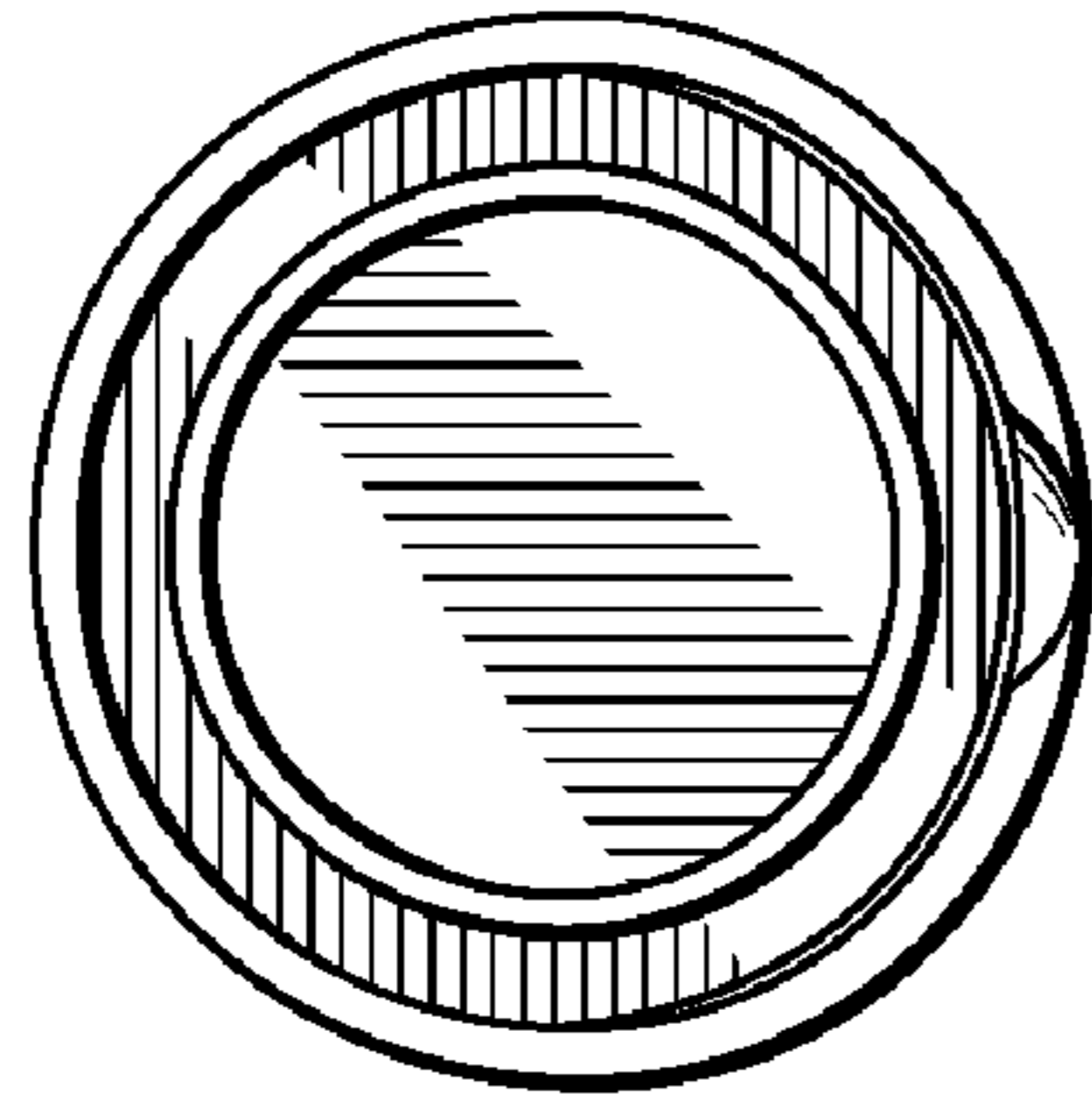

FIG. 5

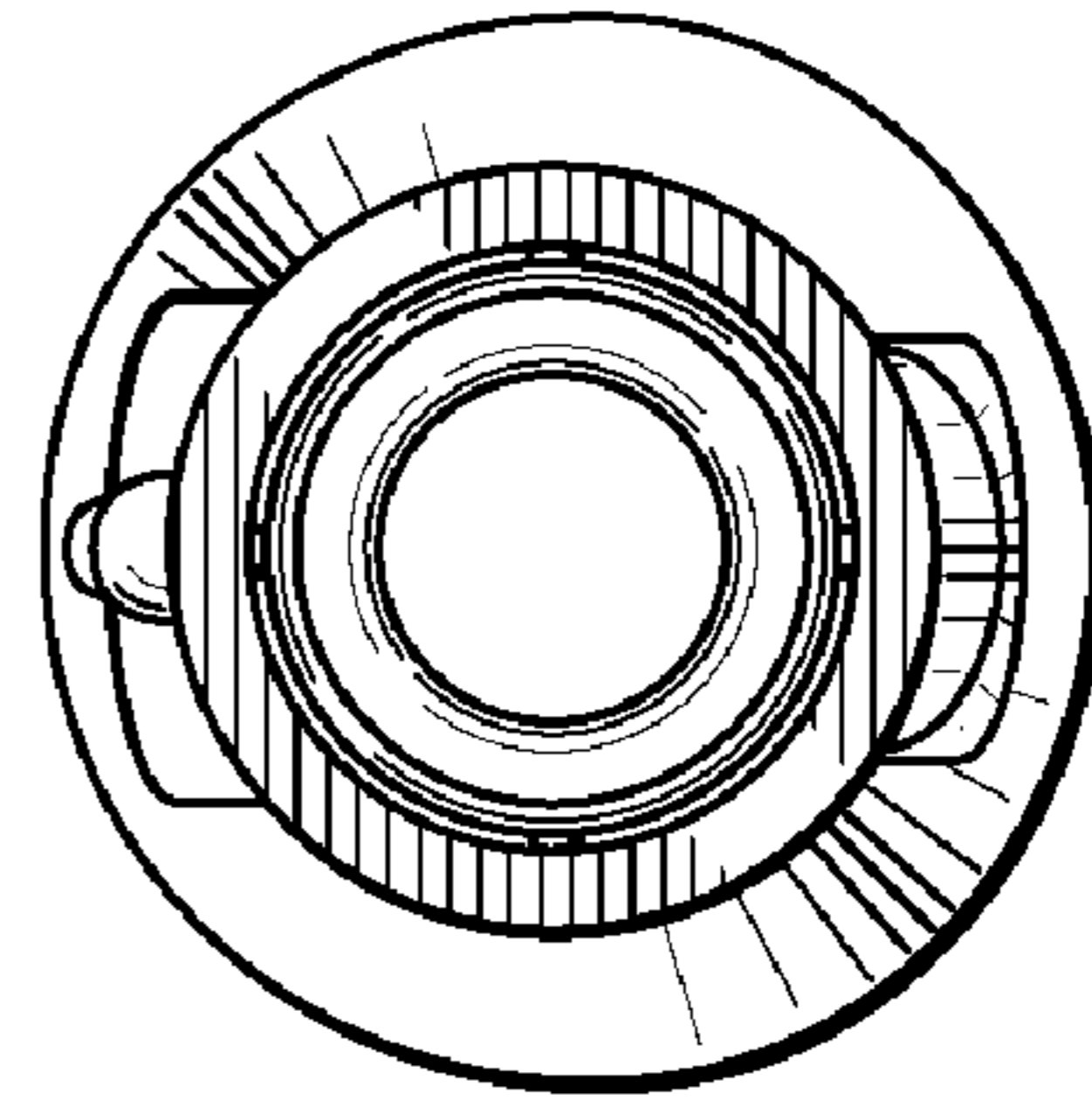

FIG. 6

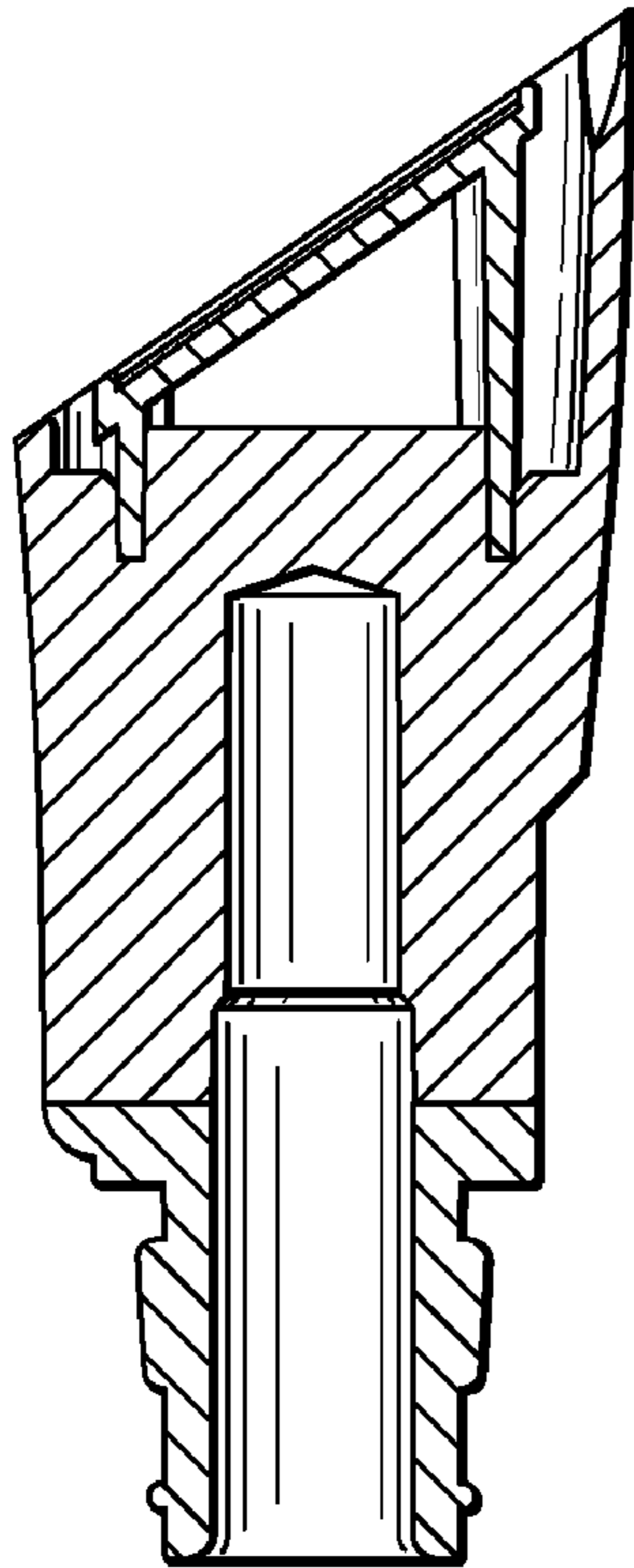

FIG. 7