



US00D633744S

(12) **United States Design Patent**
Williams

(10) **Patent No.:** **US D633,744 S**
(45) **Date of Patent:** **** Mar. 8, 2011**

(54) **HANGING DISK HOLDER**

(75) Inventor: **Sean Philip Williams**, Lyndhurst, OH
(US)

(73) Assignee: **Ideastream Consumer Products, LLC**,
Cleveland, OH (US)

(**) Term: **14 Years**

(21) Appl. No.: **29/346,603**

(22) Filed: **Nov. 3, 2009**

(51) **LOC (9) Cl.** **06-04**

(52) **U.S. Cl.** **D6/626**

(58) **Field of Classification Search** D6/626,
D6/628-629, 407-408; D19/75, 86; 206/307.1,
206/308.1, 309-310, 311-313; 312/902,
312/9.9, 9.48

See application file for complete search history.

(56) **References Cited**

U.S. PATENT DOCUMENTS

D298,265	S	*	10/1988	Snider et al.	D19/90
4,860,897	A		8/1989	Fowler et al.		
5,073,428	A	*	12/1991	Lancelot et al.	428/67
5,651,458	A		7/1997	Brosmith et al.		
5,699,905	A		12/1997	Hara		
5,813,525	A		9/1998	McQueeny		
D407,441	S	*	3/1999	Greenberg et al.	D19/90
5,947,301	A		9/1999	Kunz		

(Continued)

FOREIGN PATENT DOCUMENTS

DE	297 02 145	3/1997
----	------------	--------

OTHER PUBLICATIONS

Prototype Hanging Disk Holder shown before Nov. 3, 2008.

Primary Examiner — Elizabeth A Albert
Assistant Examiner — Kelley A Donnelly

(74) *Attorney, Agent, or Firm* — Calfee, Halter & Griswold
LLP

(57) **CLAIM**

I claim the ornamental design for a hanging disk holder, as
shown and described.

DESCRIPTION

FIG. 1 is a front/right/top perspective view of a first embodi-
ment of the hanging disk holder shown without the tab for
convenience;

FIG. 2 is a front elevational view thereof;

FIG. 3 is a rear elevational view thereof;

FIG. 4 is a top plan view thereof;

FIG. 5 is a bottom plan view thereof; and

FIG. 6 is a left side elevational view thereof, for which the
right side elevational view thereof would be a mirror image
thereof.

FIG. 7 is a front/left/top perspective view of a second embodi-
ment, further including a tab in the upper left pocket at a first
location;

FIG. 8 is a front elevational view of the hanging disk holder
and tab of FIG. 7 with the tab at the first location;

FIG. 9 is a rear elevational view of the hanging disk holder
and tab of FIG. 7 with the tab at the first location;

FIG. 10 is a front/left/top perspective view thereof, with the
tab in the upper left pocket at a second location;

FIG. 11 is a front elevational view of the hanging disk holder
and tab of FIG. 10 with the tab at the second location;

FIG. 12 is a front/left/top perspective view thereof, with the
tab in the upper right pocket at a third location;

FIG. 13 is a front elevational view of the hanging disk holder
and tab of FIG. 12 with the tab at the third location;

FIG. 14 is a front/left/top perspective view thereof, with the
tab in the upper right pocket at a fourth location; and,

FIG. 15 is a front elevational view of the hanging disk holder
and tab of FIG. 14 with the tab at the fourth location.

Broken lines are directed to environment and are for illustra-
tive purposes only; the broken lines form no part of the
claimed design.

1 Claim, 13 Drawing Sheets

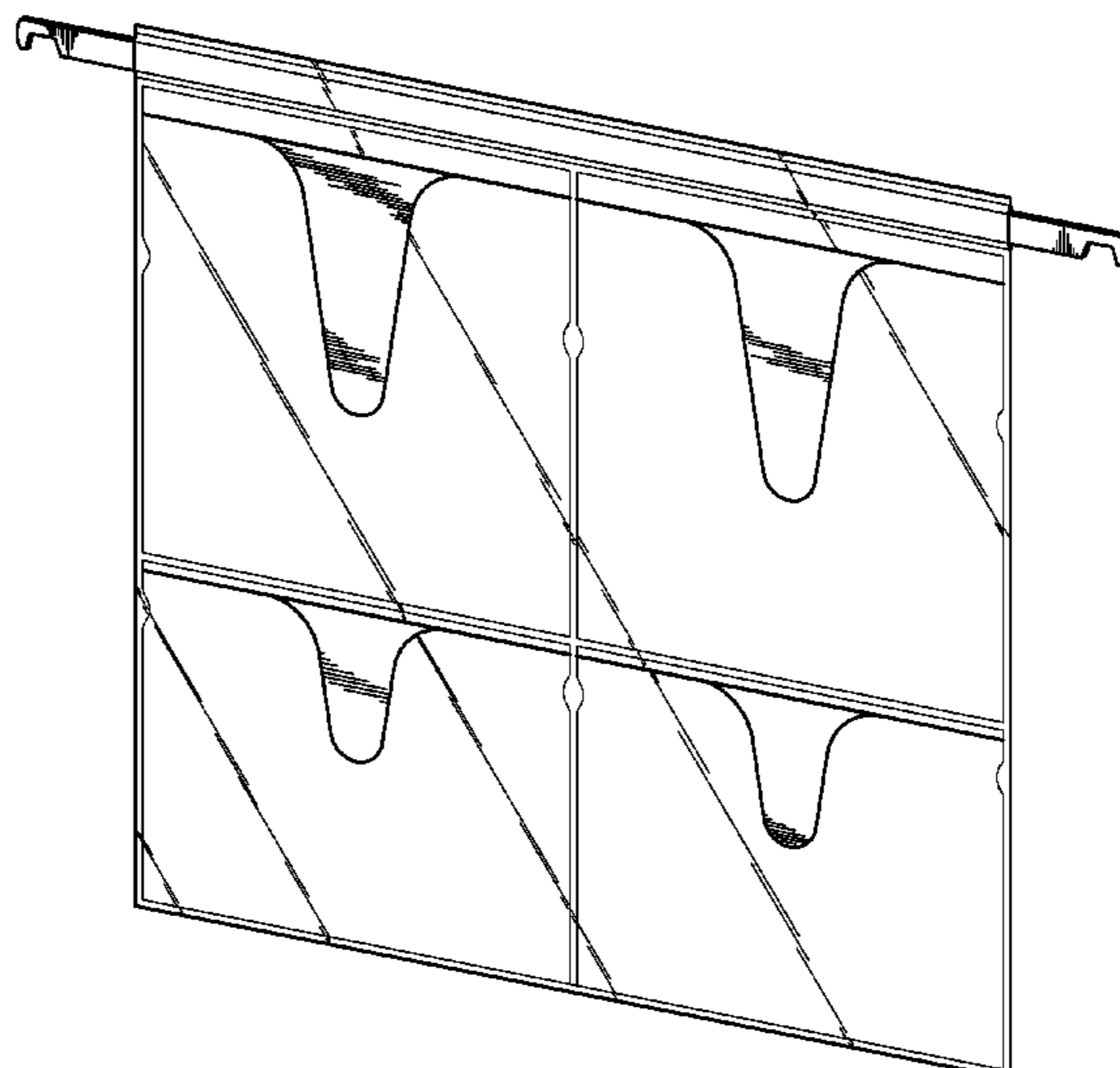

US D633,744 S

Page 2

U.S. PATENT DOCUMENTS

D419,358 S *	1/2000	Marcon	D6/626	D493,325 S *	7/2004	Hassett	D6/626
D426,099 S *	6/2000	Udwin et al.	D6/626	6,830,156 B2	12/2004	MacKelvie	
6,073,765 A	6/2000	Liu		D505,809 S *	6/2005	Cassidy et al.	D6/491
D485,112 S *	1/2004	Ballantine et al.	D6/626	D582,192 S *	12/2008	Pan	D6/626
D485,465 S	1/2004	Hassett		2006/0124480 A1	6/2006	Menard	

* cited by examiner

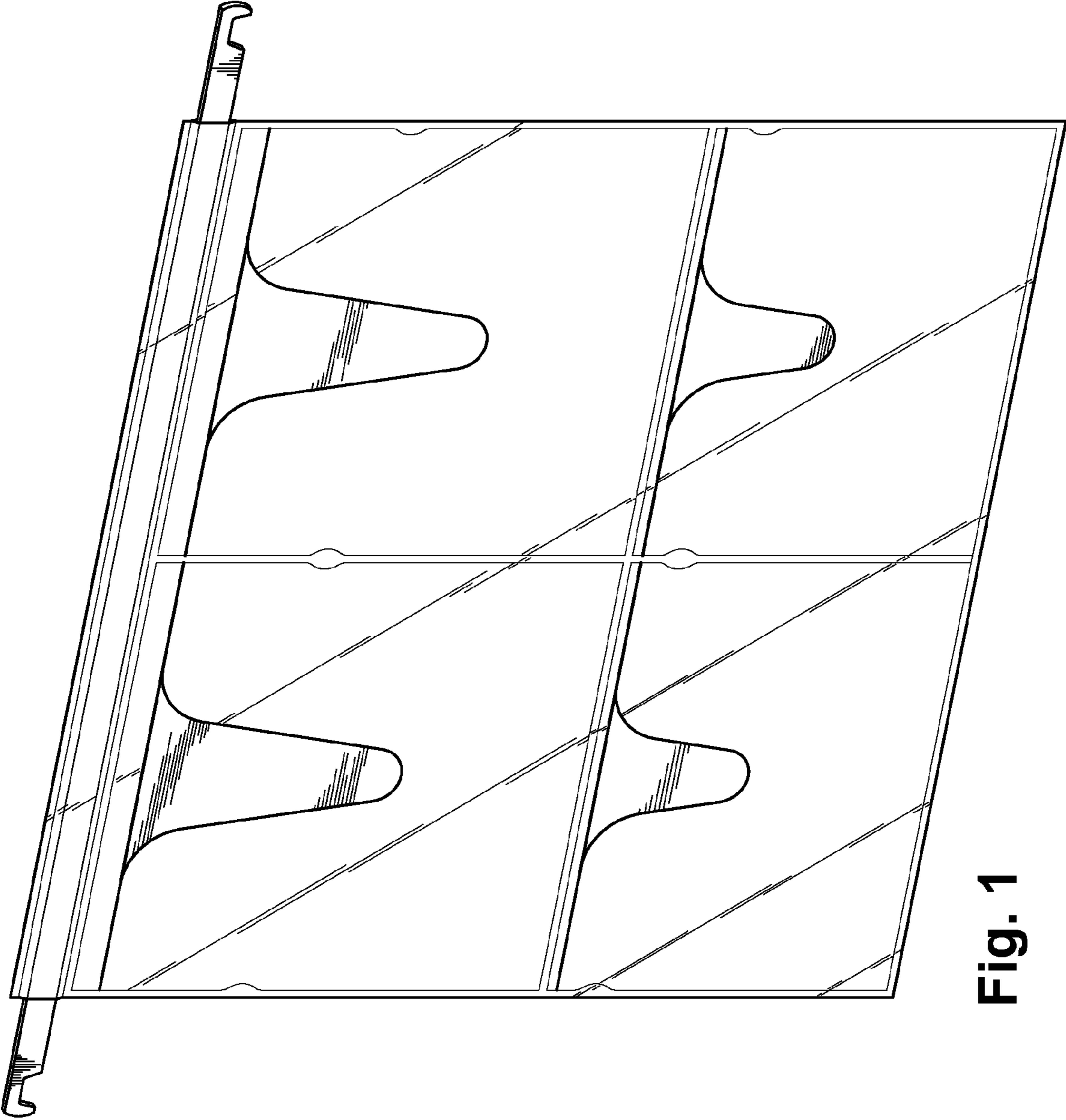

Fig. 1

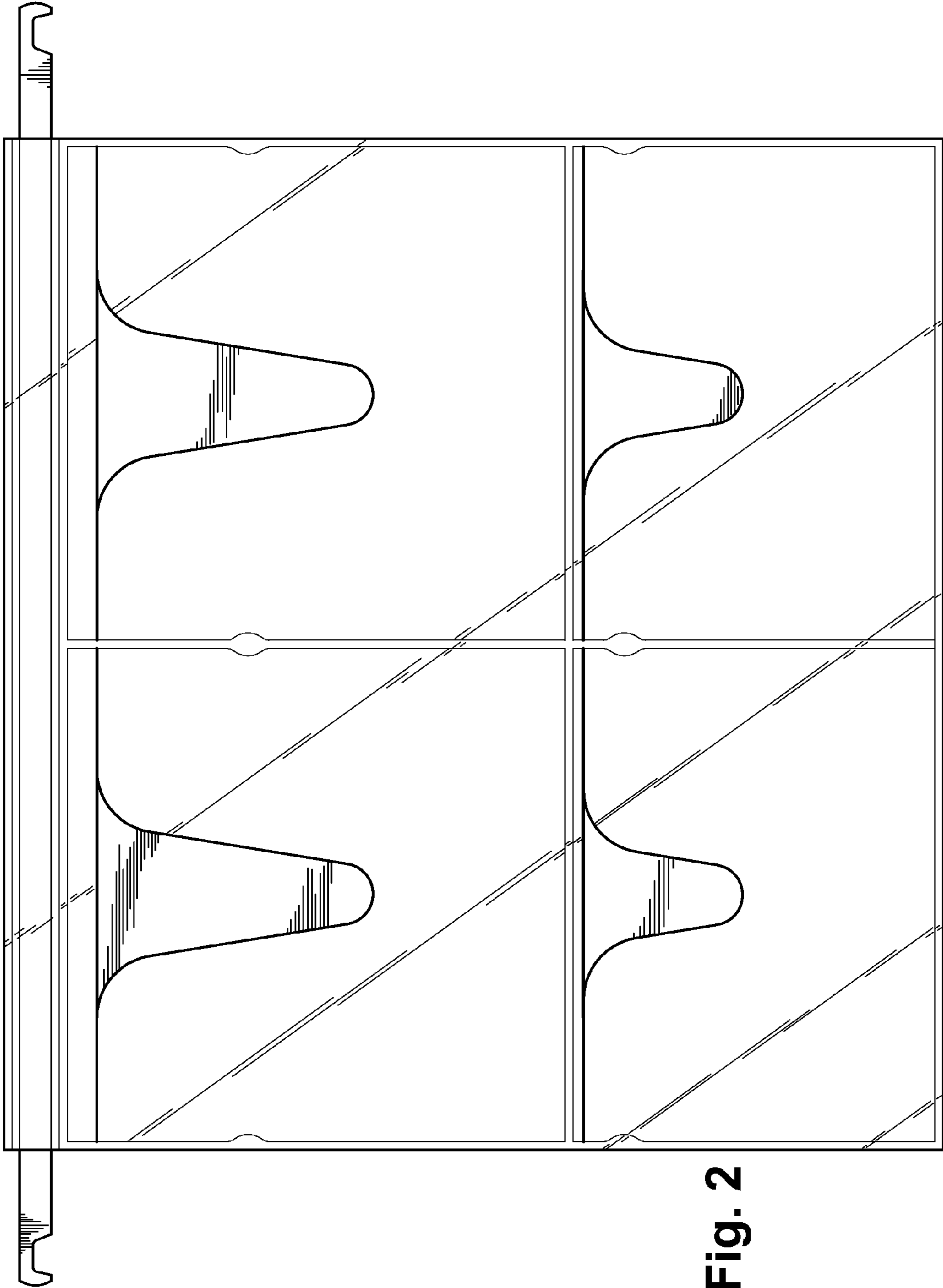

Fig. 2

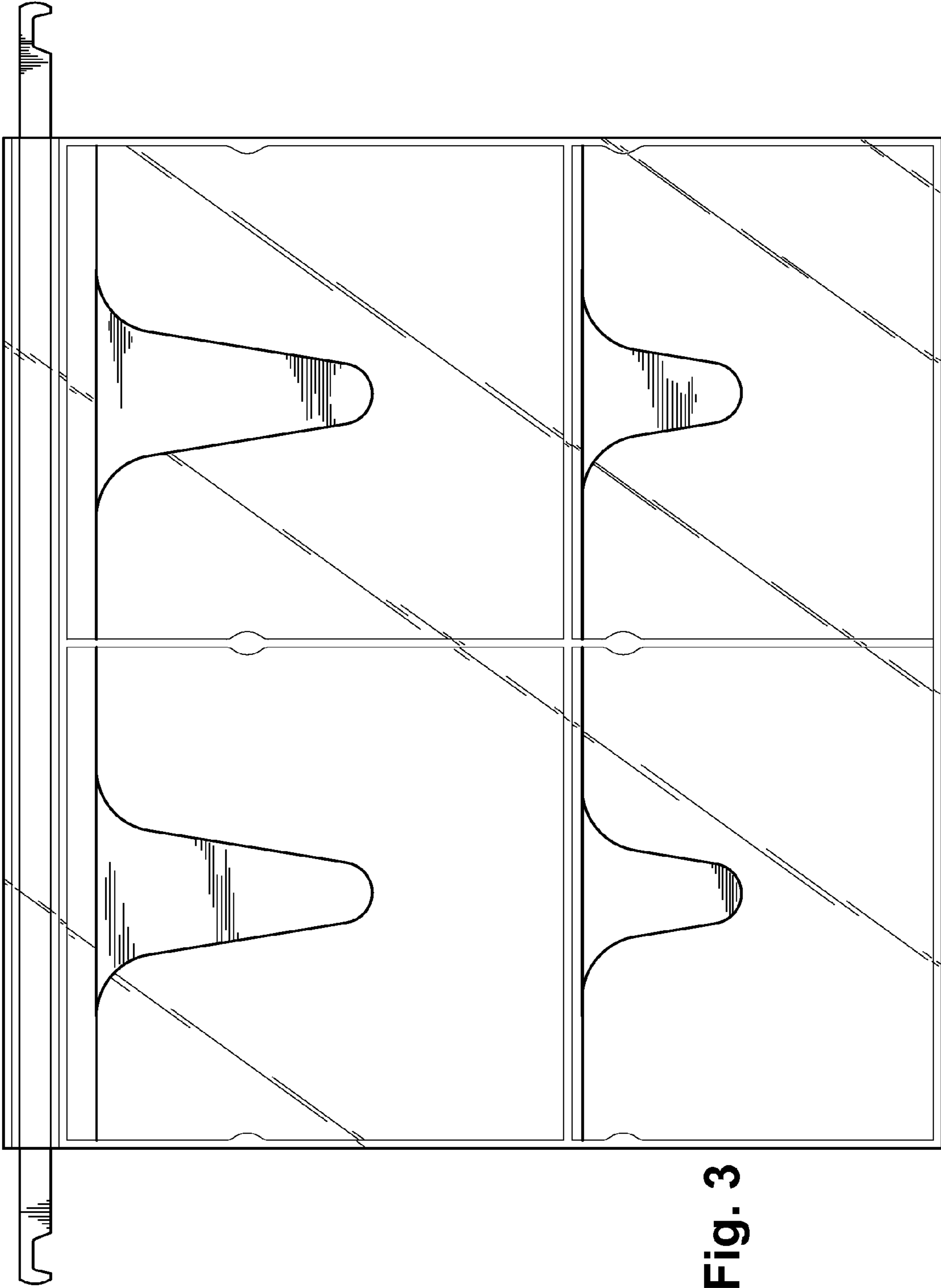

Fig. 3



Fig. 4



Fig. 5

Fig. 6

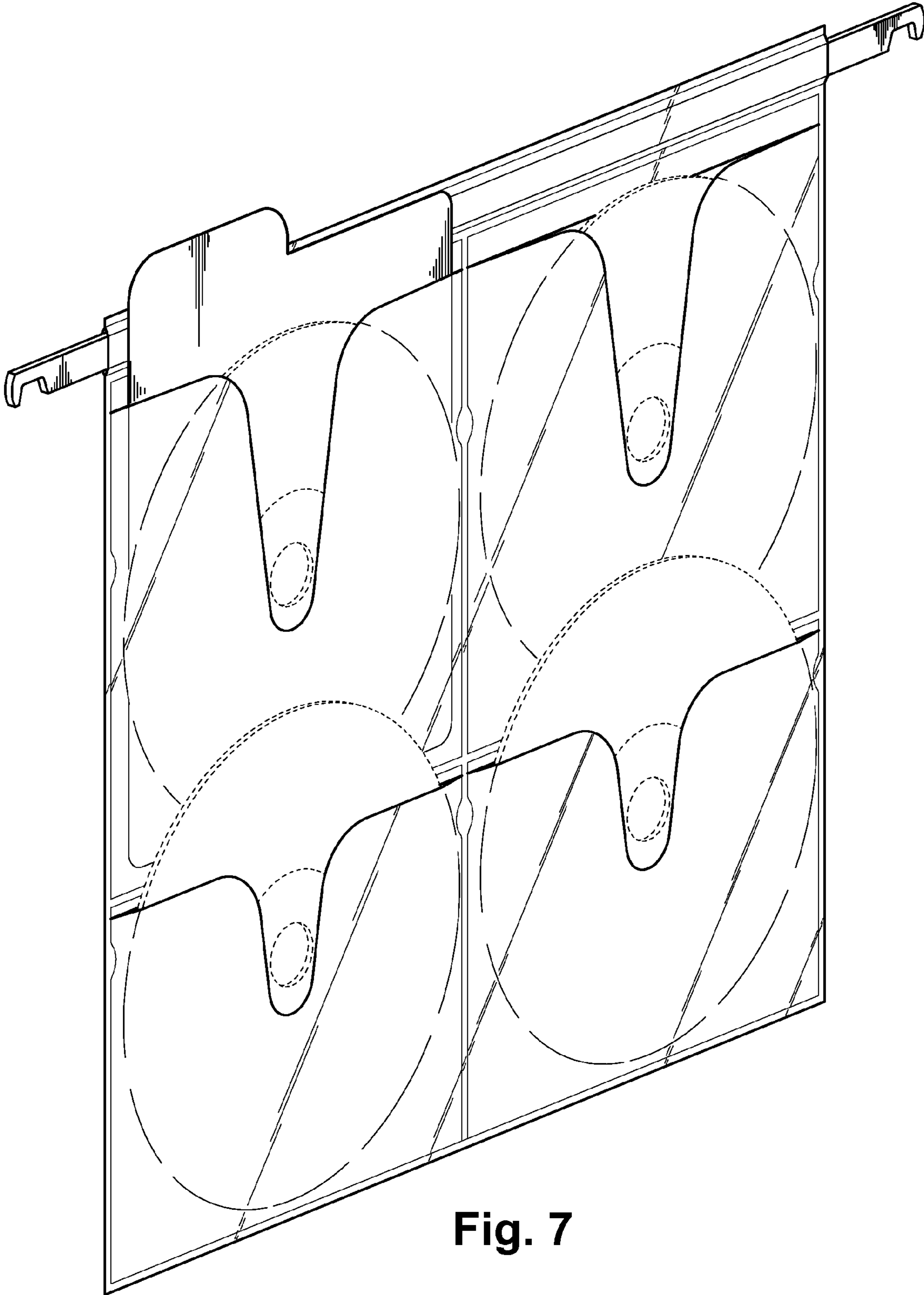

Fig. 7

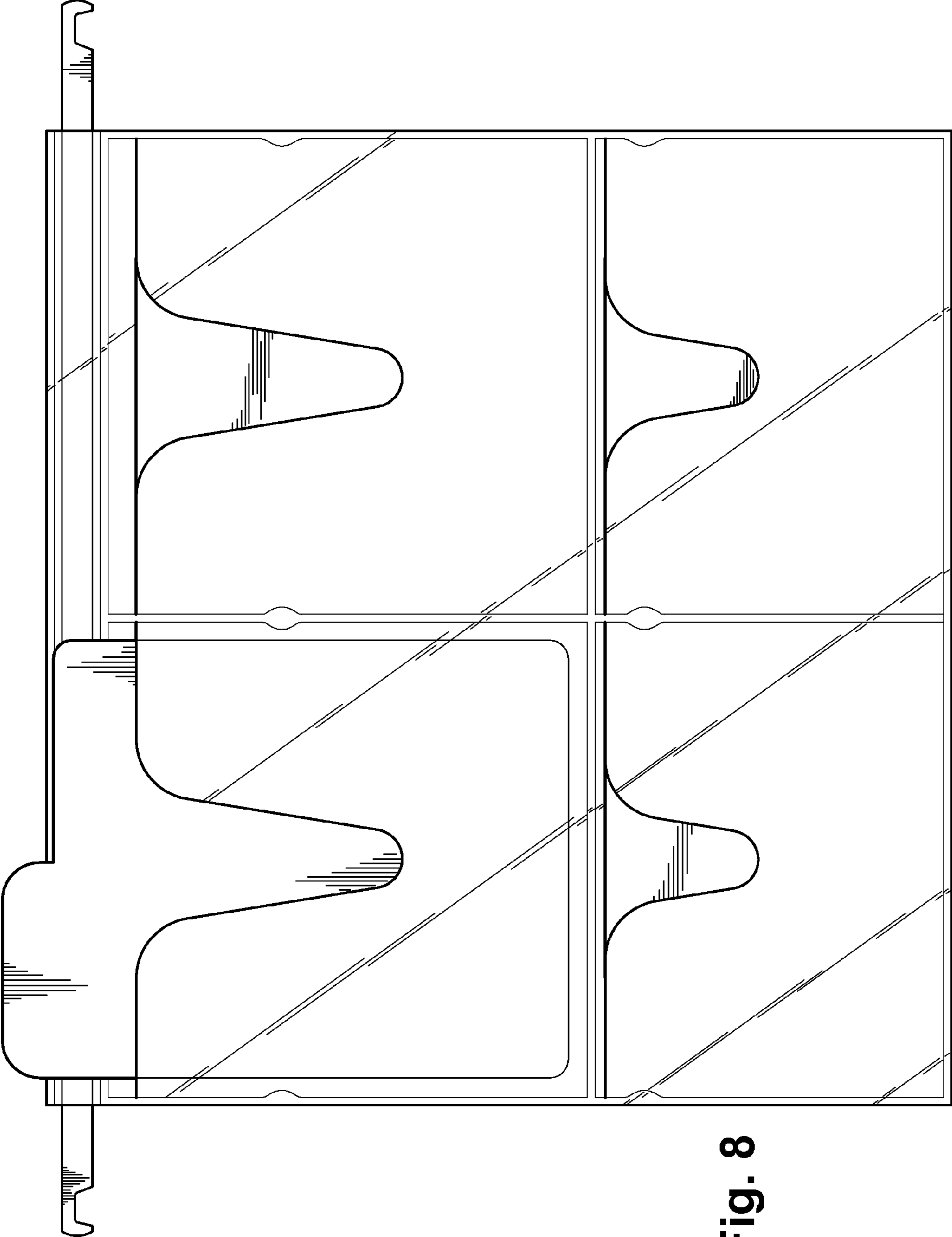

Fig. 8

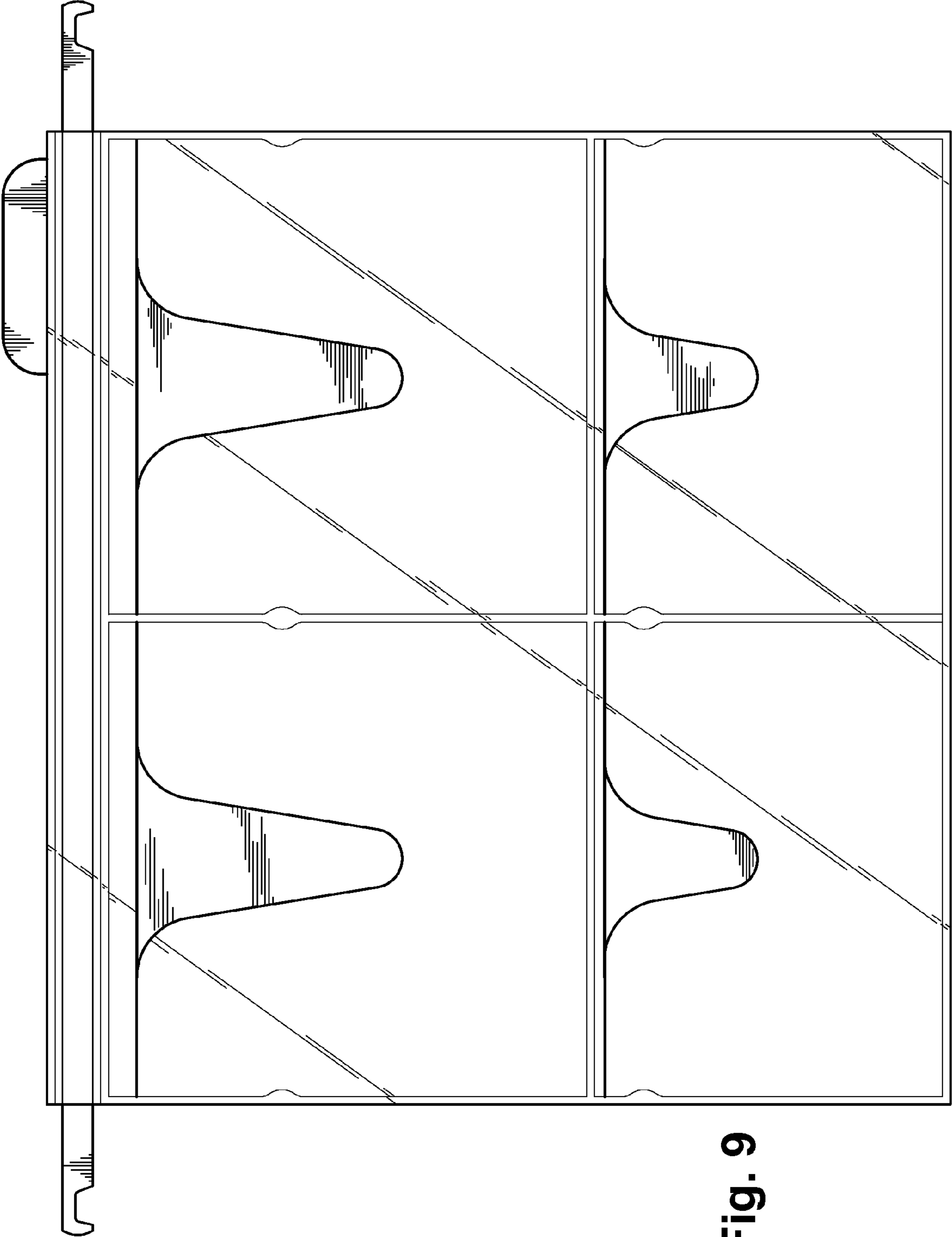

Fig. 9

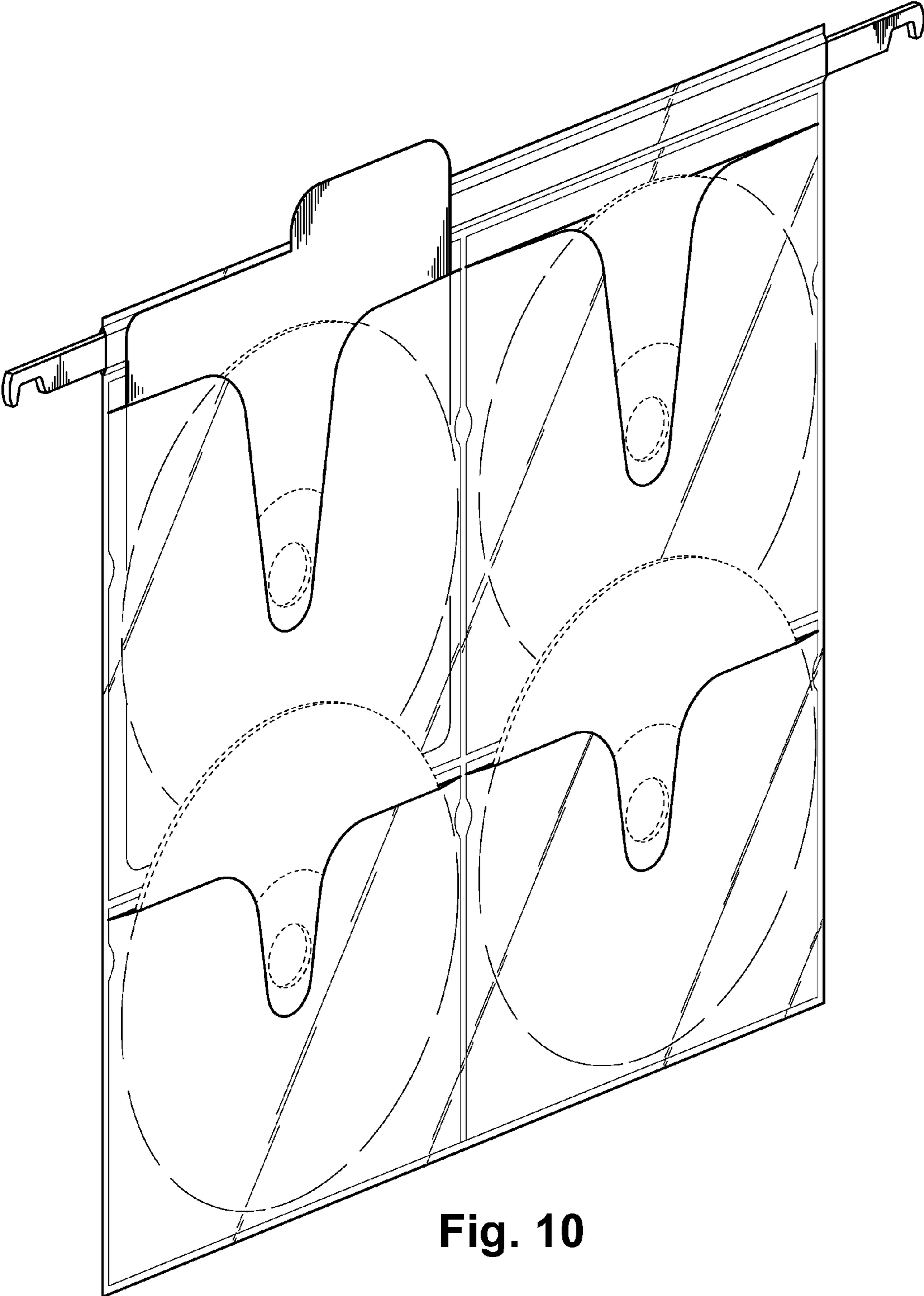

Fig. 10

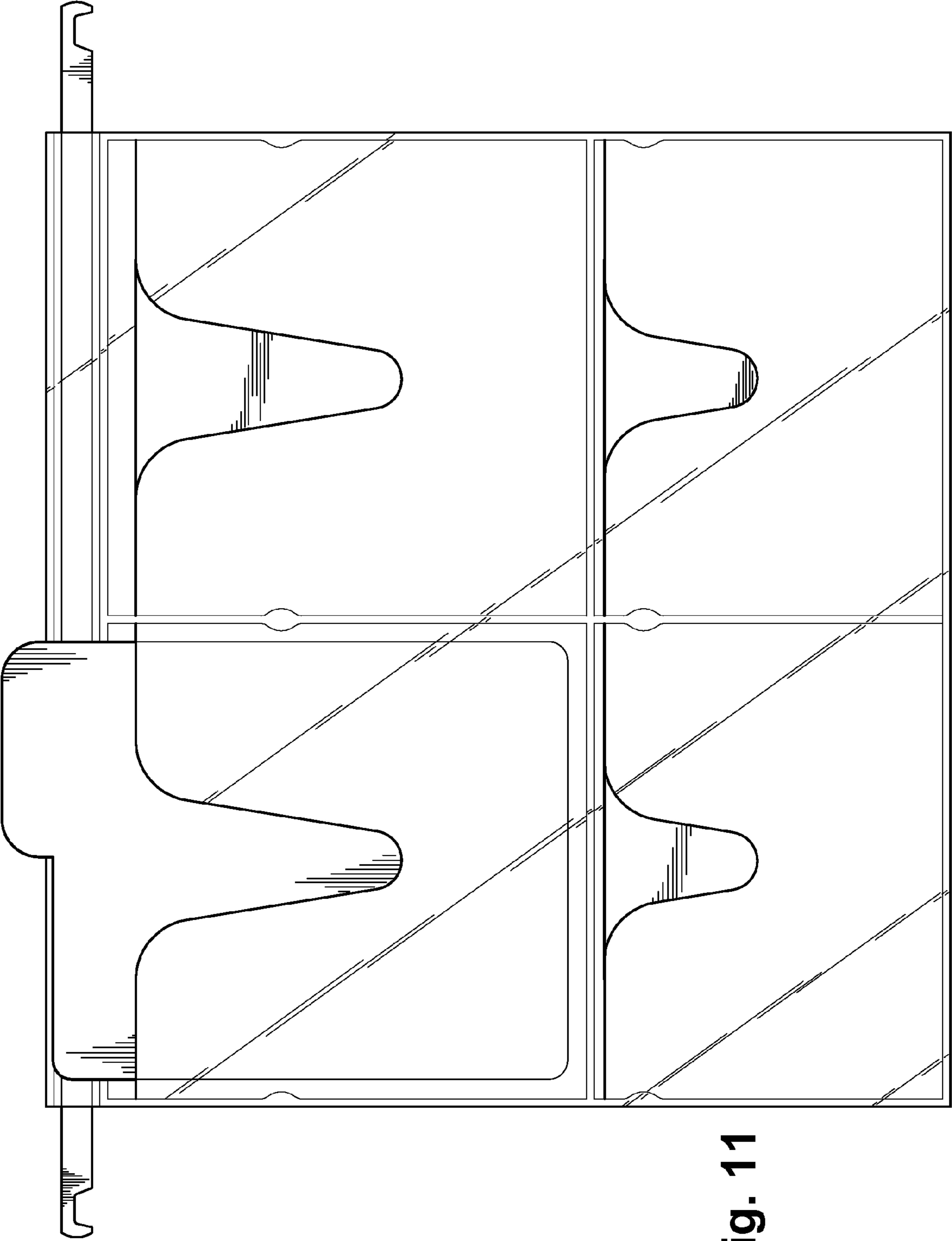

Fig. 11

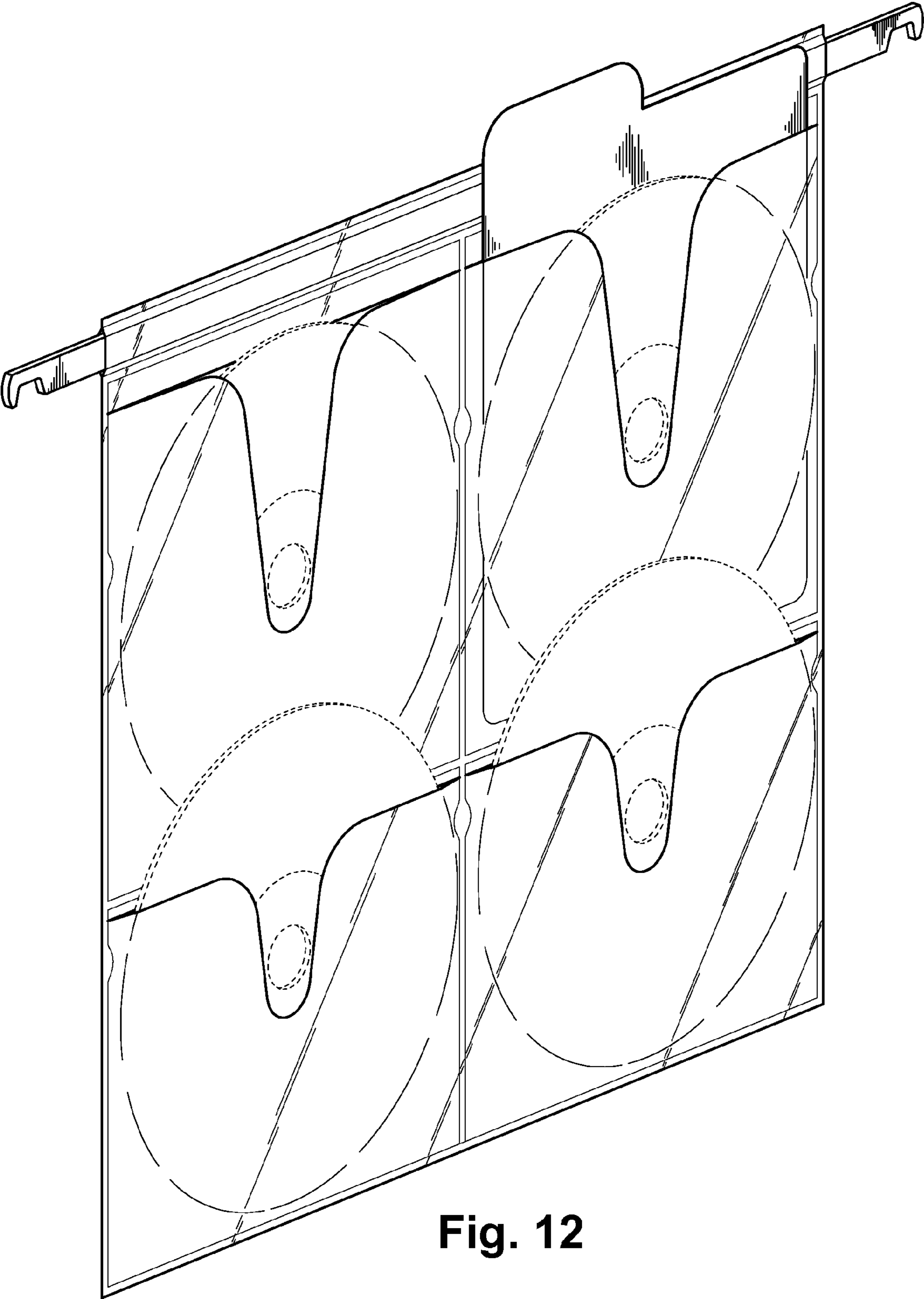

Fig. 12

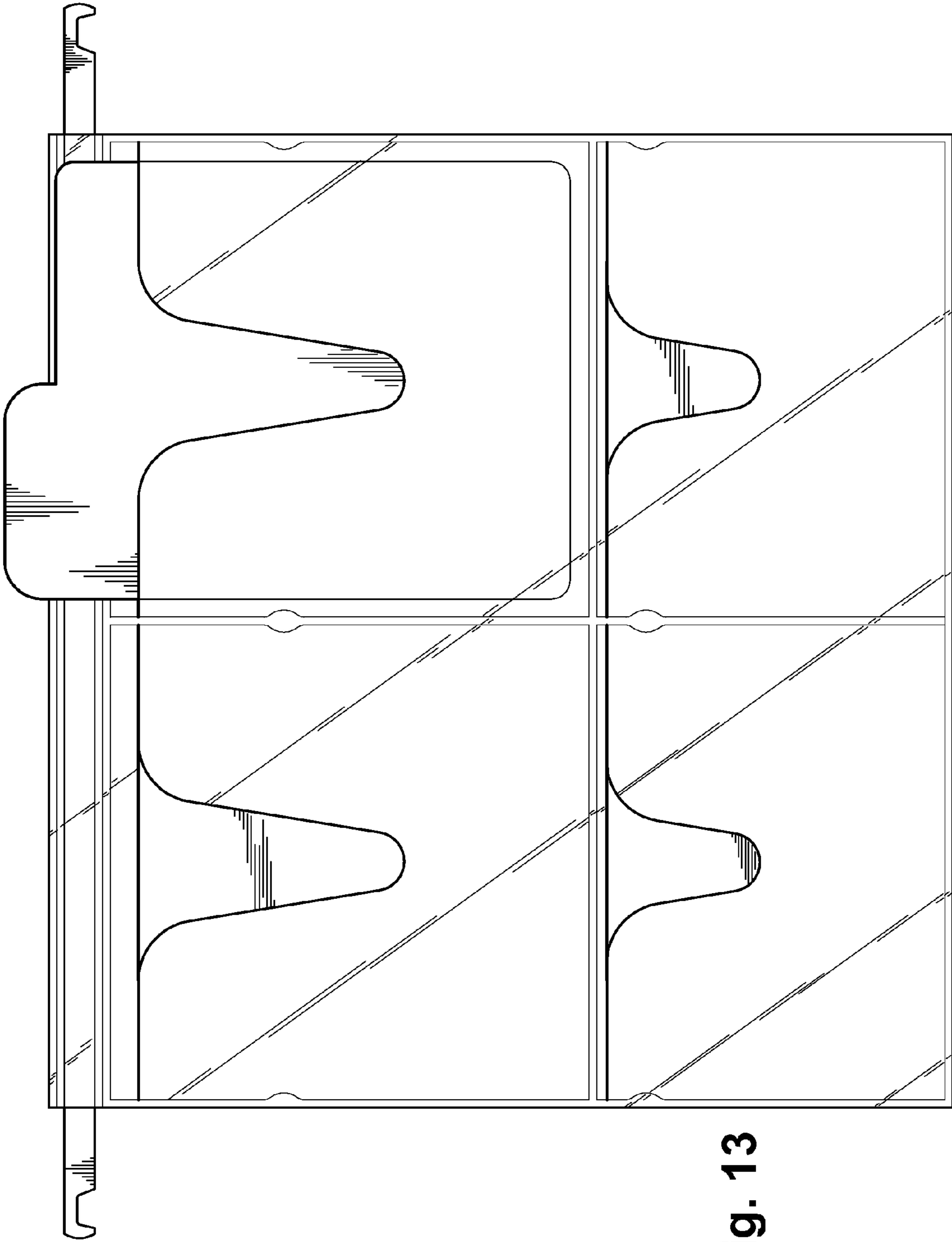

Fig. 13

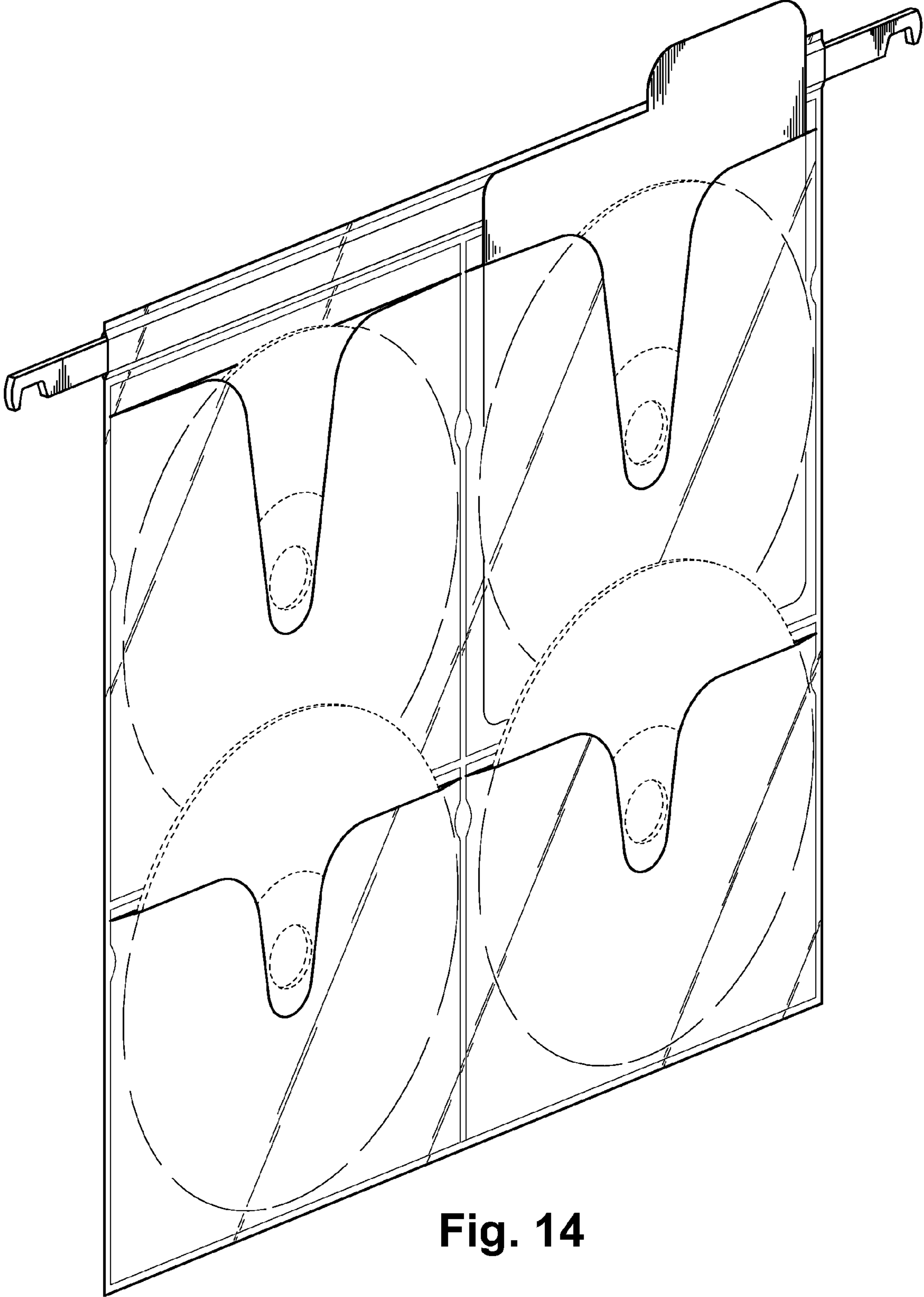

Fig. 14

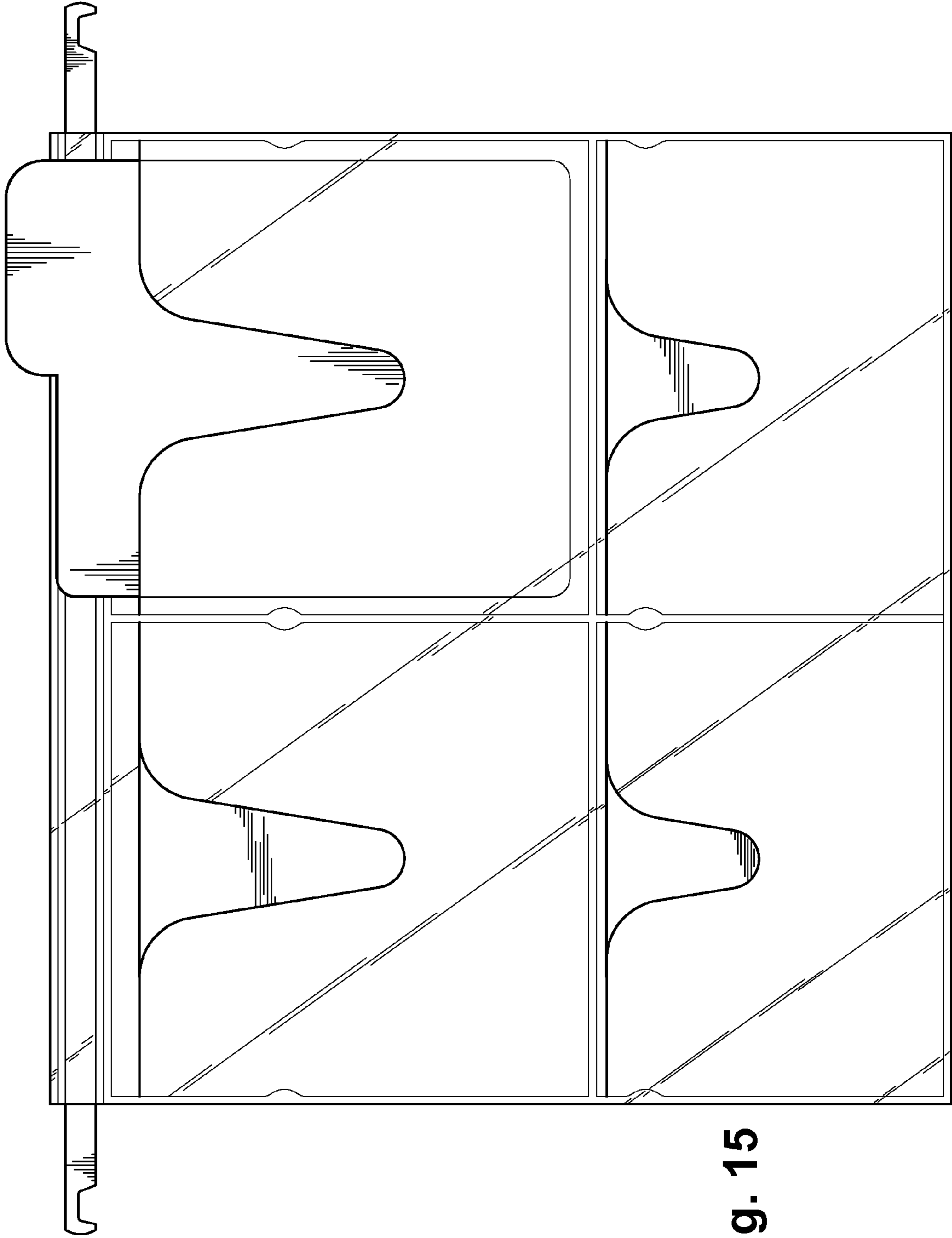

Fig. 15