



US00D633609S

(12) **United States Design Patent**
Shapiro

(10) **Patent No.:** **US D633,609 S**

(45) **Date of Patent:** **** Mar. 1, 2011**

(54) **BODY FOR A PORTABLE HEATER**

(75) Inventor: **Barry Shapiro**, Doylestown, PA (US)

(73) Assignee: **Lasko Holdings, Inc.**, Wilmington, DE (US)

(**) Term: **14 Years**

(21) Appl. No.: **29/349,092**

(22) Filed: **Mar. 8, 2010**

(51) **LOC (9) Cl.** **23-03**

(52) **U.S. Cl.** **D23/314; D23/335; D23/378; D23/332**

(58) **Field of Classification Search** D23/317, D23/314, 332, 333, 334, 335, 337, 342, 351, D23/355, 378, 370, 381, 364, 336, 341; 416/244 R, 416/247 R, 53.1-53.3; 392/365, 367
See application file for complete search history.

(56) **References Cited**

U.S. PATENT DOCUMENTS

D507,340 S	*	7/2005	Shapiro	D23/335
D562,952 S	*	2/2008	Lewis	D23/341
D562,953 S	*	2/2008	Lewis	D23/341
D567,344 S	*	4/2008	Gao	D23/317
D572,350 S	*	7/2008	Shapiro	D23/317
D578,630 S	*	10/2008	Shapiro	D23/335
D604,816 S	*	11/2009	Cepress	D23/332

D604,817 S	*	11/2009	Lee	D23/332
D604,819 S	*	11/2009	Krapfl	D23/332
D605,264 S	*	12/2009	Cepress	D23/332
D606,182 S	*	12/2009	Lee	D23/314

* cited by examiner

Primary Examiner—T. Chase Nelson

Assistant Examiner—Ania K Dworzecka

(74) *Attorney, Agent, or Firm*—Martin Fruitman

(57) **CLAIM**

The ornamental design for a body for a portable heater, as shown and described.

DESCRIPTION

FIG. 1 is a right side front perspective view of a body for a portable heater showing my new design;

FIG. 2 is a right side rear perspective view thereof;

FIG. 3 is a front elevation view thereof;

FIG. 4 is a right side elevation view thereof;

FIG. 5 is a left side elevation view thereof;

FIG. 6 is a rear elevation view thereof; and,

FIG. 7 is a top plan view thereof.

The broken line showing of front grill, top controls and rear grill in FIGS. 1-7 is for illustrative purposes only and forms no part of the claimed design.

1 Claim, 7 Drawing Sheets

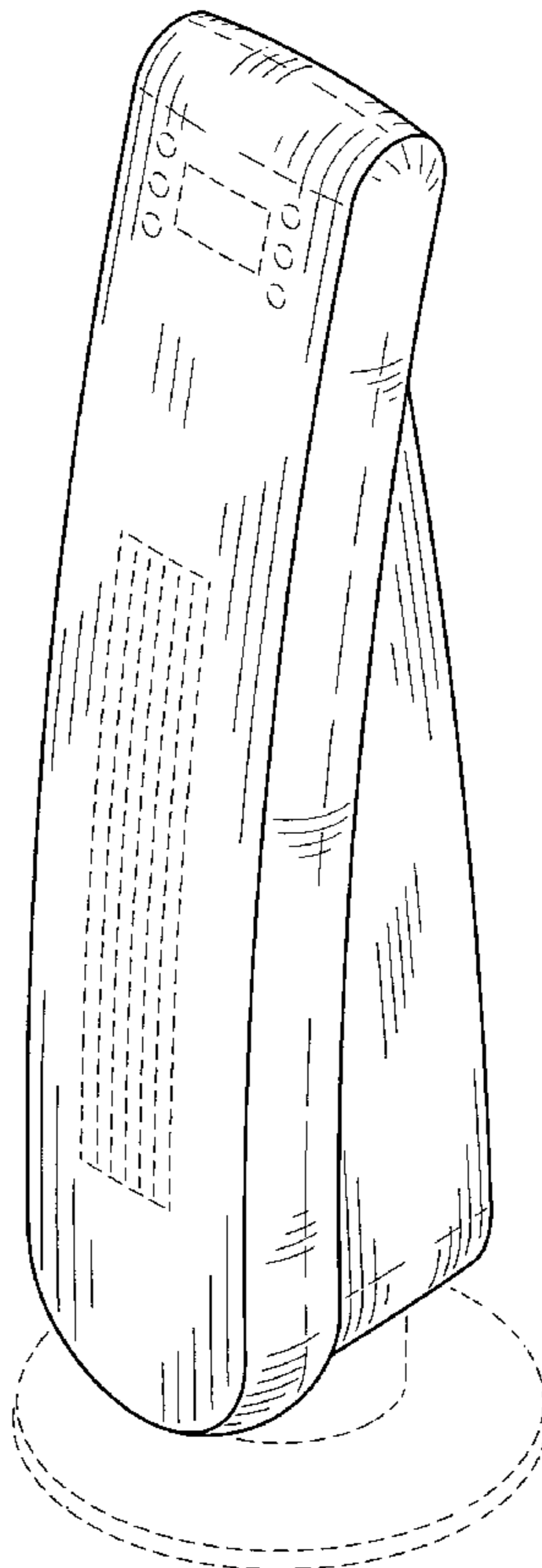

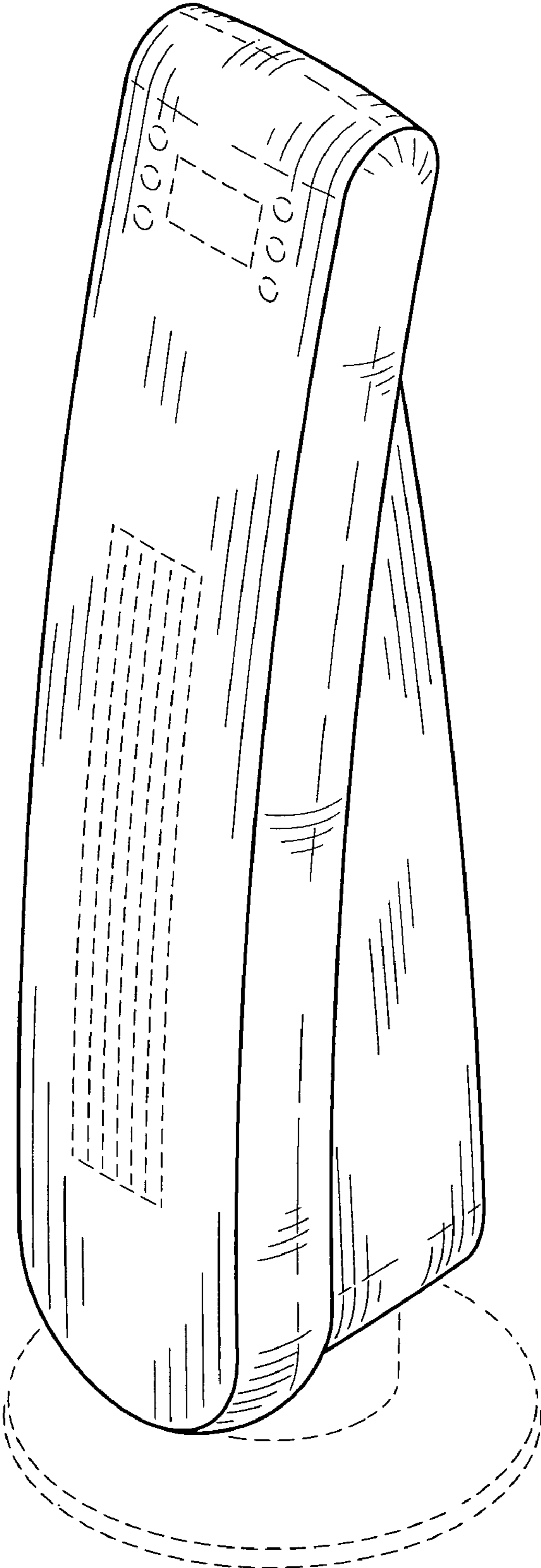

FIG. 1

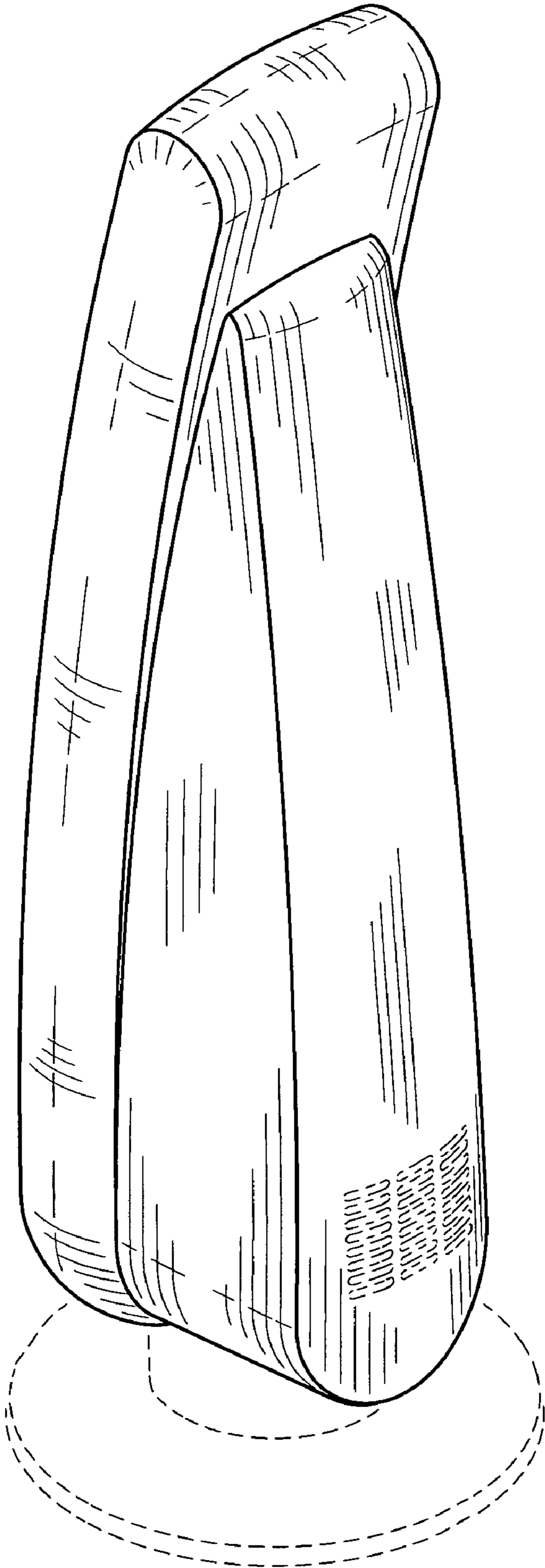

FIG. 2

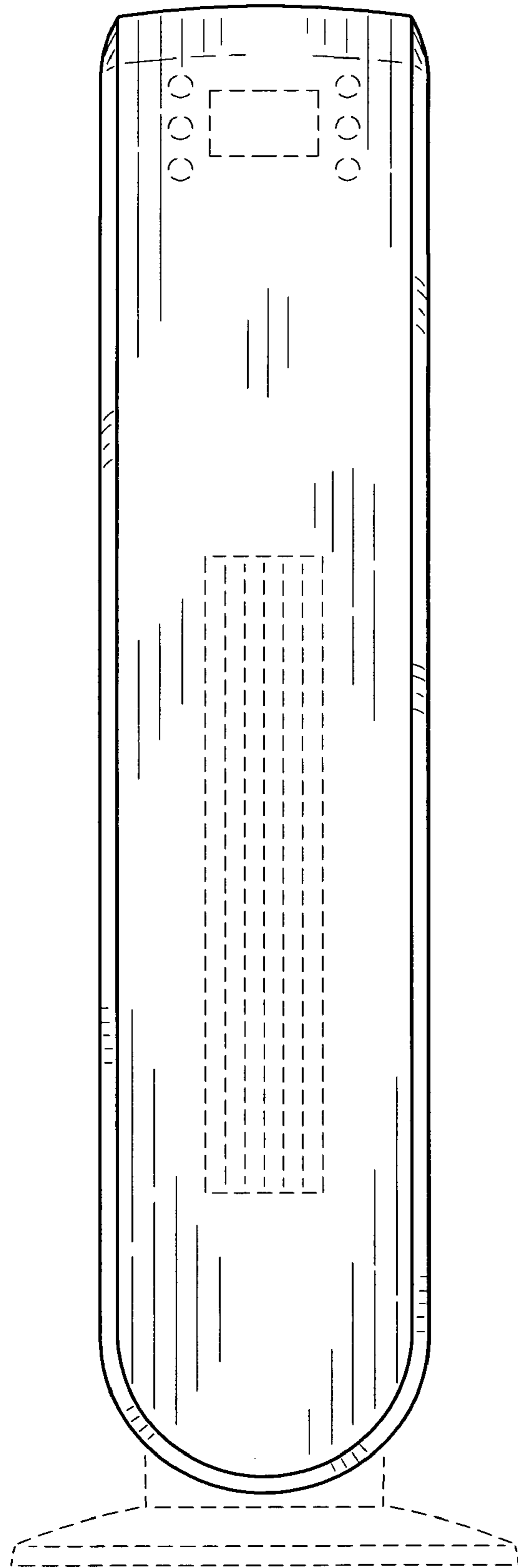

FIG. 3

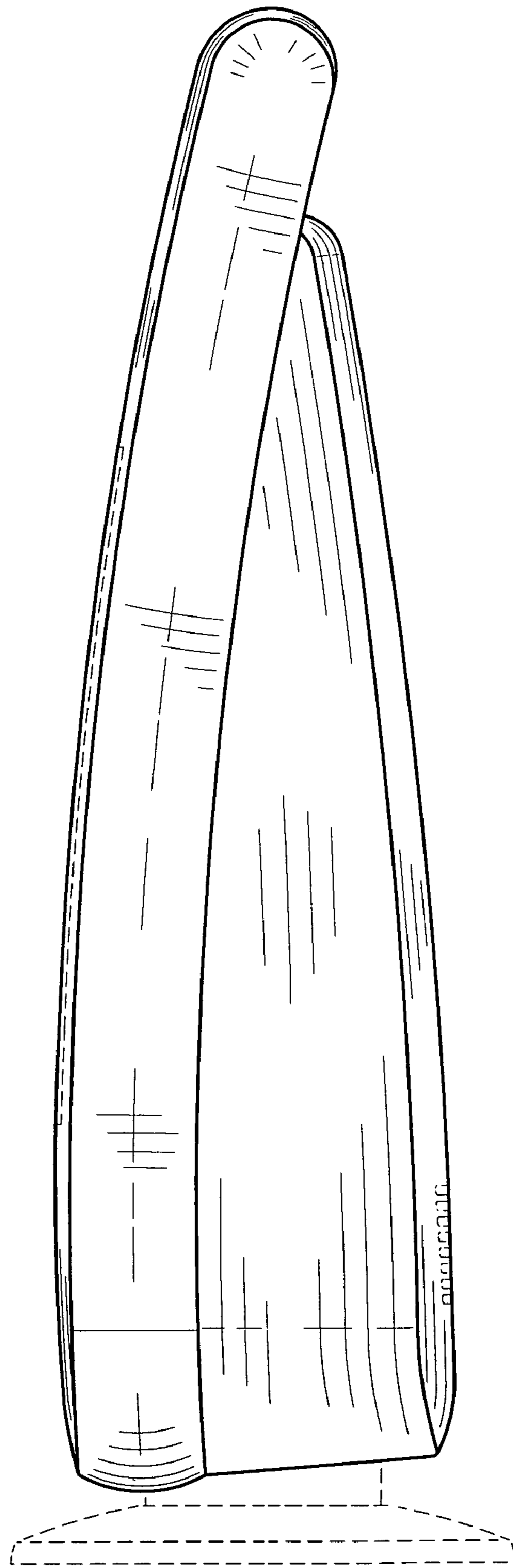

FIG. 4

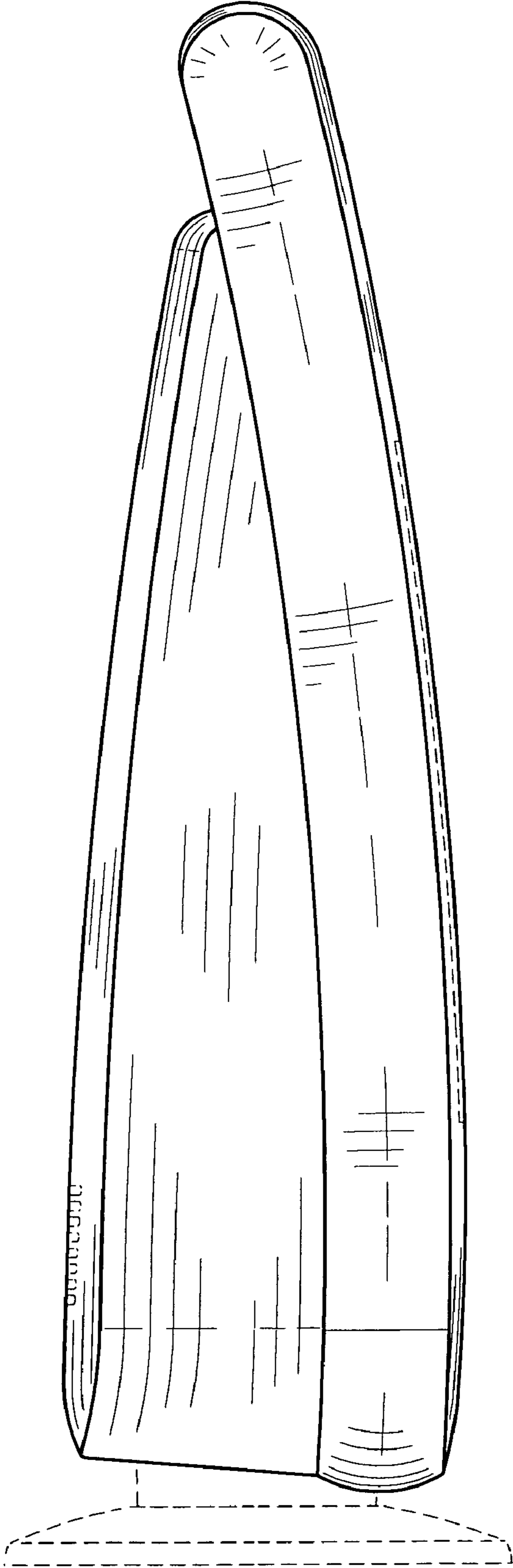

FIG. 5

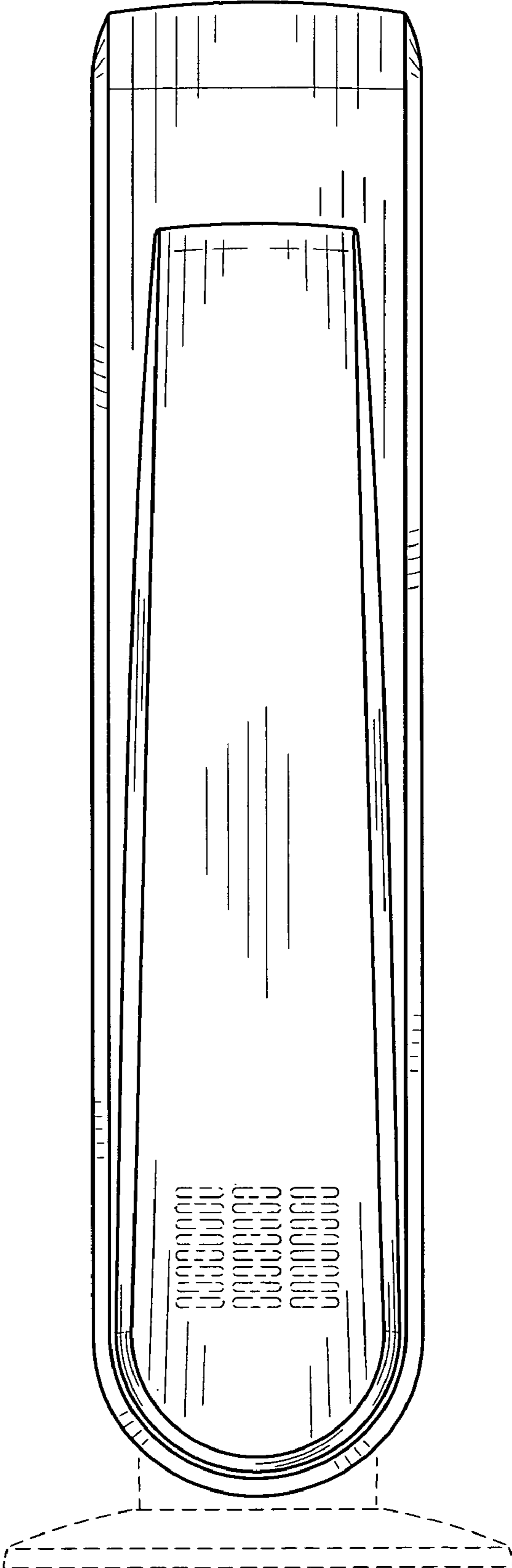

FIG. 6

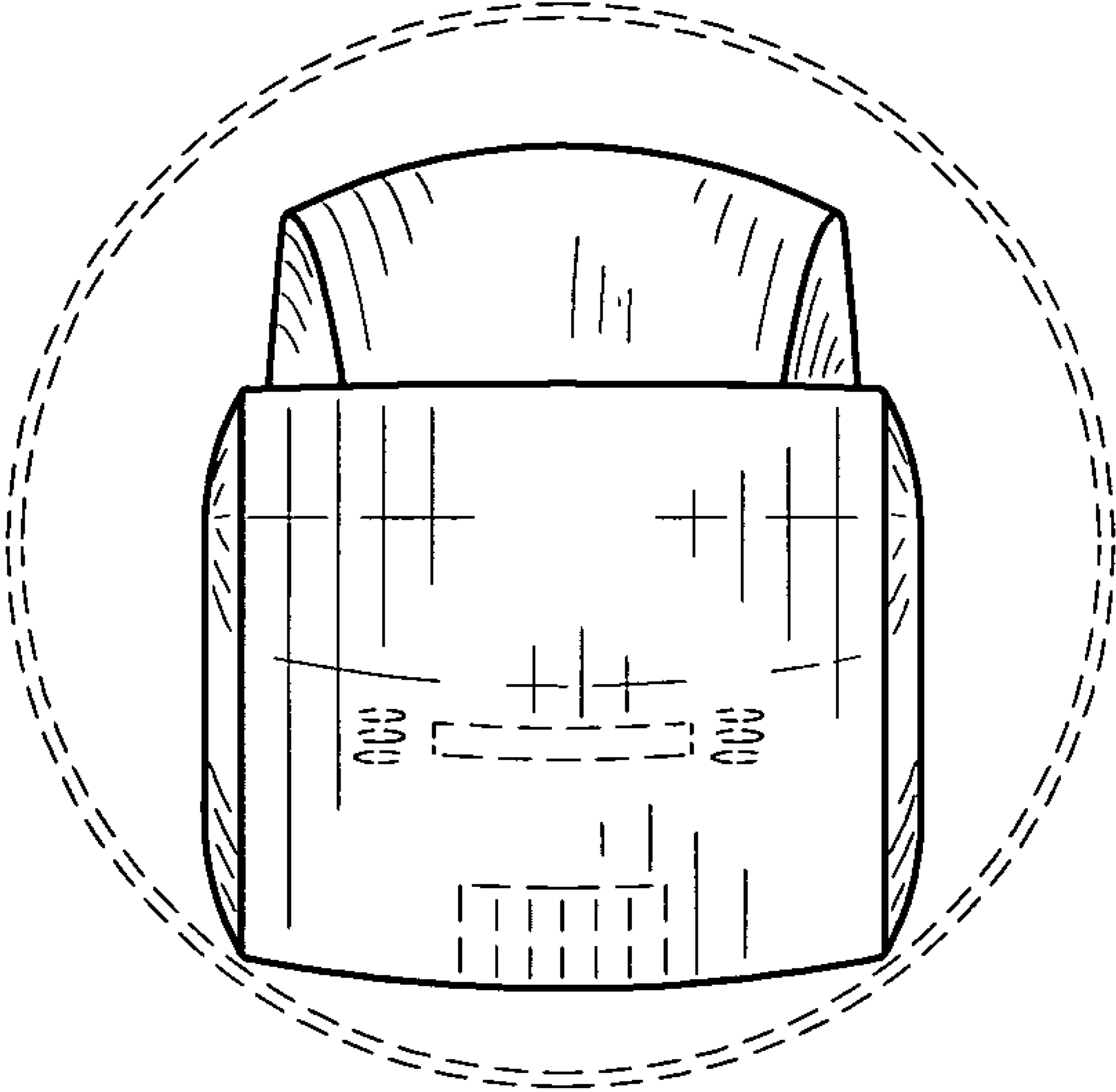

FIG. 7