



US00D633588S

(12) **United States Design Patent**
McCrimmon

(10) **Patent No.:** **US D633,588 S**
(45) **Date of Patent:** **** Mar. 1, 2011**

(54) **GOLF TEE SHARPENER AND DIVOT REPAIR DEVICE**

D477,377 S * 7/2003 D'Aguanno D21/793
D603,925 S * 11/2009 Hafdal D21/793

(76) Inventor: **James McCrimmon**, Vegreville (CA)

* cited by examiner

(**) Term: **14 Years**

Primary Examiner—Mitchell I Siegel

(21) Appl. No.: **29/355,589**

(74) *Attorney, Agent, or Firm*—Marsh Fischmann & Breyfogle LLP

(22) Filed: **Feb. 10, 2010**

(57) **CLAIM**

(51) **LOC (9) Cl.** **21-02**

The industrial design for the golf tee sharpener and divot repair device, as shown and described.

(52) **U.S. Cl.** **D21/793; D19/73**

(58) **Field of Classification Search** D21/789,
D21/793, 717-719; D8/91; D19/73; 473/286,
473/408; 30/241

DESCRIPTION

See application file for complete search history.

FIG. 1 is a first perspective view of the device;

FIG. 2 is a second perspective view of the device;

FIG. 3 is a top view of the device;

FIG. 4 is a right side view of the device;

FIG. 5 is a front view of the device; and,

FIG. 6 is a rear view of the device.

(56) **References Cited**

U.S. PATENT DOCUMENTS

3,911,577	A	*	10/1975	Nickel	30/241
D245,476	S	*	8/1977	Cammarota	D8/91
D336,124	S	*	6/1993	Ordlock	D21/793
D345,776	S	*	4/1994	Williams	D21/793
D348,402	S	*	7/1994	McDonald	D10/31
D365,366	S	*	12/1995	Cerrato	D19/73
D425,164	S	*	5/2000	Tate	D21/793
D442,249	S	*	5/2001	Fazekas	D21/793

The bottom view is omitted from the Drawings as the device has a bottom that is flat and that is devoid of surface ornamentation. The left side view is omitted from the Drawings as it is a mirror image of the right side view of the device.

1 Claim, 6 Drawing Sheets

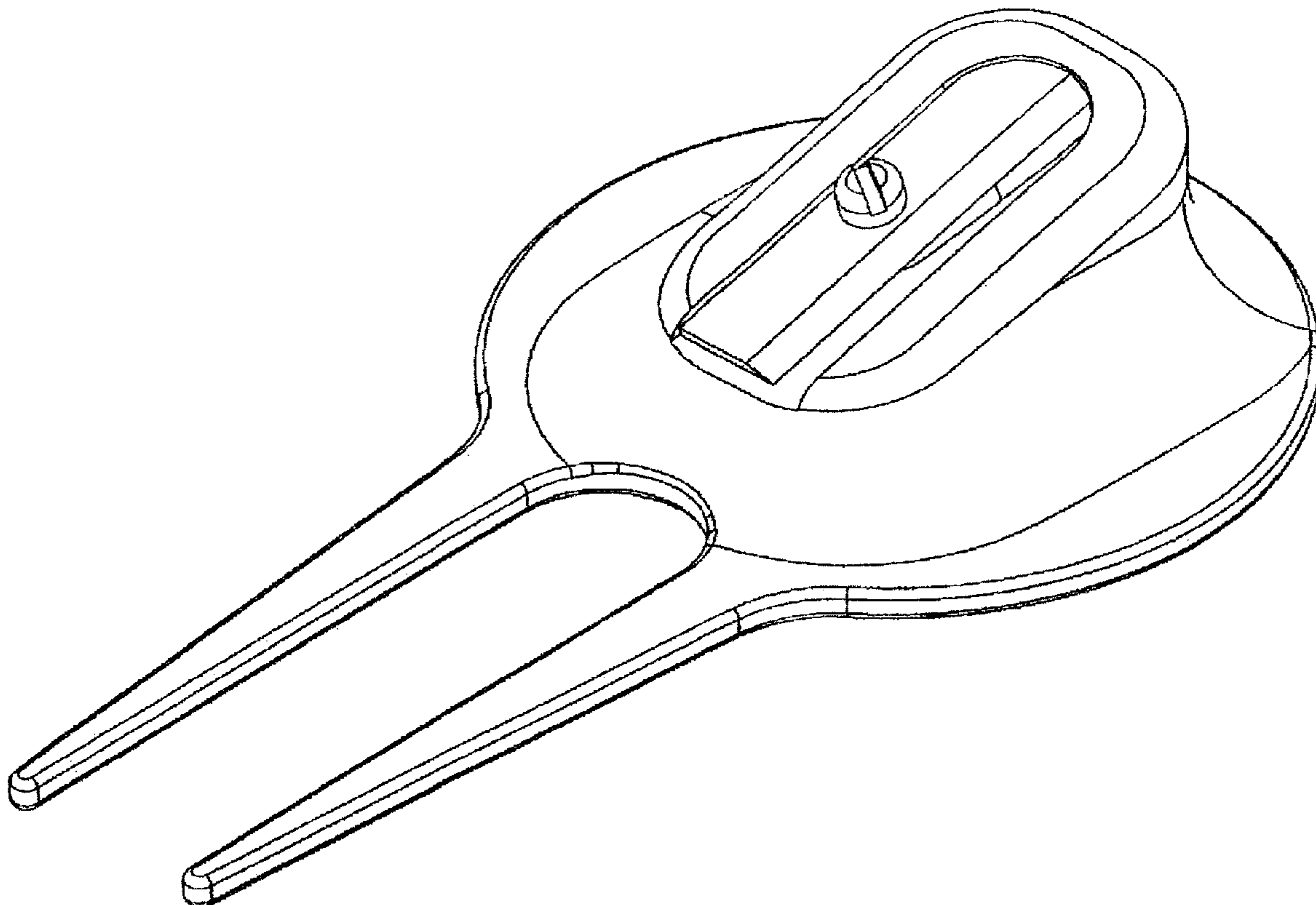

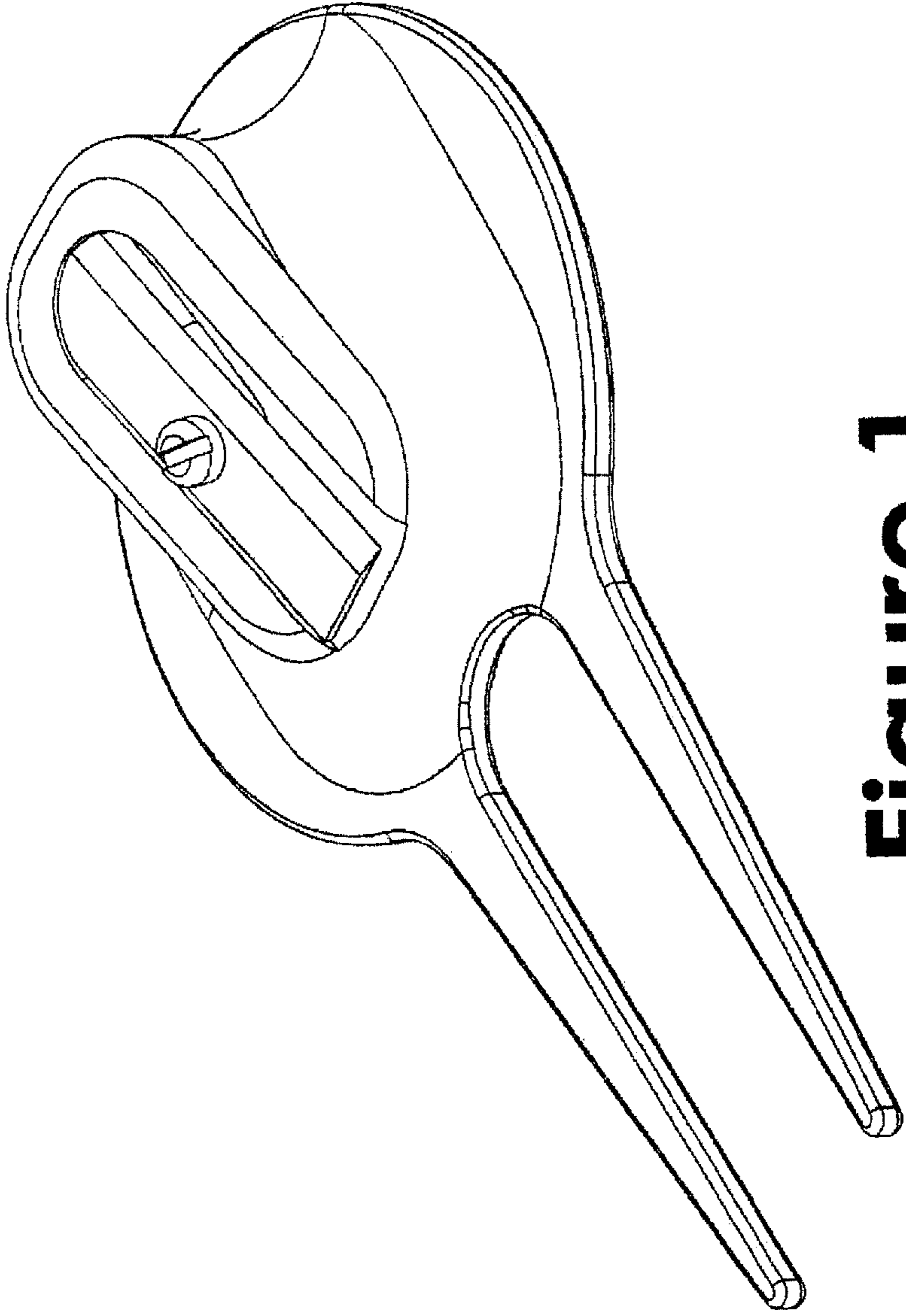

Figure 1

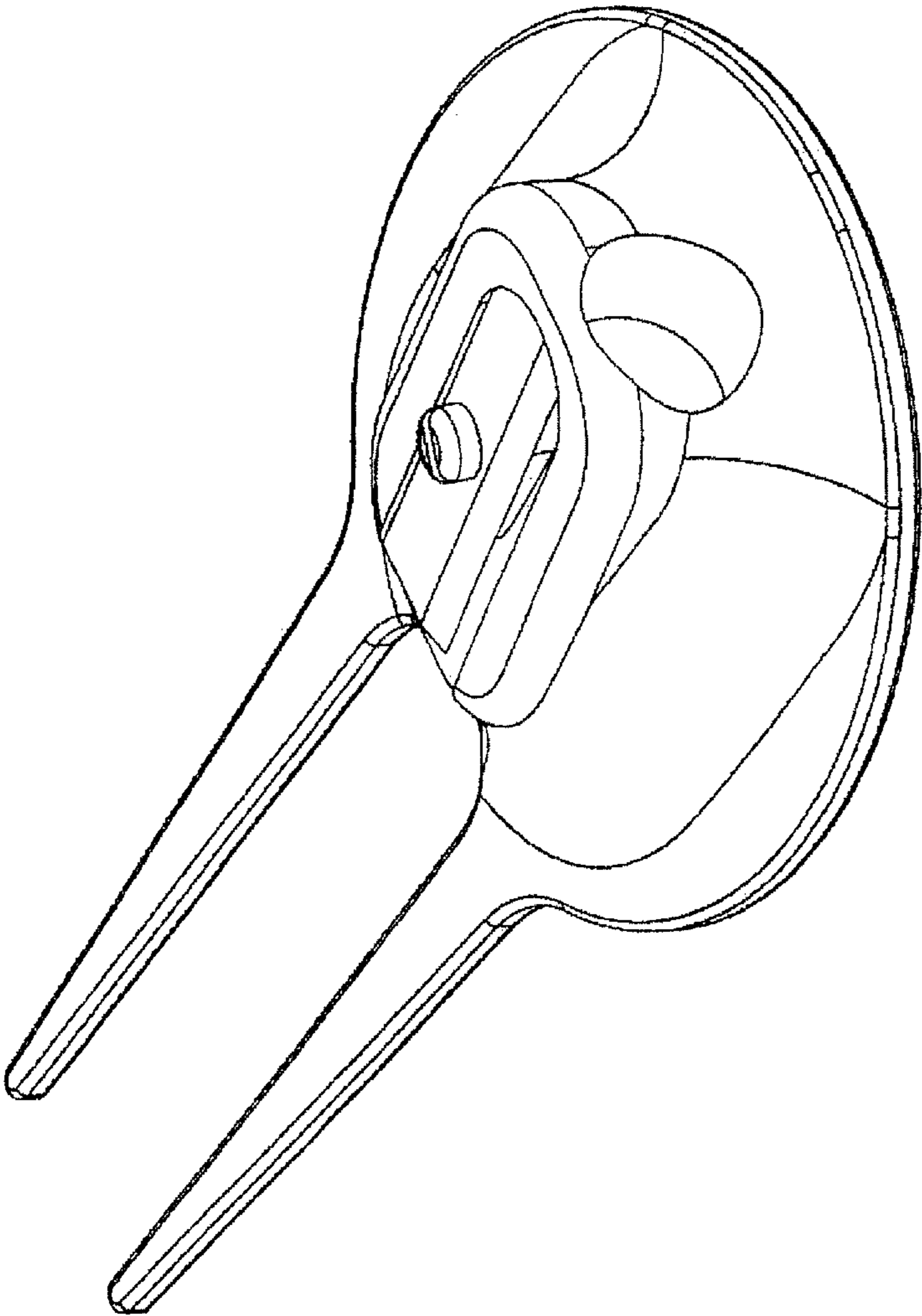

Figure 2

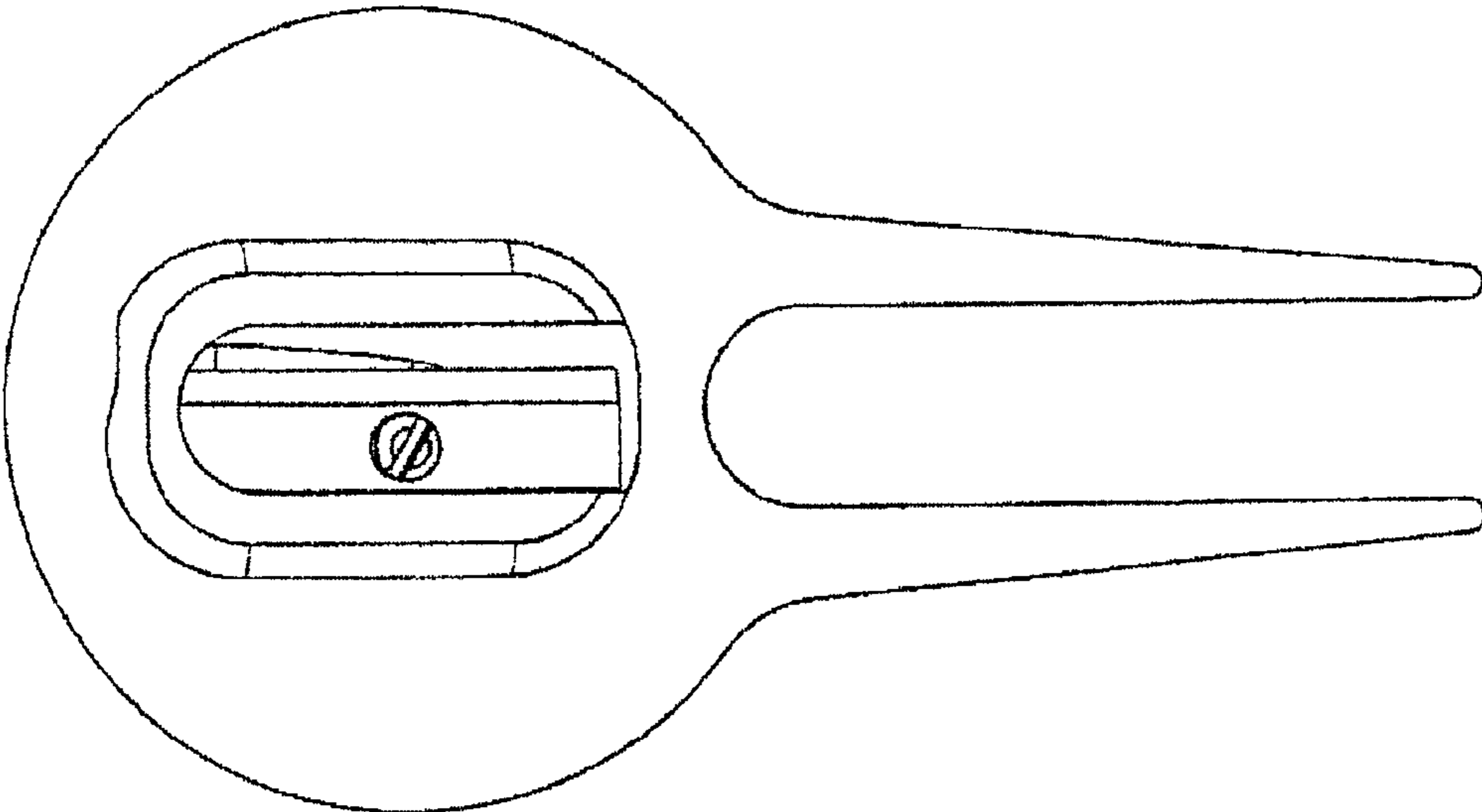

Figure 3

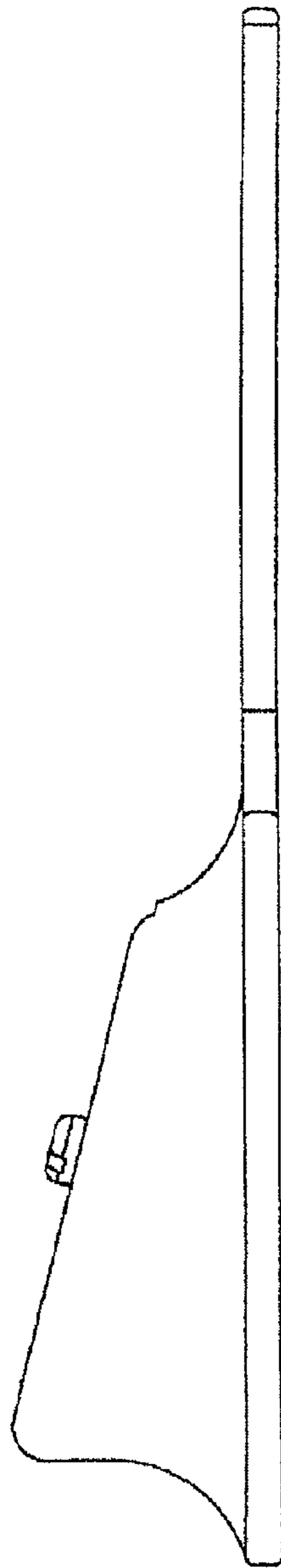

Figure 4

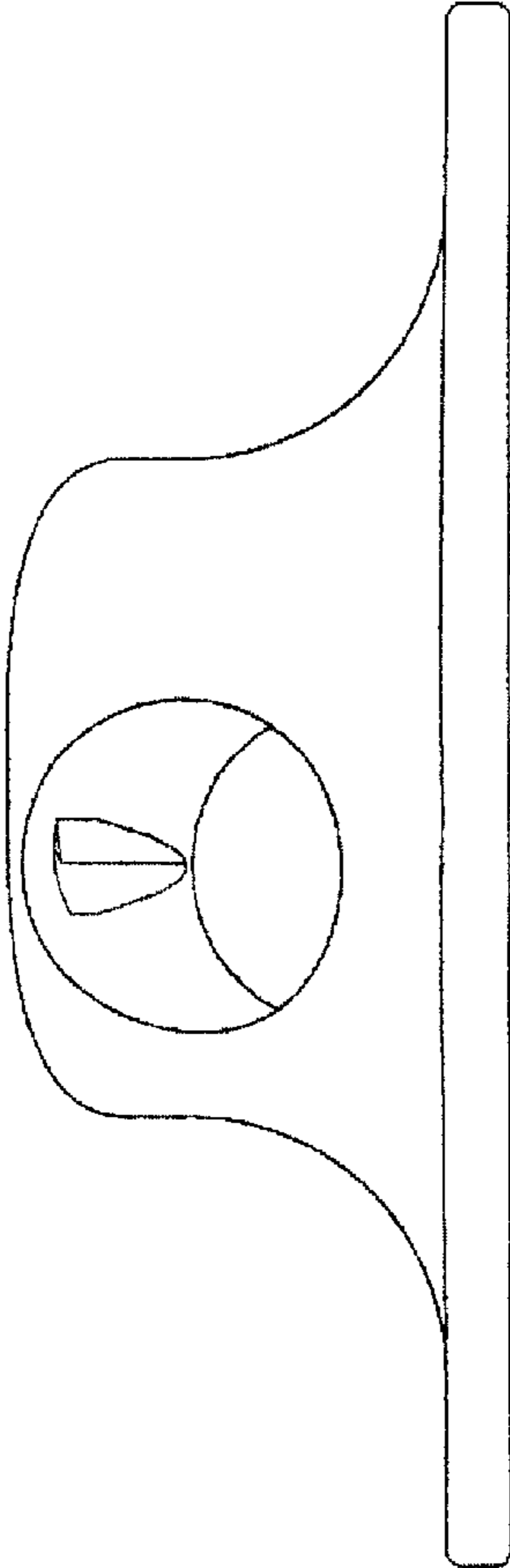

Figure 5

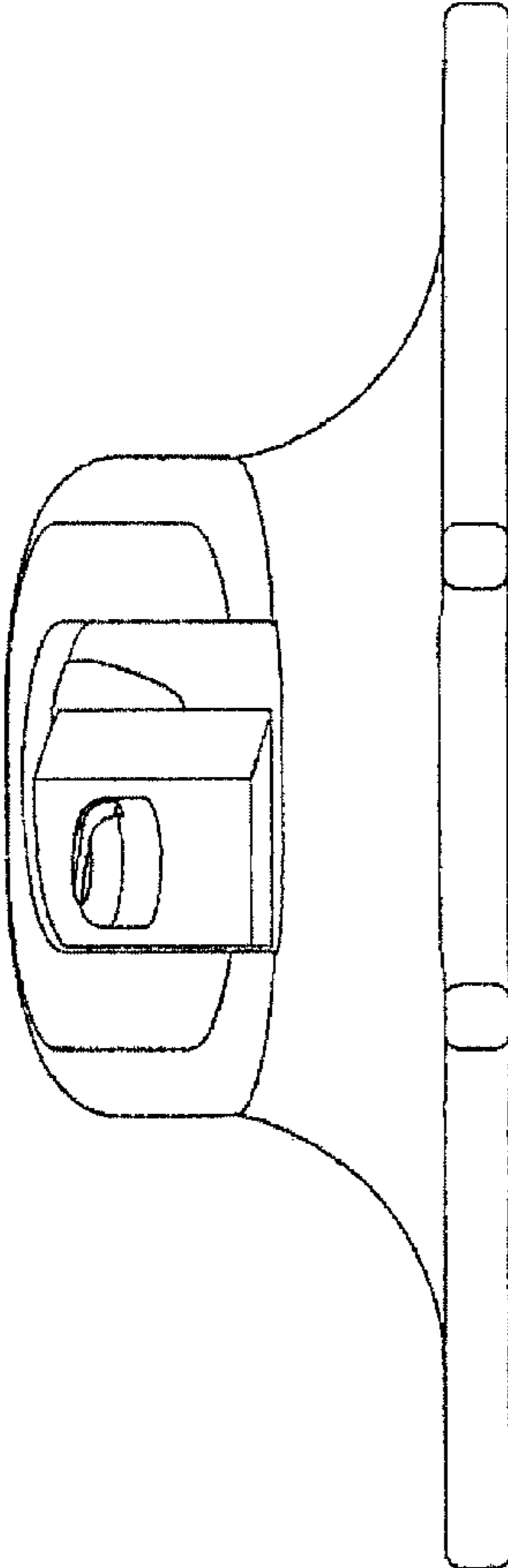

Figure 6